

सी डी एफ डी CDFD

वार्षिक प्रतिवेदन

अप्रैल 2011 से मार्च 2012 तक

ANNUAL REPORT

April 2011 to March 2012

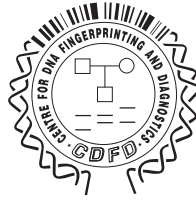

डी एन ए फिंगरप्रिंटिंग एवं निदान केन्द्र

नामपल्ली, हैदराबाद - 500 001

Centre for DNA Fingerprinting and Diagnostics

Nampally, Hyderabad - 500 001

CONTENTS

I	Mandate	5
II	From the Director's Desk	11
III	Services	
	1. Laboratory of DNA Fingerprinting Services	23
	2. Diagnostics Division	26
IV	Research	
	1. Laboratory of Molecular Genetics	37
	2. Laboratory of Genomics and Profiling Applications	45
	3. Laboratory of Fungal Pathogenesis	50
	4. Laboratory of Immunology	55
	5. Laboratory of Bacterial Genetics	60
	6. Laboratory of Computational Biology	72
	7. Laboratory of Molecular Cell Biology	76
	8. Laboratory of Structural Biology	80
	9. Laboratory of Mammalian Genetics	85
	10. Laboratory of Molecular Oncology	89
	11. Laboratory of Cancer Biology	93
	12. Laboratory of Computational and Functional Genomics	97
	13. Laboratory of Transcription	101
	14. Laboratory of Cell Signalling	104
	15. Laboratory of Plant Microbe Interaction	108
	16. Laboratory of Cell Death & Cell Survival	112
	17. Laboratory of Drosophila Neural Development	116
	18. Laboratory of Cell Cycle Regulation	119
	19. Other Scientific Services / Facilities	
	a. Laboratory Animal Facility	125
	b. Bioinformatics	127
	c. Instrumentation	128
V	Publications	129
VI	Human Resource Development	137
VII	Lectures, Meetings, Workshops and Important Events	141
VIII	Deputations Abroad of CDFD Personnel	147
IX	Senior Staff and Officers of CDFD	151
X	Committees of the Centre	155
XI	Implementation of RTI Act, 2005	165
XII	Budget and Finance	171
XIII	Photo Gallery	279

अधिदेश Mandate

अधिदेश

सीडीएफडी सोसाइटी के संगम ज्ञापन तथा नियम एवं विनियमों में बताए गए के अनुसार डीएनए फिंगरप्रिंटिंग एवं निदान केन्द्र की स्थापना जिन उद्देश्यों के लिए हुई वे निम्न प्रकार हैं :

- i. पितृत्व विवाद, आप्रवास और अस्पतालों में नवजात शिशुओं की अदला-बदली जैसे मामलों में निजी पक्षों सहित विविध अभिकरणों के लिए पर्याप्त अदायगी पर डीएनए प्रोफाइलिंग और उससे संबंधित विश्लेषण का वैज्ञानिक अनुसंधान करना।
- ii. अपराध अन्वेषण अभिकरणों को डीएनए फिंगरप्रिंटिंग और उससे संबंधित विश्लेषण तथा सुविधाएँ प्रदान करना।
- iii. अपराध अन्वेषण और परिवार मामलों में डीएनए प्रोफाइल विश्लेषण और उससे संबंधित तकनीकों के साक्ष्य संबंधी मूल्य को समझने में पुलिस कर्मियों, न्यायिक वैज्ञानिकों, वकीलों तथा न्यायपालिका की सहायता करना।
- iv. आनुवंशिक अव्यवस्थाओं को संसूचित करने हेतु डीएनए नैदानिक विधियाँ सिद्ध करना और इस प्रकार के संसूचन के लिए संपरीक्षाएँ विकसित करना।
- v. पादप और जंतु कोशिका माल, कोशिका लाइनों के प्रामाणीकरण के लिए डीएनए फिंगरप्रिंटिंग तकनीकों का उपयोग करना और ऐसे प्रयोजनों के लिए आवश्यकतानुसार नई संपरीक्षाएँ विकसित करना।
- vi. डीएनए फिंगरप्रिंटिंग तकनीकों पर प्रशिक्षण प्रदान करना।
- vii. मूलभूत, अनुप्रयुक्त अनुसंधान एवं विकास कार्य करना।
- viii. देश में चिकित्सा संस्थाओं, जन-स्वास्थ्य अभिकरणों और उद्योग को परामर्शी सेवाएँ प्रदान करना।
- ix. केंद्र के उद्देश्यों से संगत क्षेत्रों में विदेशी अनुसंधान संस्थाओं एवं प्रयोगशालाओं और अन्य अंतर्राष्ट्रीय संगठनों के साथ सहयोग करना।
- x. अनुसंधान छात्रों को स्नातकोत्तर उपाधियों के लिए पंजीकृत कर सकने के प्रयोजन हेतु उच्चतर अधिगम के मान्यता प्राप्त विश्वविद्यालयों एवं संस्थाओं के साथ संबंधन स्थापित करना।
- xi. भारत सरकार, राज्य सरकारों, देश में स्थित पूर्त संस्थाओं/न्यासों, व्यक्तियों और उद्योग से नकद के रूप में या अन्य रूपों में अनुदान, दान एवं अंशदान प्राप्त करना।
- xii. केंद्र सरकार के पूर्व अनुमोदन से प्रशिक्षण कार्यक्रमों, वैज्ञानिक अनुसंधान और अन्य गतिविधियों के लिए अंतर्राष्ट्रीय संगठनों सहित विदेशी स्रोतों से आर्थिक सहायता प्राप्त करना।
- xiii. केंद्र की गतिविधियों को चलाने के लिए जैसा आवश्यक या सुविधाजनक हो, कोई भी संपत्ति चल या अचल या भवनों एवं निर्माणों को निर्मित करने, सुधार करने, परिवर्तित करने, गिरा देने या मरम्मत करने हेतु उपहार, क्रय, विनिमय, पट्टा, भाड़े पर लेने द्वारा या अन्यथा किसी भी तरह अर्जित करना।
- xiv. केंद्र के प्रयोजन हेतु, भारत सरकार और अन्य प्रोनोटों, विनिमय पत्रों, चेक या अन्य परक्राम्य लिखतों को आहरित करना और स्वीकार करना, तैयार करना और पृष्ठांकित करना, बट्टा करना और परक्रामण करना।
- xv. केंद्र को सौंपी गई निधियों या धन को निवेश करने के लिए, ऐसी प्रतिभूतियों को खोलने या ऐसे तरीके से, जो कि समय-समय पर शासी परिषद् द्वारा निर्धारित किए जाते हैं, इस प्रकार के निवेश को विक्रय या पक्षांतरण करना।

- xvi. उक्त सभी उद्देश्यों या उनमें से किसी उद्देश्य की प्राप्ति के लिए सभी ऐसे अन्य विधिसम्मत कार्य, जैसा आवश्यक, प्रासंगिक या सहायक हो, करना।
- xvii. केंद्र के उद्देश्यों को वास्तविक बनाने के लिए प्रोफेसरों अन्य संकाय पदों, अभ्यागत अध्येतावृत्तियों सहित अध्येतावृत्तियों, अनुसंधान एवं संवर्ग पदों, छात्रवृत्तियों आदि को संस्थापित करना।
- xviii. केंद्र के वैज्ञानिक एवं प्रौद्योगिकीय कार्य के लिए प्रयोगशालाओं, कार्यशालाओं, भंडार, पुस्तकालय, कार्यालय और अन्य सुविधाओं को स्थापित करना।
- xix. तकनीकी जानकारी को उद्यमकर्ताओं और उद्योगों से प्राप्त या उनको अंतरण करना; और
- xx. पेटेंटों, डिज़ाइनों एवं तकनीकी जानकारी जो कि केंद्र द्वारा विकसित की गई हो, को पंजीकृत करना और केंद्र के हित में ऐसे पेटेंटों/डिज़ाइनों/तकनीकी जानकारी के किसी भाग को अंतरण करना।

MANDATE

The objectives for which the Centre for DNA Fingerprinting and Diagnostics (CDFD) was established, as enumerated in Memorandum of Association and Rules and Regulations of CDFD Society, are as follows:

- i. To carry out scientific research pertaining to DNA profiling and related analysis in civil cases like paternity disputes, immigration, and exchange of newborns in hospitals, for various agencies including private parties, on appropriate payment;
- ii. To provide DNA fingerprinting and related analysis and facilities to crime investigation agencies;
- iii. To assist police personnel, forensic scientists, lawyers and the judiciary in understanding the evidential value of the DNA profile analysis and related techniques in crime investigation and family matters;
- iv. To establish DNA diagnostic methods for detecting genetic disorders and to develop probes for such detection;
- v. To use DNA fingerprinting techniques for the authentication of plant and animal cell material, cell lines and to develop new probes where necessary for such purposes;
- vi. To provide training in DNA fingerprinting techniques;
- vii. To undertake basic, applied and developmental R & D work;
- viii. To provide consultancy services to medical institutions, public health agencies and industry in the country;
- ix. To collaborate with foreign research institutions and laboratories and other international organizations in fields relevant to the objectives of the Centre;
- x. To establish affiliation with recognized universities and institutions of higher learning for the purpose of enabling research scholars to register for post-graduate degrees;
- xi. To receive grants, donations and contributions in cash or in other forms from the Government of India, State Governments, Charitable Institutions/Trusts, individuals and industry within the country;
- xii. To receive, with the prior approval of the Central Government, monetary assistance from foreign sources including international organizations for training programmes, scientific research and other activities;
- xiii. To acquire by gift, purchase, exchange, lease, hire or otherwise howsoever, any property movable or immovable or to construct, improve, alter, demolish or repair buildings and structures as may be necessary or convenient for carrying on the activities of the Centre;
- xiv. For the purpose of the Centre, to draw and accept, make and endorse, discount and negotiate Government of India and other Promissory Notes, Bills of Exchange, Cheques or other Negotiable Instruments;

- xv. For investing the funds of or money entrusted to the Centre, to open such securities or in such manner as may from time to time be determined by the Governing Council and to sell or transpose such investment;
- xvi. To do all such other lawful acts as may be necessary, incidental or conducive to the attainment of all or any of the above objectives;
- xvii. To institute Professorships, other faculty positions, fellowships including visiting fellowships, research and cadre positions, scholarships, etc. for realizing the objectives of the Centre;
- xviii. To establish, maintain and manage laboratories, workshops, stores, library, office and other facilities for scientific and technological work of the Centre;
- xix. To acquire or transfer technical know-how from/to entrepreneurs and industries; and
- xx. To register patents, designs & technical know-how that may be developed by the Centre and transfer any portion of such patents/designs/technical know-how in the interest of the Centre.

निदेशक का संदेश
From the Director's Desk

निदेशक का संदेश



अप्रैल 2011 से मार्च 2012 की अवधि के लिए इस केंद्र की वार्षिक रिपोर्ट को प्रस्तुत करते हुए और वर्ष-भर की हमारी अनुसंधान गतिविधियों का संक्षिप्त विवरण देते हुए मुझे गर्व का अनुभव हो रहा है। यह संस्थान आनुवंशिक बीमारियों के लिए डीएनए प्रोफाइलिंग और नैदानिक परीक्षण के क्षेत्रों में सेवाएँ और प्रशिक्षण प्रदान करता है और आधुनिक आणविक जीव विज्ञान के विविध क्षेत्रों में मूलभूत अनुसंधान का नेतृत्व करता है। इस केंद्र पर उच्च-कोटि की सेवाओं और अनुसंधान का यह मिश्रण एक ऐसे अनुपम नमूने के रूप में उभरा है जो कि सामाजिक प्रासंगिकता के साथ जुड़े शैक्षिक उत्कृष्टता के लिए प्रयासरत रहता है।

अगले पन्नों में, हम आपको इस रिपोर्टाधीन वर्ष के दौरान जनता को दी गई सेवाओं और मूलभूत अनुसंधान में अपनी प्रगति की एक झलक दिखाते हैं।

रिपोर्टाधीन वर्ष के दौरान, हमने करीब-करीब एक सौ मामलों के लिए डीएनए प्रोफाइलिंग सेवाएँ प्रदान की और विविध राज्य और केंद्र सरकार की एजेंसियों को प्रशिक्षण दिया। नैदानिकी की सेवाओं के क्षेत्र में, निज़ाम आयुर्विज्ञान संस्थान (निम्स), हैदराबाद के साथ किए गए समझौता ज्ञापन के अंतर्गत स्थापित चिकित्सा आनुवंशिकी एकक में 2000 से भी अधिक रोगियों ने आनुवंशिक मूल्यांकन कराया और सलाह मशविरा लिया। इस संबंध की दूसरी महत्वपूर्ण कड़ी के रूप में निम्स में चिकित्सा आनुवंशिकी विभाग की स्थापना और उस विभाग में दो अतिरिक्त संकाय सदस्यों की भर्ती की गई थी। इस वर्ष एपीईडीए-सीडीएफडी बासमती डीएनए विश्लेषण केंद्र ने लगभग 160 बासमती चावल नमूनों का उनकी शुद्धता के लिए परीक्षण किया।

आणविक आनुवंशिकी प्रयोगशाला ने सफलता से बाकुलोविषाणु और रेशमकीटों से एमआईआरएनएज़ और उनके लक्ष्यों की पहचान की और मान्यकरण किया, इस प्रकार से जटिल परपोषी-विषाणुज अंतःक्रियाओं के बारे में रोचक परिज्ञान प्रदान किया। इस समूह ने ऐसे ट्रान्सजेनिक रेशमकीटों को उत्पन्न किया जो बाकुलोविषाणु के प्रति प्रतिरोधक हैं और इस प्रतिरोधकता गुणधर्म को एक वाणिज्यिक, उच्च उपज बाकुलोविषाणु ग्रहणशील रेशमकीट प्रभेद में अंतरित किया।

आणविक अर्बुदशास्त्र प्रयोगशाला में किए गए अध्ययनों ने बताया कि शीघ्र-आरंभ मलाशयी कैंसरों में ज्यादातर भाग नवीन गैर-डब्ल्यूएनटी गैर-एमएसआई आनुवंशिक अस्थिरता पैथवेज़ द्वारा चालित गुणसूत्री अस्थिरता दिखाते हैं। स्तनी आनुवंशिकी पर अनुसंधान ने कैंसरजनन और विकास में डीएनए मेथिलट्रान्सफरेसेस डीएनएमटी3एल एवं डीएनएमटी2 की भूमिका का सूक्ष्म परीक्षण किया। एम. ट्यूबरकुलोसिस से चुनौती देने पर परपोषी कोशिका जिन पशुजात परिवर्तनों से गुजरती है, उन की भी पहचान इस समूह ने की। ग्रीवा कैंसर बढ़ाव की प्रक्रिया को समझने के लिए, कैंसर जैविकी प्रयोगशाला सेरीन/थ्रिऑनीन फॉस्फाटस, कैल्सीनूरीन और उसके भेषजगुण संबंधी संदमकों की भूमिका पर शोध कर रही है। आणविक कोशिका जैविकी प्रयोगशाला ने प्रतिवेदित किया कि माइकोबैक्टीरियल पीपीई प्रोटीन आरवी1168सी, टीएलआर2-एलआरआर-एनएफ-केबी संकेतन सोपानियों को एक टैट-स्वतंत्र तरीके में मॉडुलित करके एचआईवी-1 एलटीआर से अनुलेखन को बढ़ा सकता है। यह सूचना एम. ट्यूबरकुलोसिस सह-संक्रमण के दौरान एचआईवी-1 के रोगजनन की क्रियाविधि को समझने में मदद कर सकती है।

अनुलेखन प्रयोगशाला एशेरिशिया कोलाई में कारक-आश्रित अनुलेखन समापन और प्रतिसमापन के आणविक आधार को समझने में लगी हुई है, और जीवे रो-आश्रित अनुलेखन समापन में गतिज-युगमन की मौजूदगी को सिद्ध किया गया। यह निरूपण किया गया कि रो एन-व्यवहित प्रतिसमापन को पराजित करने के लिए एक बहु-दीर्घ कार्यनीति अपनाता है। इस प्रयोगशाला ने षट्तीय रो पर जीवाणुभोजी प्रोटीन पीएसयू के संलगनी स्थल की पहचान की। इसी संदर्भ में, जीवाणविक आनुवंशिकी प्रयोगशाला ने दर्शाया कि जीवाणु में रो-आश्रित समापन आरएनए-डीएनए संकरों (आर-लूप्स) के जीनोम-व्यापी निवारण के लिए आवश्यक है। इस समूह ने ग्राम-अग्राही ई. कोलाई और ग्राम-ग्राही कोरीनेबैक्टीरियम ग्लुटामिकम के बीच अनुलेखनीय प्रतीप-नियमन की उपस्थिति को भी पहली बार, दोनों जीवों के लिए क्रमशः आर्ज पी-आर्ज ओ और लाइस जी-लाइस ई ऑर्थोलोगस प्रणालियों का इस्तेमाल करके दर्शाया।

कोशिका संकेतन प्रयोगशाला ने निरूपित किया कि आर्डपी₇, आरएनए पॉलिमरेस 1 के घटकों को पाइरोफॉस्फोरिलीकरण करने के द्वारा यीस्ट में राइबोसोम जीवोत्पत्ति को नियमित करता है और इस प्रकार से आर आरएनए संश्लेषण को नियंत्रित करता है। यह देखते हुए कि अर्धसूत्रण प्रभावित नहीं हुआ, लेकिन अगुणित प्रशुक्राणु प्रौढ़ शुक्राणु के रूप में विकसित नहीं होते हैं, इस समूह ने आर्डपी₆के1 नॉकआउट मूषकों में नर बंध्यता के अंतर्निहित कोशिकीय दोषों का अभिलक्षणन करना भी आरंभ किया है।

माइक्रोबैक्टीरियम ट्यूबरकुलोसिस वर्धक पूर्वानुमान के लिए एक बेज़ियन मशीन अधिगम नमूना अभिकलनी और प्रकार्यात्मक जीनोमिकी प्रयोगशाला द्वारा तैयार किया गया। मूत्ररोगजनक ई. कोलाई पर काम करते हुए, इस समूह ने दर्शाया कि होस ए प्रोटीन कशाभी हुक प्रोटीन फ्लिक सी के अपस्ट्रीम क्षेत्र से बंध्यता है। अभिकलनी जैविकी समूह ने मानव-एचआईवी ब्रिज़ नेटवर्क का विश्लेषण किया और यह स्पष्ट किया गया कि कई विषाणुज प्रोटीन संधि बिन्दुओं के रूप में काम करते हैं जो कि मानव प्रोटीन-प्रोटीन अंतःक्रिया नेटवर्कों के न जुड़े घटकों को जोड़ते हैं।

कवकीय रोगजनन प्रयोगशाला ने दिखाया कि प्रोटीन काइनेस सी संकेतन का स्टॉरोस्पोरीन-व्यवहित संदमन और एक संरक्षित हीट-शॉक प्रोटीन एचएसपी90 के गेंडानामाइसिन-व्यवहित प्रकार्यात्मक संदमन ने फ्लुकोनजोल को कवकनाशी बना दिया। पादप सूक्ष्मजीव अंतःक्रिया प्रयोगशाला के समूह ने जैन्थोमोनास ऑरिऑजी पीवी ऑरिज़ी में नए उग्रता प्रकार्यों की पहचान की जो विसरणीय संकेत कारक (डीएसएफ) द्वारा नियमित हैं। यह स्पष्ट किया गया कि उच्च डीएसएफ स्तर गतिशीलता को निरोधित कर सकते हैं और जैव फिल्म निर्माण को बढ़ावा देते हैं, जब कि उसके निम्न स्तर गतिशीलता और रासायनिक अनुचलन को बढ़ावा देते हैं और पादपों में डीएसएफ स्तरों के इस तरह के माडुलन को रोगाणु के फैलने से रोकने और बीमारी बढ़ जाने को सीमित रखने के लिए एक कार्यनीति के रूप में उपयोग किया जा सकता है।

जीनोमिकी और प्रोफाइलिंग अनुप्रयोग प्रयोगशाला मानव पहचान के लिए एकल न्यूक्लिओटाइड बहुरूपता आधारित पैनल को तैयार करने की दिशा में काम करती आ रही है जो विकृत न्यायिक नमूनों का जीनप्रारूपण करने में उपयोगी सिद्ध होगा। हमारे नए संकाय सदस्यों ने कोशिका चक्र नियमन, कोशिका मरण और कोशिका उत्तरजीविता, और ड्रॉसोफिला तंत्रिका विकास पर उत्तेजक कार्य आरंभ किया।

केंद्र की उपलब्धियों के पैमाने के रूप में, हमारे संकाय एवं छात्रों ने इस वर्ष अनेक पुरस्कार और सम्मान प्राप्त किए। इनमें वेल्कम ट्रस्ट डीबीटी इण्डिया अलायन्स से फेलोशिप, पश्चिम बंगाल विज्ञान एवं प्रौद्योगिकी अकादमी और आंध्र प्रदेश विज्ञान अकादमी की फेलोशिप, नवोन्मेषी युवा जैवप्रौद्योगिकी पुरस्कार और अमरीकी सूक्ष्मद्रवी सोसाइटी का मोसेलिओ स्कैचटर विशिष्ट सेवा पुरस्कार शामिल थे। समकक्ष-समीक्षित अंतर्राष्ट्रीय जर्नलों में बहुसंख्या में उच्च गुणता के प्रकाशन, जैसा कि वार्षिक प्रतिवेदन में सूची दी गई है, मूलभूत अनुसंधान में केंद्र की प्रगति को प्रमाणित करते हैं। रिपोर्टाधीन अवधि के दौरान, इस केंद्र के छः शोधार्थियों ने मणिपाल विश्वविद्यालय से पीएचडी उपाधि प्राप्त की। हर साल यह केंद्र पर्याप्त प्रशिक्षित मानव संसाधन को तैयार करने और अग्रणी अनुसंधान की आवश्यकताओं की पूर्ति करने के लिए पूरे देश से बड़ी संख्या में उज्ज्वल, उत्साही अनुसंधान फेलो और प्रशिक्षणार्थियों को आकर्षित करता है।

प्रतिरक्षाविज्ञान, कैंसर जैविकी, फैलने वाली बीमारियाँ आदि क्षेत्रों में जैविकीय अनुसंधान को आधार देने के लिए, सीडीएफडी ने शामीरपेट (नामपल्लि के वर्तमान अंतरिम परिसर से ~45 किमी) में मेसर्स विमटा लैब्स में अपनी प्रयोगशाला जंतु सुविधा स्थापित की उस सुविधा को चलाने के लिए दो कर्मियों की भर्ती की। केंद्र के पास जो परिष्कृत

उपस्कर हैं, वे पूरे देश के अनुसंधानकर्ताओं के उपयोग के लिए एक विशिष्ट उपस्कर प्रचालन बहिःस्रोतन व्यवस्था के जरिए उपलब्ध हैं।

भारत सरकार के विज्ञान एवं प्रौद्योगिकी मंत्रालय के विज्ञान एवं प्रौद्योगिकी विभाग की पहल से, सीडीएफडी ने अप्रैल 2011 में भारतीय सर्वेक्षण (एस ओ आर्इ) के साथ एक समझौता ज्ञापन किया जिसके द्वारा केंद्र अपना नए परिसर का निर्माण एस ओ आर्इ के 20 एकड़ जमीन में आरंभ कर रहा है। वास्तु फर्म और परियोजना प्रबंध परामर्शदाता का चयन हो गया है और शीघ्र ही निर्माण गतिविधियाँ आरंभ होने की आशा है।

मैं अपने सभी वैज्ञानिक, तकनीकी और प्रशासनिक सहकर्मियों और विद्यार्थियों के प्रति बहुत आनंद के साथ आभार प्रकट करता हूँ, जिन्होंने इस केंद्र की उन्नति और प्रतिष्ठा को विकसित करने में जोश भरे योगदान दिए और अथक प्रयास किए। हम जैवप्रौद्योगिकी विभाग, सीडीएफडी सोसाइटी के विशिष्ट सदस्य, शासी परिषद्, अनुसंधान क्षेत्र-पैनेल-वैज्ञानिक सलाहकार समिति, प्रबंध समिति, वित्त एवं भवन समितियों को भी उनके प्रोत्साहन, सलाह और संपूर्ण समर्थन के लिए हार्दिक धन्यवाद देते हैं। उनकी गहरी रुचि, उत्कृष्ट सहयोग के बिना, हमारी अधिकांश उपलब्धियाँ संभव नहीं हो पाती। हम, साथ मिलकर, इस संस्थान को आने वाले वर्षों में और अधिक ऊँचाइयों तक ले जाने के लिए प्रयत्नशील रहेंगे।

ज गौरीशंकर

मार्च 31, 2012

Director's Message



It is my privilege to present the Annual Report of this Centre for the period April 2011 to March 2012 and submit a concise narration of our year-long research activities. This Institute provides services and training in the areas of DNA profiling and diagnostic testing for genetic diseases, and also spearheads basic research in diverse areas of modern molecular biology. This combination of high-calibre services and research at the Centre has emerged as a unique model that strives for academic excellence knitted with social relevance.

In the following pages, we offer you a glimpse of our progress in basic research and of the services we have rendered to the public during the reporting year.

During the period under report we provided DNA profiling services for almost a hundred cases and rendered training to various State and Central government agencies. In the area of Diagnostic services, more than 2000 patients underwent genetic evaluation and counselling at the Medical Genetics Unit that has been established as part of the Memorandum of Understanding with the Nizam's Institute of Medical Sciences (NIMS), Hyderabad. Another milestone in this association was establishment of the Department of Medical Genetics (DMG) at NIMS, and appointment of two additional faculty members in the Department. This year, the APEDA-CDFD Centre for Basmati DNA Analysis tested around 160 basmati rice samples for their purity.

The Laboratory of Molecular Genetics has successfully identified and validated miRNAs and their targets from baculovirus and silkworm genomes, thereby providing interesting insight into the complex host-viral interactions. This group has generated transgenic silkworms which are resistant to the baculovirus and have transferred this resistance property to a commercial, high yielding baculovirus susceptible silkworm strain.

The studies at Molecular Oncology Laboratory have revealed that a significant proportion of early-onset rectal cancers exhibit chromosomal instability driven by novel non-Wnt non-MSI genetic instability pathways. The research on Mammalian Genetics has dissected out the role of DNA methyltransferases *Dnmt3l* and *Dnmt2* in carcinogenesis and development. This group has also identified epigenetic changes that the host cell undergoes when challenged with *M. tuberculosis*. In order to understand the process of cervical cancer progression, the Laboratory of Cancer Biology is exploring the role of serine/threonine phosphatase, calcineurin and its pharmacological inhibitors. The Laboratory of Molecular Cell Biology has reported that the mycobacterial PPE protein Rv1168c can augment transcription from HIV-1 LTR by modulating the TLR2-LRR-NF- κ B signalling cascades in a tat-independent manner. This information may help in understanding the mechanism of pathogenesis of HIV-1 during *M. tuberculosis* co-infection.

The Laboratory of Transcription is engaged in understanding the molecular basis of factor-dependent transcription-termination and antitermination in *Escherichia coli*, and has shown the existence of kinetic-coupling in the *in-vivo* Rho-dependent transcription termination. It has been demonstrated that Rho

employs a multi-prolonged strategy to overcome N-mediated antitermination. This laboratory has identified the docking site of a bacteriophage protein *Psu* on the hexameric Rho. In a related context, the Laboratory of Bacterial Genetics has shown that Rho-dependent termination in bacteria is essential for the genome-wide prevention of RNA-DNA hybrids (R-loops). This group has also shown for the first time the occurrence of transcriptional cross-regulation between Gram-negative *E.coli* and Gram-positive *Corynebacterium glutamicum*, by using the *ArgP-argO* and *LysG-lysE* orthologous systems from the two organisms, respectively.

The Cell Signalling group has demonstrated that IP₇ regulates ribosome biogenesis in yeast by pyrophosphorylating components of RNA polymerase I, and thereby controlling rRNA synthesis. This group has also started characterization of cellular defects underlying male infertility in IP6K1 knockout mice, noting that meiosis is unaffected, but haploid spermatids do not develop into mature spermatozoa.

A Bayesian machine learning model for *Mycobacterium tuberculosis* promoter prediction has been created by the Computational and Functional Genomics Laboratory. Working with uropathogenic *E. coli*, this group has shown that the *HosA* protein binds to the upstream region of flagellar hook protein *fliC*. The Computational Biology group has analysed the human-HIV bridge network, and it has been revealed that several viral proteins act as articulation points that connect the unconnected components of human protein-protein interaction networks.

The Laboratory of Fungal Pathogenesis has demonstrated that staurosporine-mediated inhibition of protein kinase C signalling and gendanamycin-mediated functional inhibition of a conserved heat-shock protein Hsp90, rendered fluconazole fungicidal. The group in the Laboratory of Plant Microbe Interactions has identified new virulence functions which are regulated by the Diffusible Signal Factor (DSF) in *Xanthomonas oryzae* pv *oryzae*. It has been revealed that high DSF levels can suppress motility and promote biofilm formation, while its low levels promote motility and chemotaxis and that such modulation of DSF levels in plants can be used as a strategy to prevent spread of pathogen and restrict disease development.

The Laboratory of Genomics and Profiling Applications has been working towards devising a single nucleotide polymorphism based panel for human identification which would be useful in genotyping the degraded forensic samples. Our relatively new faculty members have initiated exciting work on cell cycle regulation, cell death and cell survival, and *Drosophila* neural development.

As a measure of the Centre's achievements, our faculty and students were recipients of several awards and honours this year. These have included Fellowship from Wellcome Trust DBT India Alliance, Fellowships of the West Bengal Academy of Science & Technology and of the Andhra Pradesh Akademi of Sciences, Innovative Young Biotechnologist Awards, and Moselio Schaechter Distinguished Service Award of the American Society of Microbiology. A significant number of high quality publications in peer-reviewed international journals, as listed in the Annual Report, testify to the Centre's progress in basic research. During the reporting period, six research scholars of the Centre were awarded PhD by the University of Manipal. Every year, the Centre attracts a large number of bright, enthusiastic research fellows and trainees from all over the country to generate adequate trained human resource and to fulfil the requirements of cutting edge research.

In order to support biological research in the areas like immunology, cancer biology, infectious diseases etc., CDFD has established its Laboratory Animal Facility at M/s Vimta Labs Limited in Shamirpet (~45 kms from the current, interim campus at Nampally) and has recruited two personnel to operate the facility. The sophisticated equipments in the Centre's possession are also available for use by researchers all over the country through a unique equipment operation outsourcing arrangement.

At the initiative of the Department of Science and Technology, Ministry of Science and Technology, Government of India, CDFD has entered into an MoU with the Survey of India (Sol) in April 2011 through which the Centre is initiating the construction of its new campus in 20 acres of Sol's land at Uppal, Hyderabad. The selection of architect firm and project management consultant has been completed and it is expected that the construction activities would commence shortly.

It is my pleasure to acknowledge all my scientific, technical and administrative colleagues and students for their passionate contributions and tireless efforts in nurturing the growth and reputation of the Centre. We also extend our sincere thanks to the Department of Biotechnology, distinguished members of the CDFD Society, Governing Council, Research Area Panels-Scientific Advisory Committee, Management Committee, Finance and Building Committees for their encouragement, advice and unstinted support. Without their keen interest and outstanding cooperation, much of our accomplishments would not have been possible. We, together, shall strive to carry this Institute to ever higher accomplishments in the coming years.

J Gowrishankar

March 31, 2012

सेवाएँ
Services

LABORATORY OF DNA FINGERPRINTING SERVICES

Scientist-In-Charge	Madhusudan R Nandineni	Staff Scientist
Other Members	SPR Prasad Ch V Goud DS Negi Ch Annapurna Devinder Kumar Sanjukta Mukerjee Chandra Shekhar Singh Vijay Girnar Amrutarao	Senior Technical Officer Technical Officer II Technical Officer II Technical Officer I (Till Dec. 2011) Technical Officer II (Since Oct. 2011) Technical Officer II (Since Nov. 2011) Technical Assistant (Since Oct. 2011) Technical Assistant
Co-ordinator	J Nagaraju	Staff Scientist

Objectives

1. To provide DNA fingerprinting services in cases forwarded by law-enforcing agencies and judiciary of State and Federal Governments, relating to murder, rape, paternity, maternity, child swapping, body identification, kidney transplantation, etc.;
2. To develop human resources skilled in DNA fingerprinting, to cater to the needs of State and Federal Government agencies;
3. To impart periodical training to manpower involved in DNA fingerprinting sponsored by State and Federal Government agencies;
4. To provide advisory services to State and Federal Government agencies in establishing DNA fingerprinting facility;
5. To create DNA marker databases of different caste populations of India.

Summary of services provided until the beginning of the reporting year (April 1, 2010 - March 31, 2011)

A total number of 112 cases were received for DNA fingerprinting examination during the above mentioned period. Out of these, 40 cases were related to paternity / maternity, 57 cases were related to identification of deceased, 8 cases were pertaining to sexual assault (rape), 4 cases were related to murder and 3 cases pertaining to biological relationship (kidney transplantation). Fourteen States and Union Territories of India availed DNA fingerprinting services of CDFD during this period. Rajasthan forwarded the highest number of cases (37) followed by Uttar Pradesh (18), Andhra Pradesh (16), Karnataka (10), Punjab (10), Chhattisgarh (9), Maharashtra (4), Madhya

Pradesh (2), Andaman & Nicobar Islands (1), Bihar (1), Daman & Diu (1), Puducherry (1), Tamil Nadu (1) and Uttarakhand (1).

Details of services provided in the current reporting year (April 1, 2011 - March 31, 2012)

Break-up of the cases during this reporting period is given below under following heads:

Biological Relationship	3
Identity of Deceased	33
Paternity/Maternity	50
Sexual Assault (Rape)	5
Murder	3
Total number of cases	94

(a) Deposition of evidence in Courts of Law

During this reporting year, the DNA experts defended their reports in five cases in various Hon'ble Courts throughout the Country.

(b) Training/Lectures/Workshops on DNA fingerprinting examination

(i) Training

1. Training in DNA fingerprinting techniques to the scientific personnel from the State Forensic Science Laboratory, Lucknow, Uttar Pradesh from 20.6.2011 to 25.6.2011.
2. Training in DNA fingerprinting techniques to Post-graduate fellows from the Department of Forensic Medicine, Andhra Medical College, Visakhapatnam, Andhra Pradesh in November 2011.
3. Training in DNA fingerprinting techniques to personnel from Forensic Science Laboratory, Govt. of NCT of Delhi from 14.3.2012 to 30.4.2012.

(ii) Lectures/Workshops

1. Delivered lecture for the benefit of the Judicial Officials from Andhra Pradesh Judicial Academy, Secunderabad in April 2011.
2. Delivered lecture for the benefit of the Judicial Officials from Andhra Pradesh Judicial Academy, Secunderabad in June 2011.
3. Delivered lecture for the benefit of the Police Probationers from North East Police Academy, Delhi in July 2011.
4. Delivered lecture for the benefit of the students from Tamil Nadu Agricultural University, Coimbatore, Tamil Nadu in August 2011.
5. Coordinated in conducting the "Promega DNA Typing Workshop Forum" conducted by Promega Corp. Pvt. Ltd. at CDFD from 11 to 13 November 2011 for the benefit of scientific personnel from various Forensic Science Laboratories across the Country.
6. Delivered lecture for the benefit of the Air Force Officers from Air Force Intelligence School, Lohegaon, Pune on 7.2.2012.

7. Lecture was delivered for the benefit of the students at the Department of Genetics, Osmania University College for Women, Hyderabad on 15.2.2012.
8. Delivered lecture for the benefit of the students at St. Pious X PG College for Women, Hyderabad on 27.3.2012.

(c) National Visits

1. Delivered a lecture for the benefit of the students at P B Siddhartha College of Arts & Science, Vijayawada, Andhra Pradesh on 21.1.2012.
2. Provided hands on training and delivered talk on DNA fingerprinting techniques at the State Forensic Science Laboratory, Sagar, Madhya Pradesh during 22 to 26 November 2011.

A total number of 94 cases were received for DNA fingerprinting examination during the current reporting period. Of these, 50 cases related to paternity / maternity, 33 cases relate to identification of deceased, 5 cases were pertaining to sexual assault (rape), 3 cases were related to murder and 3 cases pertaining to biological

Summary of the state-wise break-up of DNA fingerprinting cases

State/Union Territory	Biological Relationship	Identity of Deceased	Maternity/ Paternity	Murder	Sexual Assault (Rape)	No. of Cases
Andaman & Nicobar Islands		1	1			2
Andhra Pradesh	3	16	12		2	33
Bihar			3			3
Chhattisgarh		3	7		2	12
Delhi		1	1	1		3
Jammu & Kashmir		2				2
Jharkhand		1				1
Karnataka		1	9			10
Kerala			6			6
Madhya Pradesh			1			1
Maharashtra			3			3
Orissa			1			1
Puducherry			1			1
Punjab		5	4		1	10
Tamil Nadu				1		1
Uttar Pradesh		3		1		4
Uttarkhand			1			1
Total number of cases	3	33	50	3	5	94

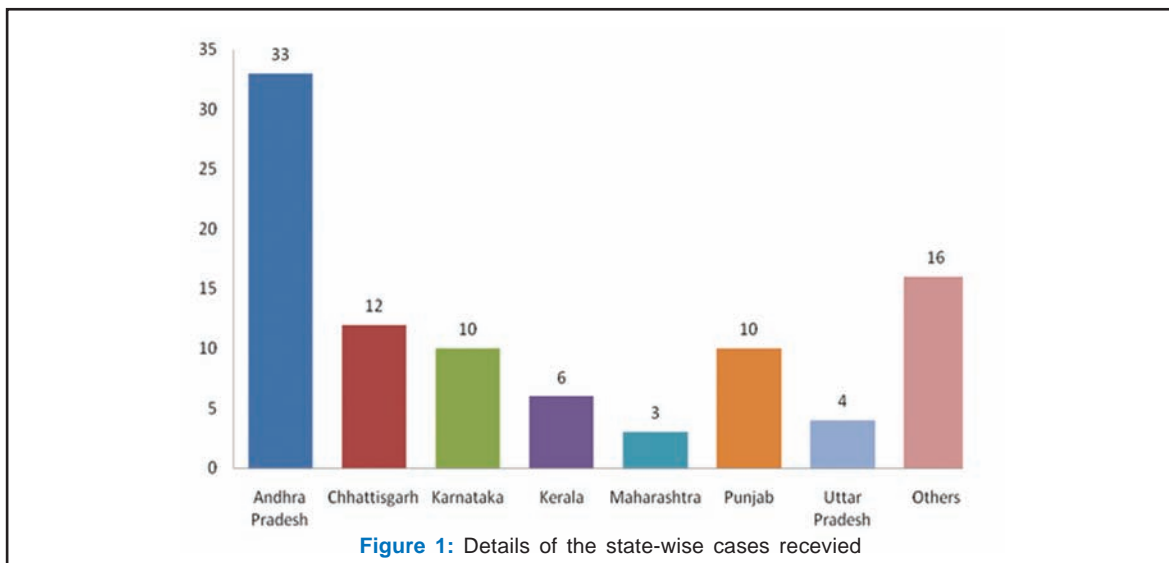

relationship (kidney transplantation). Seventeen States and Union Territories of India have availed DNA fingerprinting services of CDFD during this period. Andhra Pradesh forwarded the highest number of cases (33) followed by Chhattisgarh (12), Karnataka (10), Punjab (10), Kerala (6), Maharashtra (3), Uttar Pradesh (4), Bihar (3), Delhi

Publications

1. Gunnarsdóttir ED, Nandineni MR, Li M, Myles S, Gil D, Pakendorf B and Stoneking M (2011). Larger mtDNA than Y-chromosome differences between matrilineal and patrilineal groups from Sumatra. *Nature Communications* 2: 228.

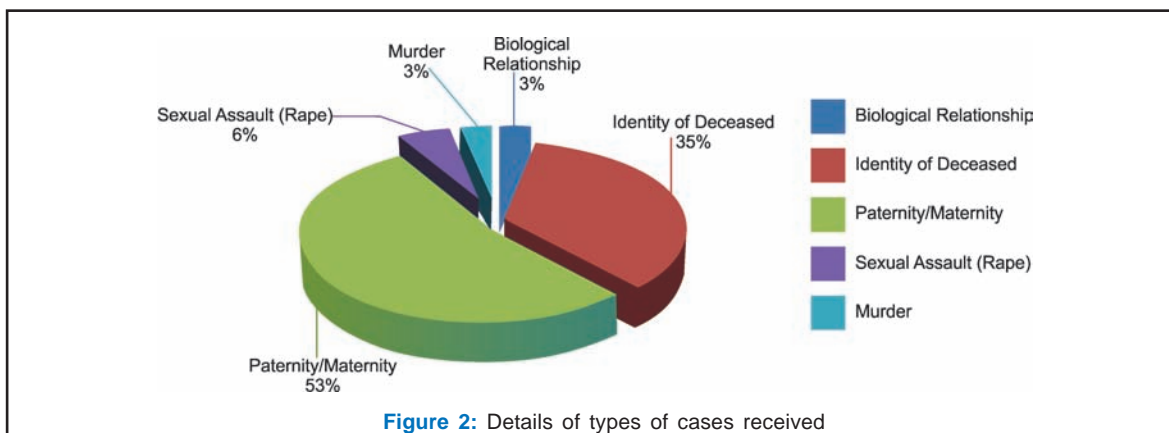

(3), Jammu & Kashmir (2), Jharkhand (1), Madhya Pradesh (1), Orissa (1), Puducherry (1), Tamil Nadu (1) and Uttarakhand (1) (Figure 1).

During this reporting period, an amount of ₹ 15,91,074/- (Rupees fifteen lakhs ninety one thousand and seventy four only) has been received towards DNA fingerprinting analysis charges, which is inclusive of service charges, as levied by Govt. of India.

The cases involving paternity (53%) and identification of the deceased (35%), constituted the bulk of the cases received (Figure 2).

2. Reich D, Patterson N, Kircher M, Delfin F, Nandineni MR, Pugach I, Ko AMS, Ko YC, Jinam TA, Phipps ME, Saitou N, Wollstein A, Kayser M, Paabo S and Stoneking M (2011). Denisova admixture and the first modern human dispersals into Southeast Asia and Oceania. *American Journal of Human Genetics* 89: 516-528.
3. Ranganath P, Sharma V, Danda S, Nandineni MR and Dalal A. Report of novel mutations in the lysosomal sialidase (NEU1) gene in Indian cases of sialidosis. *Indian Journal of Medical Research* (In press).

DIAGNOSTICS DIVISION

Principal Investigator	Ashwin Dalal	Staff Scientist
Adjunct Faculty	Prajnya Ranganath	NIMS, Hyderabad
PhD Students	Anusha Uttarilli Anjana Kar	Senior Research Fellow Junior Research Fellow (Since Feb. 2012)
Other Members	P Rajitha GR Savithri Angalena R Pooja KP Usha Rani Dutta Jamal Md Nurul Jain Sri Lakshmi Bhavani G Sai Shruthi C Vijay Kumar Pidugu Seetalakshmi S C Krishna Prasad R Sudheer Kumar	Technical Officer III Technical Officer II Technical Officer II Technical Officer II (Till Jan. 2012) Technical Officer I Technical Officer I Research Assistant Research Assistant Project Assistant Project Assistant (Since Jan. 2012) Technician II Technician II

Objectives

1. To conduct genetic evaluation for patients / families with genetic disorders;
2. To develop new methods and assays for genetic analysis and engage in research on chromosomal and single gene disorders;
3. To act as national referral center for analysis and quality control of genetic tests for few genetic diseases;
4. To impart training in genetic evaluation of patients with genetic disorders.

I. Details of the services provided in the current reporting year (April 1, 2011 – March 31, 2012)

Clinical Genetics

A total of 2149 patients were presented for genetic evaluation and counseling, during the year 2011-12. These consisted of patients with chromosomal disorders, monogenic disorders, mental retardation, congenital malformations, inborn errors of metabolism, and familial disorders.

The Medical Genetics Unit, established at Nizam's Institute of Medical Sciences, Hyderabad is running successfully and a Department of Medical Genetics has been formally created with appointment of two Assistant Professors. A total of 809 patients were examined and counseled in the unit during 2011-12.

Genetic investigations done during 2011-12

Investigation	Total cases	Positives
Cytogenetics	979	111 (11.3%)
Proband	867	107 (12.3%)
Prenatal	112	4 (3.6%)
Molecular Genetics	770	326 (42.3%)
Proband	714	317 (44.4%)
Prenatal	56	9 (16%)
Biochemical Genetics	857	197 (23%)
Proband	847	191 (22.5%)
Prenatal	10	6 (60%)

Cytogenetics

Disease	Abnormality	No. of cases
Down Syndrome	Trisomy 21	38
	46,XY,rob(21;21) +21	3
	46,SC,rob(21;21) +21	1
	46,XX,t(13;21)+21	2
	46,XX,t(15;21)+21	1
Turner Syndrome	Monosomy X (45,X)	12
	iso X,(46,X,i(X))	3
	Mosaic 45,X/ 46,X,i(X)	3
	Mosaic 45,X/ 46,X, i(X)/46XX	1
	Mosaic 46,X r(X)/46XX	1
	Mosaic 45,X/46XY	2
Klinefelter Syndrome	47,XXY	3
	48,XXX	1
	48,XXYY	1
	49,XXXXY	1
Sex Reversal	Phenotypic female with 46,XY	2

Fluorescence *in situ* Hybridization (FISH)

Disease/translocation	No. of cases	No. of positives
Prader-Willi Syndrome	6	1
Di-George Syndrome	6	1
Williams-Beuren	3	2
46,X,t(Y;15)	1	1
46,XX,inv(1)	1	1
Mosaic Turner Syndrome	2	1
45,XX,dic(14;19)(p11.2;p13.3)/46,XX	1	1

Quantitative Fluorescent PCR (QF-PCR)

QF-PCR kit	No. of cases	No. of positives
Prenatal QF-PCR	23	0
MLPA kit(P064) MR-1	12	1 (PWS)

Structural chromosomal abnormalities

Inversions	
46,XY,inv(9)	1
46,SC,inv(9)	1
46,XY,inv(Y)	2
46,XX,inv(12)(p12q14)	1
Duplications	
46,XY,der(15)(p12)	1
Deletions	
46,XY,del(5)(p)	1
46,XX,del(9)(p22)	1
Translocations	
46,XX,t(13;14)/46,XX	1
46,X,t(X;4)(q27;p16)	1
45,XX,dic(14;19)(p11.2;p13.3)/46,XX	1
46,XY,t(3;15)(q34;q13)	1
46,XX,t(8;20)(p12;q13.3)	1
46,XX,t(2;16)(p23;q24)	1
46,XX,t(2;16)(p23;q24)mat	1
46,XY,t(11;20)(q14.3;q13.3)	1
46,XX,t(4;7)(p12;p12)	1
46,XX,t(3;5;7;13)(q26;q3;p15;q34)	1
46,XX,der(7;13)t(3;5;7;13)(q26;q33;p15;p34)	1
46,XX,t(4;13)(q28;q34)	1
46,XY,t(1;18)	1
46,SC,t(3;7)(q26.2;q36)	1
47,XX+marker/46,XX	1
46,XY,r(18)/45,XY-18	1
Polymorphic variants	
46,XX,9qh+	1
46,XY,14p+	1
46,XY,14p+	1
46,XY,15p+	4
46,XX,15p+	5
Total	36

Biochemical Genetics

Disease/Test	Positives
Urine Metabolic Screening tests (335)	66
Amino acid disorders (N=160)	20
Maple syrup urine disease	3
Non Ketotic Hyperglycinemia	3
Hyperornithinemia	3
Tyrosinemia	4
Citrullinemia	1
Argininemia	1
Phenylketonuria	5
Lysosomal storage disorders (n=362)	105
Hurler syndrome (17)	2
Hunter syndrome (23)	11
Sanfilippo B (7)	0
Morquio A disease (17)	11
Arylsulphatase B (10)	5
Sly disease (19)	0
GM1-Gangliosidosis (58)	9
Galactosialidosis (1)	1
Gaucher disease (39)	12
Krabbe disease (22)	5
Pompe disease (3)	1
Neuraminidase (1)	0
Nieman Pick disease (39)	14
Mucopolidosis (5)	5
Metachromatic Leukody strophy (49)	11
Fabry's disease (4)	3
Mannosidase (2)	0
Hexosaminidase A/B (46)	
Tay Sachs disease	7
Sandhoff disease	2
Prenatal diagnosis (10)	6
Tay Sach disease (1)	1
Sandhoff 's disease (1)	1
Metachromatic Leukody strophy (4)	2
Gaucher's disease (1)	1
Hunter (1)	0
Pompe's (1)	1
Sly disease (1)	0

Molecular Genetics

Disorders	Cases	Positive	Negative		
DMD/BMD	195	135	60		
DMD Carrier Analysis	21	03	18		
Spinal Muscular Atrophy	95	57	38		
SMA Carrier Analysis	27	18	09		
		Normal	Homozygous	Heterozygous	Compound Heterozygous
β-thalassemia/Sickle cell	116	24	32	44	16
Factor V Leiden	45	43	01	01	-
Factor II mutation	22	22	-	-	-
Cystic Fibrosis	52	44	03	05	-
Triplet Repeat Disorders		Positive	Negative		
Friedreichs Ataxia	47	14	33		
Myotonic Dystrophy	16	08	08		
Huntington Disease	25	16	09		
SCA Panel (1,2,3,6 & 7)	53	14	39		
Prenatal Diagnosis					
DMD	6	-	6		
Spinal Muscular Atrophy	15	02	13		
		Normal	Homozygous	Heterozygous	Compound Heterozygous
β-thalassemia	35	05	06	22	01

(II) Diagnostics Research

Project I: Cloning, characterization and analysis of chromosomal rearrangements in human genetic disorders

Summary of work done until the beginning of this reporting year (Upto March 31, 2011)

Structural rearrangements alter the genome architecture and may result in human disease phenotypes. The patients with translocations and inversions often have breakpoints located within the disease gene, or very close to it. In order to identify the disease gene, breakpoints can be characterized and if any gene is disrupted by rearrangement then it is considered as a candidate gene. Cloning their breakpoint can provide the quickest route to identifying the disease gene. This project deals with the molecular characterization of chromosomal breakpoints associated with specific clinical phenotypes. We have identified two cases of novel balanced translocations associated with disease and presently are working with the first case i.e., a girl with delayed milestones and seizures with a karyotype of 46,XX,t(X;20)(q13;p13)

(Figure 1A).

In order to confirm the breakpoint regions, FISH (Fluorescence-*in situ*-hybridization) experiments were performed. Further characterization was achieved by FISH with BACs (Bacterial Artificial Chromosome) which were selected by *in silico* analysis using the human genome databases. BAC clones were first labelled by nick translation and the probes thus made were used for further FISH experiments.

(a) Delineation of the breakpoint region on Xq13 region

Initially 8 BAC clones were selected from Xq13 region, out of which 6 showed signals on normal X and derived 20 whereas 2 showed signals on normal X and derived X. Hence the breakpoint region was narrowed down to 4Mb between the two clones RP11-804E20 and RP11-770E18.

(b) Delineation of the breakpoint region on 20p13 region

Similarly among the 2 clones on the 20p13 region; RP11-706G18 showed signals on normal 20 and

on derived 20 whereas RP11-666H23 showed signals on normal 20 and derived X, thus anchoring the breakpoint region between these two clones to a distance of 2.3Mb. A contig of 14 clones on Xq and 6 clones on 20p region were identified covering the breakpoint spanning region.

Details of progress made in the current reporting year (April 1, 2011 – March 31, 2012)

Molecular characterization of t(X;20) breakpoints

1. Delineation of the breakpoint region using BACs

Seventy BAC clones were selected tentatively depending on the position of the chromosomal breakpoints. 44 BAC clones from the Xq region and 26 clones from the 20p region were selected. FISH was performed with all the clones. On Xq region (Figure 1C), FISH with BAC clone RP11-804E20 showed signals on normal X and derived X

whereas RP11-772H19 showed signals on normal X and derived 20, thus narrowing down the breakpoint region to 237 kb. A contig of 2 clones were identified covering this region for the identification of split signals. On the 20p region FISH was performed with 26 BAC clones (Figure 1D). FISH with BAC clone RP11-720M07 showing signals on normal 20 and derived 20 and RP11-627A23 showing signals on normal 20 and derived X narrowed down the breakpoint region to 203kb region. A contig of 3 BAC clones covering this region were identified and the work is underway.

2. HUMARA assay

To check the skewing of X chromosome we have done methylation specific PCR for the human androgen-receptor gene (HUMARA) located on Xq11-12 region. The results showed that there is Skewed X-inactivation in our patient (Figure 1B) which is expected whenever the X chromosome is involved in a translocation with any other autosome.

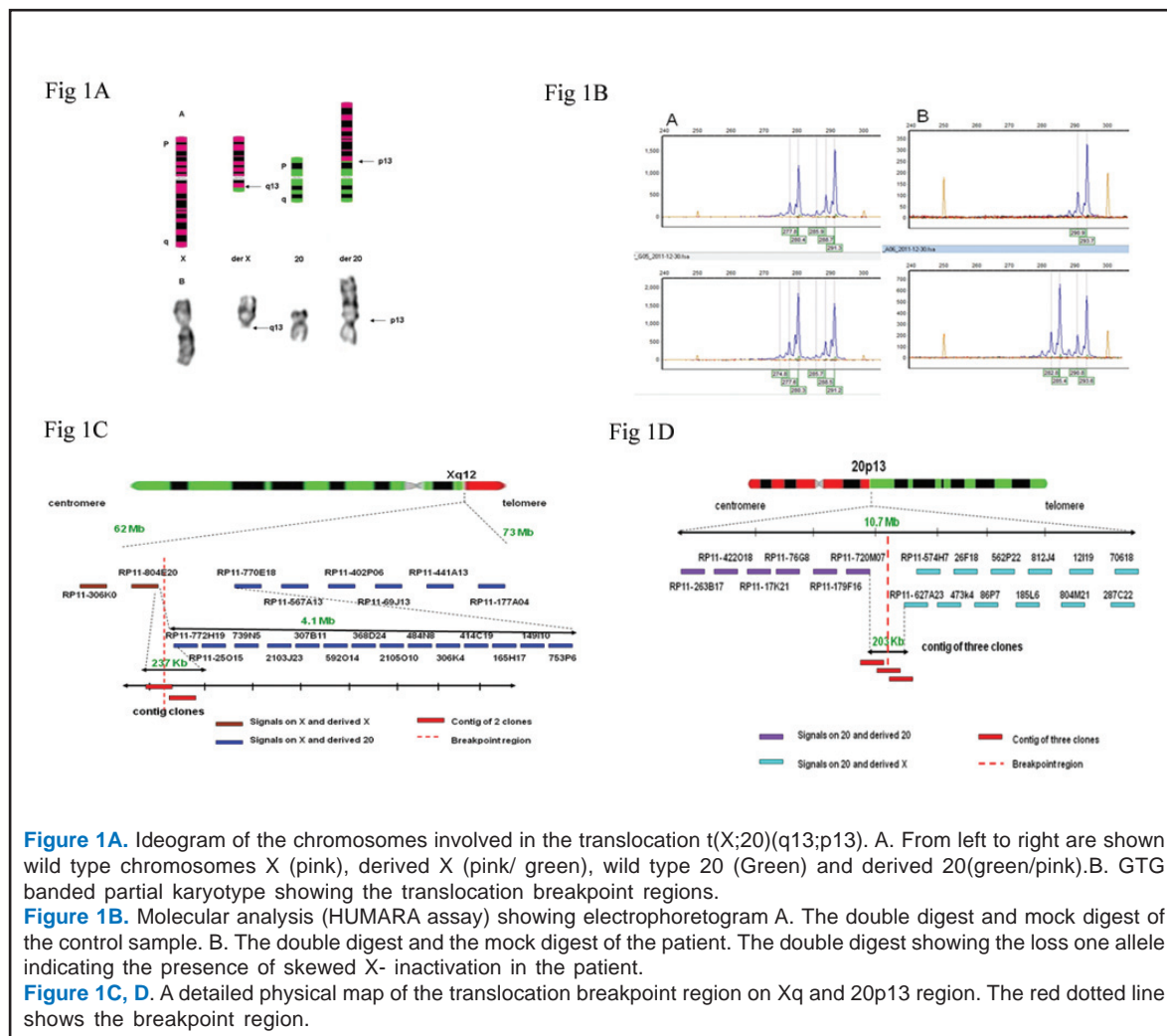

3. Array comparative genomic hybridization analysis

Human CytoSNP-12 Bead chip (Illumina, San Diego, CA) spanning the entire genome-wide tag SNPs and additional markers targeting all regions of known cytogenetic importance was used for this assay. The array CGH studies confirmed that this translocation is not associated with any gains or losses at the breakpoints and elsewhere in the genome.

Project II: Clinical, biochemical and molecular analysis of common lysosomal storage disorders

Summary of work done until the beginning of this reporting year (Upto March 31, 2011)

Lysosomal storage disorders are a heterogeneous group of disorders associated with specific lysosomal enzyme deficiency. The diagnosis in most of these disorders is based on enzyme assay. There is a large amount of overlap in enzyme levels among carriers and normal people; hence it is very difficult to detect carriers by enzyme assay. Mutation detection is helpful for carrier detection and accurate prenatal diagnosis. Our study aims to characterize the clinical features, biochemical

parameters and molecular defects in common lysosomal storage disorders.

We focused mainly on 3 lysosomal storage disorders in the last reporting year *viz.* Niemann-Pick Disease, Metachromatic Leukodystrophy and Sialidosis.

Details of progress made in the current reporting year (April 1, 2011 – March 31, 2012)

We are continuing the work in Metachromatic Leukodystrophy and Niemann-pick disease. During current reporting year, we designed primers and standardized the PCR conditions for more disorders *viz.*, Aspartylglucosaminuria, Galactosialidosis, Hunter Syndrome and Maroteaux-Lamy syndrome.

For mutation analysis, primers were designed using PRIMER 3 Software and PCR was carried out with primers encompassing the entire exons and the flanking intronic regions of the corresponding gene in all the patients. Bidirectional sequencing was carried out on all the purified PCR products by capillary electrophoresis on ABI 3130 automated genetic analyzer (Applied Biosystems, Foster City, CA).

Type of LSD	Total Mutations	Novel	Known
Niemann-Pick Disease	11	7	4
Metachromatic Leukodystrophy	6	1	5
Sialidosis	3	3	0

Niemann-Pick Disease

Acid sphingomyelinase activity was measured in the patient leucocytes using the substrate 2-N-(hexadecanoyl)-amino-4-nitrophenyl-phosphorylcholine. A total of eleven mutations were observed in ten patients (Table 1) and four novel mutations in nine carriers. Out of these, three patients were compound heterozygotes. The enzyme levels were severely decreased in all the patients with the observed mutations.

Metachromatic Leukodystrophy

The Arylsulfatase A enzyme activity in patients was measured in the leucocytes using the substrate *p*-Nitrocatechol. A total of eight mutations were observed in eight patients (Table 2) and three mutations in the four carriers. Of these, L251fs is an insertion c.752-753insT and 459+1G>A is a splice site mutation. The enzyme levels were severely decreased in all the patients with the observed mutations.

Type of LSD	Total Mutations	Novel	Known
Niemann-Pick Disease	15	14	1
Metachromatic Leukodystrophy	11	6	5
Hunter Syndrome	2	0	2
Maroteaux-Lamy Syndrome	14	12	2

S. No.	Exon	Mutation
1	Exon 1/ Exon 6	c.193delT/I520L
2	Exon 2/ Exon 2	G319R/G319R
3	Exon 2/ Exon 6	C.564_565insC/S510F
4	Exon 3/ Exon 6	M384V/R542X
5	Exon 6/ Exon 6	c.1815delC/c.1815delC
6	Exon 6/ Exon 6	Y519C/Y519C
7	Exon 6/ Exon 6	R542X/ R542X
8	Exon 6/ Exon 6	R542X/ R542X
9	Exon 6/ Exon 6	R542X/ R542X
10	Exon 4/Exon 4	N549K/N549K

Table 1. Mutations in patients of NPD

Patient	No. of the Exon	Mutation
1	Exon 2	Q139K
2	Intron 2	459+1G>A
3	Exon 3	P180Q
4	Exon 4	G245R
5	Exon 4	L251fs
6	Exon 4	T274M
7	Exon 5	R299W
8	Exon 5	R311X

Table 2. Mutations in patients of MLD

Hunter Syndrome (Mucopolysaccharidosis type II - MPS II)

The Iduronate-2-sulphatase (IDS) enzyme activity is determined in patients by using the substrate 4-Methyl umbelliferone derivative. The enzyme levels were severely decreased in all the patients with the observed mutations. Mutations identified are shown in Table 3.

No. of the Patient	No. of the Exon	Mutation
Patient 1	Exon 3	G140R
Patient 2	Exon 3	G140R
Patient 3	Exon 3	A85T

Table 3. Mutations in MPS II disorder

Maroteaux-Lamy Syndrome (Mucopolysaccharidosis type VI - MPS I)

N-Acetyl galactosamine-4-sulphatase (ARSB) activity was measured in the patient leucocytes using the substrate 4-nitrocatechol sulphate. A total of 14 mutations were observed in twenty one

No. of the Patient	No. of the Exon	Mutation
Patient 1&2	Exon 1	L98R
Patient 3 &4	Exon 1	D53N
Patient 5	Exon 2	c.del 496 T
Patient 6	Exon 8	W450C
Patient 7	Exon 8	W450L
Patient 8	Exon 4	A237D
Patient 9	Exon 6	c.del1208 C
Patient 10	Exon 7/Exon 8	P445L/W450C
Patient 11	Exon 6	H393R
Patient 12	Exon 2	R160Q
Patient 13&14	Exon 8	c.1577 del C
Patient 15	Exon 6	E390K
Patient 16	Exon 1	c.208^215 del CCGCACCT
Patient 17,18, 19&20	Exon 5	L321P
Patient 21	Exon 5	V376E

Table 4. Mutations in patients of MPS VI disorder

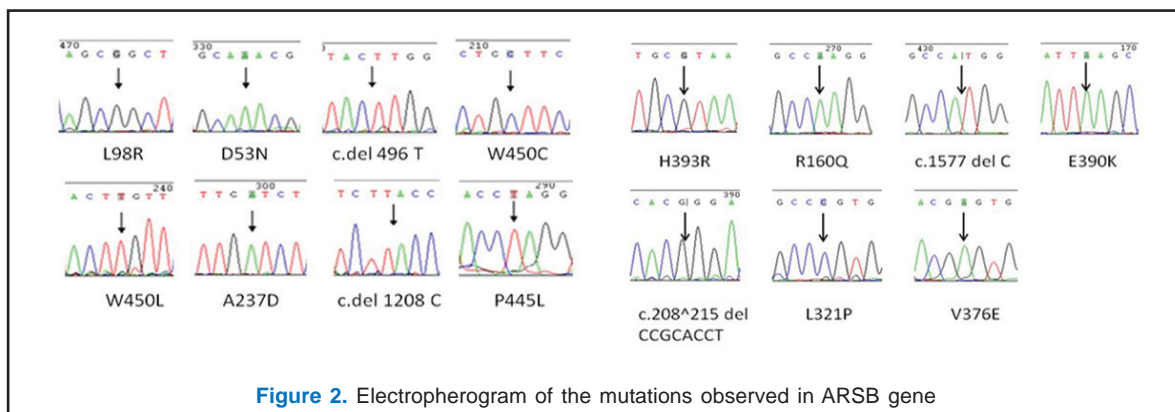

Figure 2. Electropherogram of the mutations observed in ARSB gene

patients, out of which the mutations L98R, D53N, L321P and c.1577 del C were recurrent in more than one patient (Figure 2) (Table 4). The enzyme levels were severely decreased in all the patients with correspondence to the observed mutations.

Publications

1. Dutta UR, Rajitha P, Kumar PV and Dalal A (2011). Cytogenetic abnormalities in 1162 couples with recurrent miscarriages in southern region of India: Report and review. **Journal of Assisted Reproduction and Genetics** 28: 145-149.
2. Ponnala R and Dalal A (2011). Partial monosomy 7q. **Indian Pediatrics** 48: 399-401.
3. Dutta UR, Pidugu VK, Goud V and Dalal AB (2012). Mosaic Down syndrome with a marker: Molecular cytogenetic characterization of the marker chromosome. **Gene** 495:199-204.
4. Kumar R, Panigrahi I, Dalal A and Agarwal S (2012). Sickle cell anemia - Molecular diagnosis and prenatal counseling: SGPGI experience. **Indian Journal of Pediatrics** 79: 68-74.
5. Angalena R, Aggarwal S, Phadke SR and Dalal A. Compound heterozygote condition in beta thalassemia major due to a novel single nucleotide deletion (-T) at codon 69 in association with IVS 1-5 (G>C) mutation. **International Journal of Laboratory Hematology** (In press).
6. Bashyam MD, Chaudhary AK, Reddy EC, Reddy V, Acharya V, Nagarajaram HA, Devi ARR, Bashyam L, Dalal AB, Gupta N, Kabra M, Agarwal M, Phadke SR, Tainwala R, Kumar R and Hariharan SV (2012). A founder ectodysplasin A receptor (EDAR) mutation results in a high frequency of the autosomal recessive form of hypohidrotic ectodermal dysplasia in India. **British Journal of Dermatology** (In press).
7. Padma Priya T and Dalal AB. Tuberous sclerosis: Diagnosis and prenatal diagnosis by MLPA. **Indian Journal of Pediatrics** (In press).
8. Patil SJ, Ponnala R, Shah S and Dalal A. Mosaic Trisomy 9 presenting with congenital heart disease, facial dysmorphism and pigmentary skin lesions: Intricate issues of genetic counseling. **Indian Journal of Pediatrics** (In press).
9. Ponnala R, Ranganath P, Dutta UR, Pidugu VK and Dalal AB. Phenotypic and molecular characterization of partial trisomy 2q resulting from insertion-duplication in chromosome 18q: A case report and review of literature. **Cytogenetic and Genome Research** (In press).
10. Ranganath P, Sharma V, Danda S, Nandineni MR and Dalal A. Report of novel mutations in the lysosomal sialidase (NEU1) gene in Indian cases of sialidosis. **Indian Journal of Medical Research** (In press).
11. Verma PK, Dalal A, Mittal B and Phadke SR. Utility of MLPA in mutation analysis and carrier detection for Duchenne muscular dystrophy. **Indian Journal of Human Genetics** (In press).
12. Verma PK, Ranganath P, Dalal A and Phadke SR. Spectrum of lysosomal storage disorders at medical genetics center in North India. **Indian Pediatrics** (In press).

Other Publications

1. Dalal A (2011). Annual review of genomics and human genetics, 2010. (Book Review) **Current Science** 100: 933-934.
2. Dalal A (2011). Genetic tests. **API Textbook of Medicine**, 9th Edition, Pg. 21-25. Editor-in-Chief: Munjal YP. Jaypee Brothers Medical Publications.
3. Ranganath P and Dalal A (2012). Annual review of genomics and human genetics, 2011. (Book Review) **Current Science** 102: 923-924.

शोध
Research

LABORATORY OF MOLECULAR GENETICS

Centre of Excellence (CoE) for Genetics and Genomics of Silkmooths

Principal Investigators	J Nagaraju	Staff Scientist
	KP Arun Kumar	Staff Scientist
PhD Students	Asha Minz	Senior Research Fellow
	Chandrapal Singh	Senior Research Fellow
	S Suresh Kumar	Senior Research Fellow
	Deepa Badrinarayan	Senior Research Fellow
	G Gopinath	Senior Research Fellow
	TR Sitalakshmi	Senior Research Fellow (Since Jan. 2012)
	Vandana	Junior Research Fellow
	K Akanksha	Junior Research Fellow
Other Members	Parveen Kumar	Junior Research Fellow (Since Jul. 2011)
	Varsha Srivastava	Staff Scientist
	VV Satyavathi	Technical Officer IV (CoE)
	A Sobhan Babu	Technical Officer II
	M Muthulakshmi	Technical Officer II
	S Annapurna	Technical Officer I (CoE)
	Archana Tomar	Bioinformatician (CoE)
	R Lakshmi Vaishna	Technical Assistant (CoE)
	MJ Reddy	Technical Assistant (CoE)
	Jyoti Singh	Research Associate
	K Adarsh Gupta	Project Assistant
Deepa Narra	Project Assistant (Till Jul. 2011)	
Saikat Chakraborty	Project Junior Research Fellow (Since Aug. 2011)	

Objectives

1. Target validation of microRNAs involved in host-pathogen interaction of silkmooths;
2. Identification and functional characterization of novel genes involved in immune response pathways of silkmooths;
3. Functional characterization of silk genes and sex-determination genes in *Bombyx mori*;
4. Introduction of anti-baculoviral property from transgenic silkworms to commercial silkworm strains followed by field trials;
5. Translation of the genetic and genomic knowledge on Indian wild silkmooths.

The progress made in the projects related to transgenic silkworms, microRNAs and immune response is reported here.

Summary of the work done in the projects mentioned above until the beginning of this reporting year (upto March 31, 2011)

- ❖ We have successfully developed transgenic silkworms of Nistari, a non-diapausing polyvoltine strain resistant to BmNPV virus. The BmNPV resistance has been successfully introgressed to a commercial, bivoltine BmNPV susceptible silkworm strain CSR2 through recurrent backcross strategy.
- ❖ Using *B. mori*, we have discovered many host-encoded miRNAs that have targets in the baculovirus essential transcripts, and many baculovirus-encoded microRNAs that have targets in the host genes involved in immune function.
- ❖ During the last five years, several immune related genes have been characterized in silkmooths.

Details of progress made in the current reporting year (April 1, 2011 - March 31, 2012)

Project 1: Evaluation of the role of baculovirus-encoded microRNAs in baculoviral infection in silkworm

In our previous study, we discovered 4 BmNPV-encoded miRNAs. *In silico* prediction of the host targets had shown Ran (Ras-related nuclear protein) as one of the potential targets of bmnvp-miR-1 (Singh *et al.* 2010, Virology 407:120-128). Ran-GTP acts as a cofactor for Exportin-5, which governs the nuclear export of pre-miRNAs from the nucleus to the cytoplasm. Exportin-5 binds to pre-miRNA in the presence of Ran-GTP, whereas, hydrolysis of Ran-GTP to Ran-GDP is essential for the release of pre-miRNA in the cytoplasm. We carried out functional analysis of bmnvp-miR-1 to show that it acts as a suppressor of Ran in both cell culture and *in vivo* in *B. mori* (Figure 1). We

found that bmnvp-miR-1 significantly represses the expression of Ran both at transcript and protein levels, resulting in the impairment of Ran-GTP-mediated small RNA transport in the host (Figure 2). Consistent with this result, blocking of bmnvp-miR-1 by specific LNA resulted in higher *Ran* transcript level and decrease in virus titre in BmNPV infected larvae. Further, we assessed the virus load by blocking one of the host miRNAs, bmo-miR-8 which has target in the essential gene of the baculovirus (*ie1*), which was suppressed by bmnvp-miR-1 and *Ran* dsRNA, by specific LNA. The virus load was dramatically increased upon inhibition of this host miRNA. Our results provide convincing evidence that BmNPV suppresses the small RNA-mediated host defense to successfully proliferate in the host cells by employing bmnvp-miR-1. The present study thus provides an insight into yet another layer of complex host-viral interactions mediated by a virus-encoded miRNA.

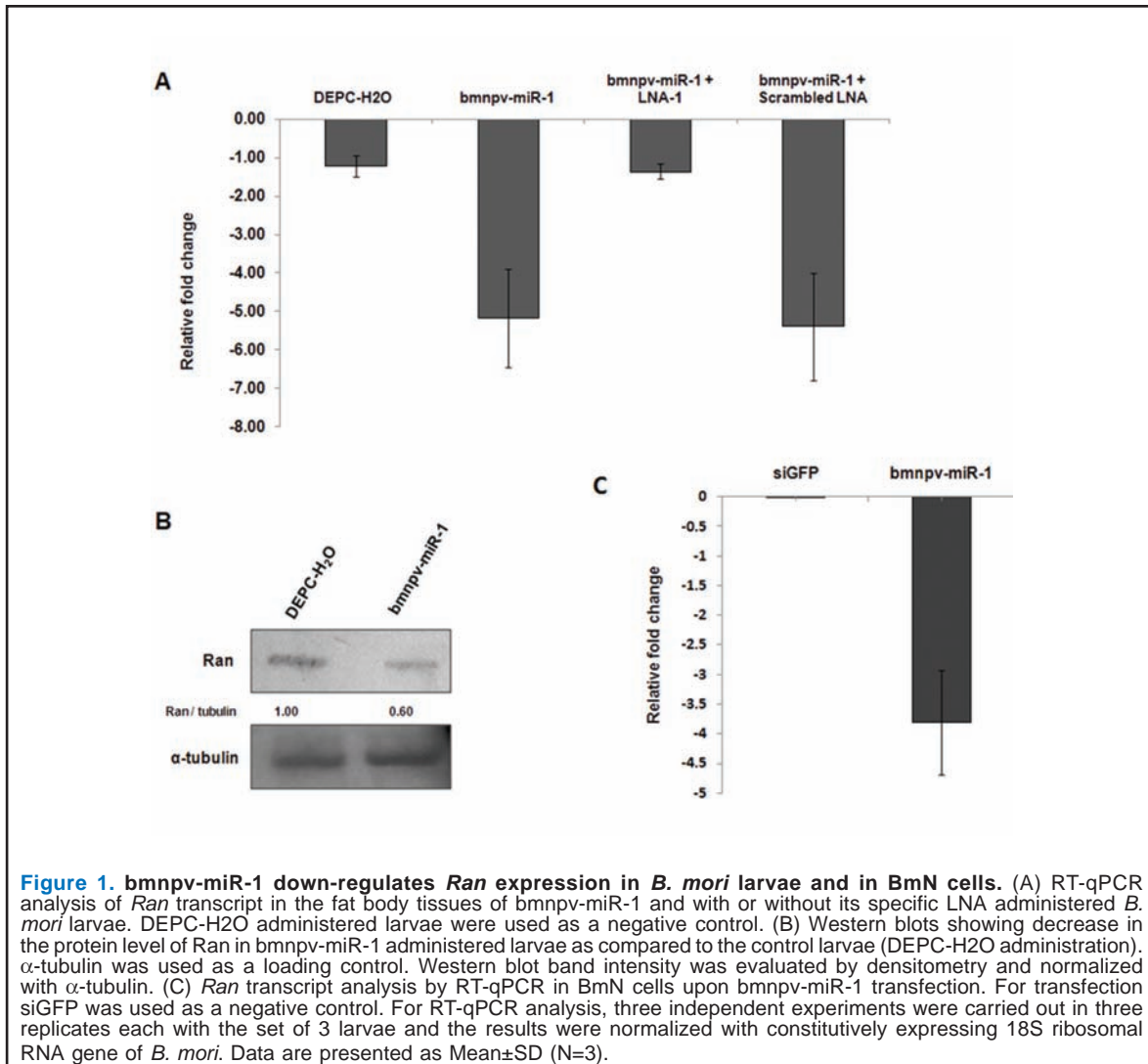

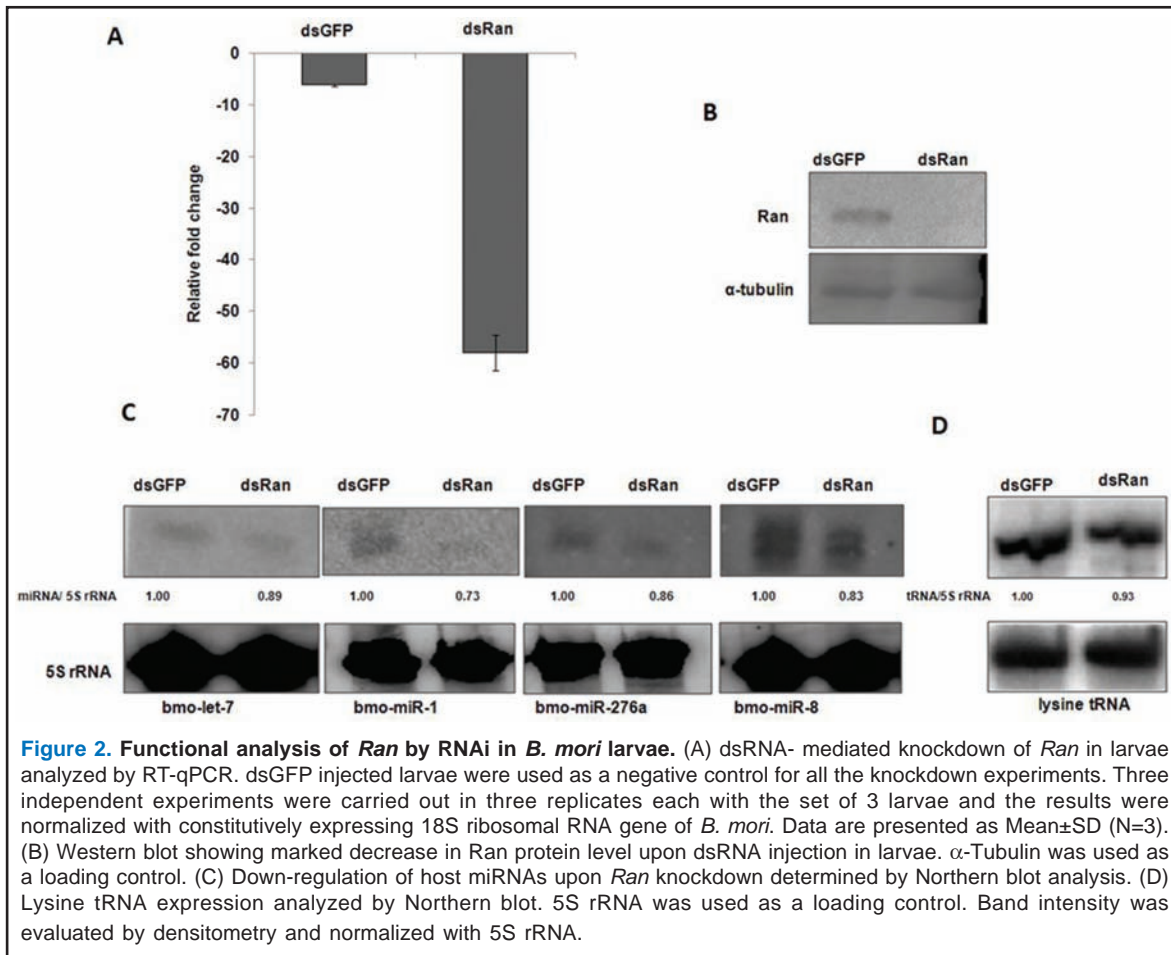

Project 2: Characterization of immune response genes in silkmoths

Among immune genes, we studied the regulation of a *Rel* gene *dorsal*. The Rel family proteins are important regulatory proteins that function as DNA-binding transcription factors resulting in turning on (activation) and off (repression) of genes upon infection. Dorsal (DI), a morphogen, activates as well as represses target genes during embryonic dorso-ventral patterning in *Drosophila*. DI, like other proteins of the Rel family, binds to a 'loosely' conserved DNA sequence (GGRRYYCCC) known as κ B-motif. It is not known how DI decides which genes to activate and which to repress. Using genomic, biophysical and biochemical approaches, we demonstrated that the underlying principle of this functional specificity lies in the 'sequence-encoded structure' of the κ B DNA. We investigated 'nucleotide signatures' in DI-binding motifs with respect to their activator / repressor functions. Figure 3 shows sequence bias in the composition of the activator and repressor κ B-motifs. We found that the ability of DI to activate or repress target

genes depends on the geometry of κ B-DNA which in turn depends on its sequence. Dorsal-binding motifs exist in distinct activator and repressor conformations. Molecular dynamics of DNA-Dorsal complexes revealed that repressor κ B-motifs typically have A-tract and flexible conformation facilitating interaction with co-repressors (Figure 4). Deformable structure of repressor motifs, is due to changes in the hydrogen bonding in A:T pair in the 'A-tract' core. The sixth nucleotide in the κ B-motif, 'A' (A6) in the repressor motifs and 'T' (T6) in the activator motifs, is critical to confer this functional specificity as A6 \rightarrow T6 mutation transformed flexible repressor conformation into a rigid activator conformation. Hence, we reasoned that 'A-tract κ B' motifs have deformable structure to facilitate context-based interaction of the same DI with different co-repressors in a gene-specific manner as revealed by differences in their DNA geometry. Our findings indicate that the structure of the κ B-DNA backbone is an important factor that determines not only the ability of DI to bind the κ B-motif but also its ability to interact with cofactors.

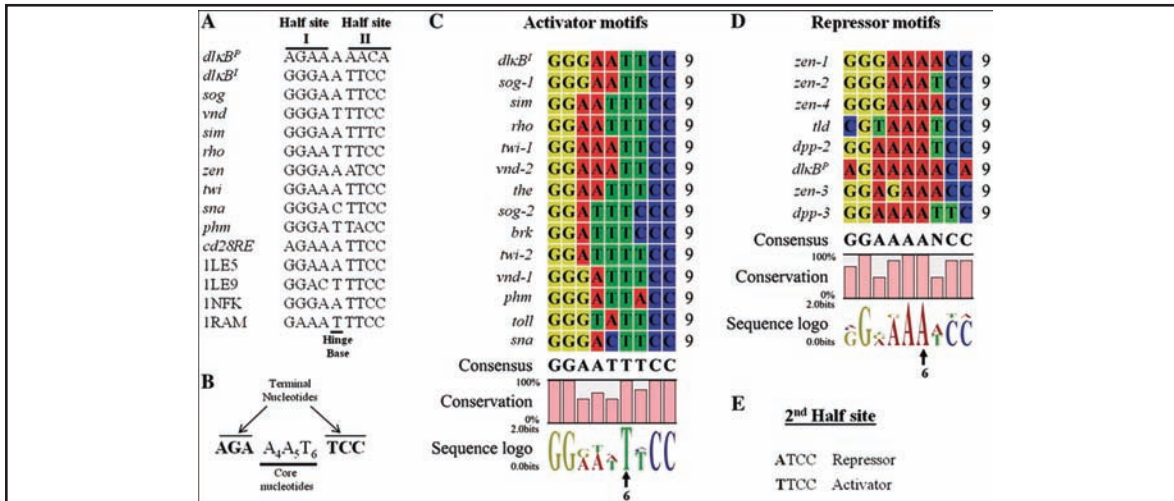

Figure 3. Sequence bias in the composition of the activator and repressor κ B-motifs. (A) The second half-site of the κ B-sequence dyad is more conserved than the first half-site. Hinge nucleotide (underlined) of the dyad is usually A or T. (B) Only the bases at the termini (shown in bold) form protein contacts while the core bases (underlined) usually do not form hydrogen bonds with proteins. (C and D) Repressor motifs have 'A-tract' which is lacking in the activator motifs as revealed by Weblogo consensus. The sixth base in the repressor κ B-motifs is always 'A'. For the repressor motif consensus prediction, the κ B-motifs present in D1 repressor target genes *dpp* and *zen* were taken into consideration, however only one motif in each gene is functional. Thus all functional repressor motifs have A-tract and the sixth base is always 'A'. (E) First half-site consensus is same for both activator and repressor motifs but not the second half site. First base of the second half-site (bold) is A in the repressor motifs and T in the activator motifs.

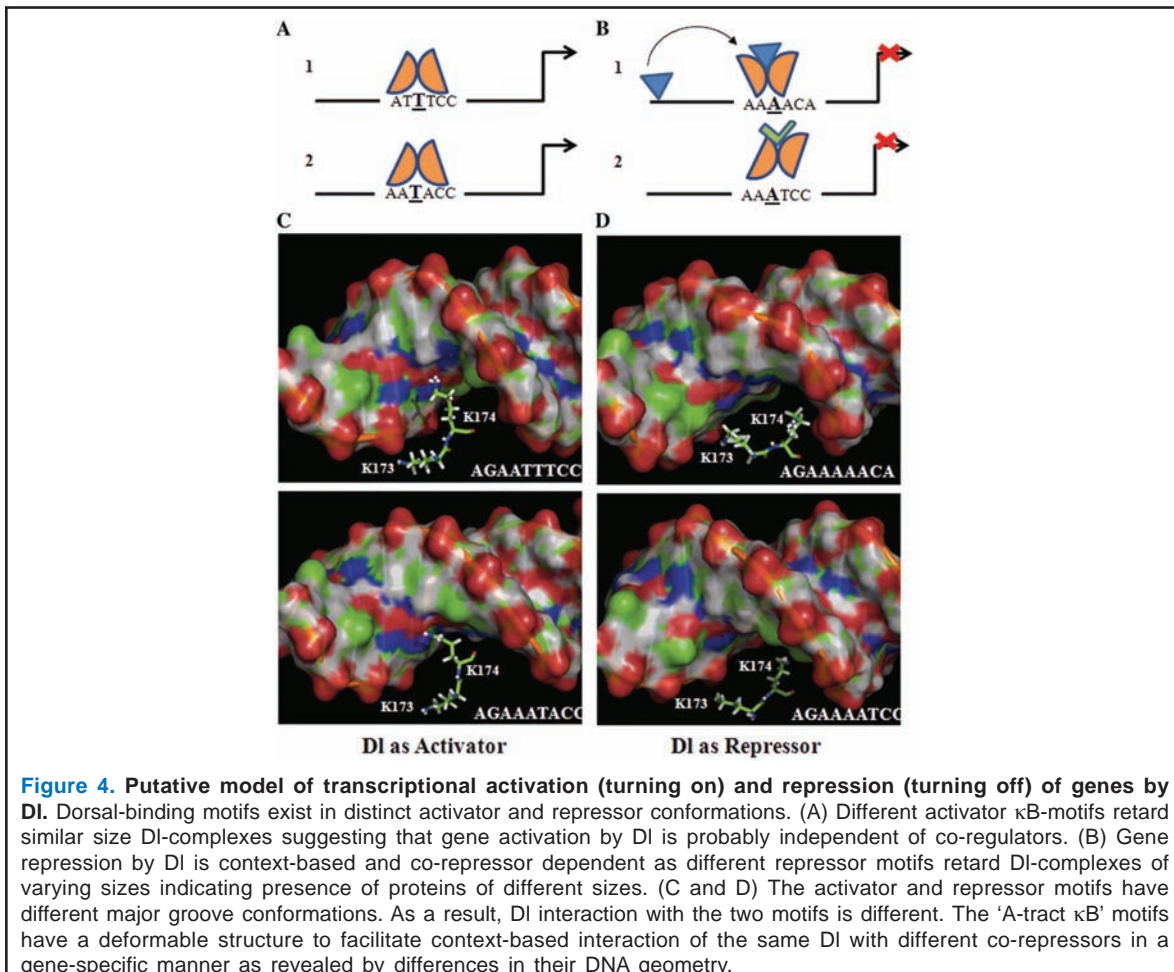

Figure 4. Putative model of transcriptional activation (turning on) and repression (turning off) of genes by DI. Dorsal-binding motifs exist in distinct activator and repressor conformations. (A) Different activator κ B-motifs retard similar size DI-complexes suggesting that gene activation by DI is probably independent of co-regulators. (B) Gene repression by DI is context-based and co-repressor dependent as different repressor motifs retard DI-complexes of varying sizes indicating presence of proteins of different sizes. (C and D) The activator and repressor motifs have different major groove conformations. As a result, DI interaction with the two motifs is different. The 'A-tract κ B' motifs have a deformable structure to facilitate context-based interaction of the same DI with different co-repressors in a gene-specific manner as revealed by differences in their DNA geometry.

Project 3: Limited multilocational field trials of transgenic silkworms

Baculoviral resistance from transgenic silkworms of Nistari (Polyvoltine) strain was successfully introgressed to a commercial, baculovirus susceptible CSR2 (Bivoltine) strain using a recurrent backcross strategy coupled with selection for transgenic markers and microsatellite alleles specific to recurrent parent. The schematic diagram showing introgression of transgenes essential for baculoviral resistance from transgenic Nistari lines to high yielding CSR2 line is given in Figure 5. The resultant backcross lines were screened for survival

rate and silk cocoon quality after feeding baculovirus inclusion bodies *per os* (40,000 OBs/larvae @ 1ml for 100 larvae). The transgenic silkworm lines and the introgressed transgenic lines (BC4F13) are being maintained in the silkworm germplasm and monitored for the transgene stability and unique traits of the strains at APSSRD1, Hindupur. The performance of these lines with regard to survival rate and other silk cocoon characteristics are shown in Figure 6. An application to IBSC/RCGM was submitted for the approval to carryout limited multilocational field trials of transgenic lines for testing the efficacy of transgenes at field level.

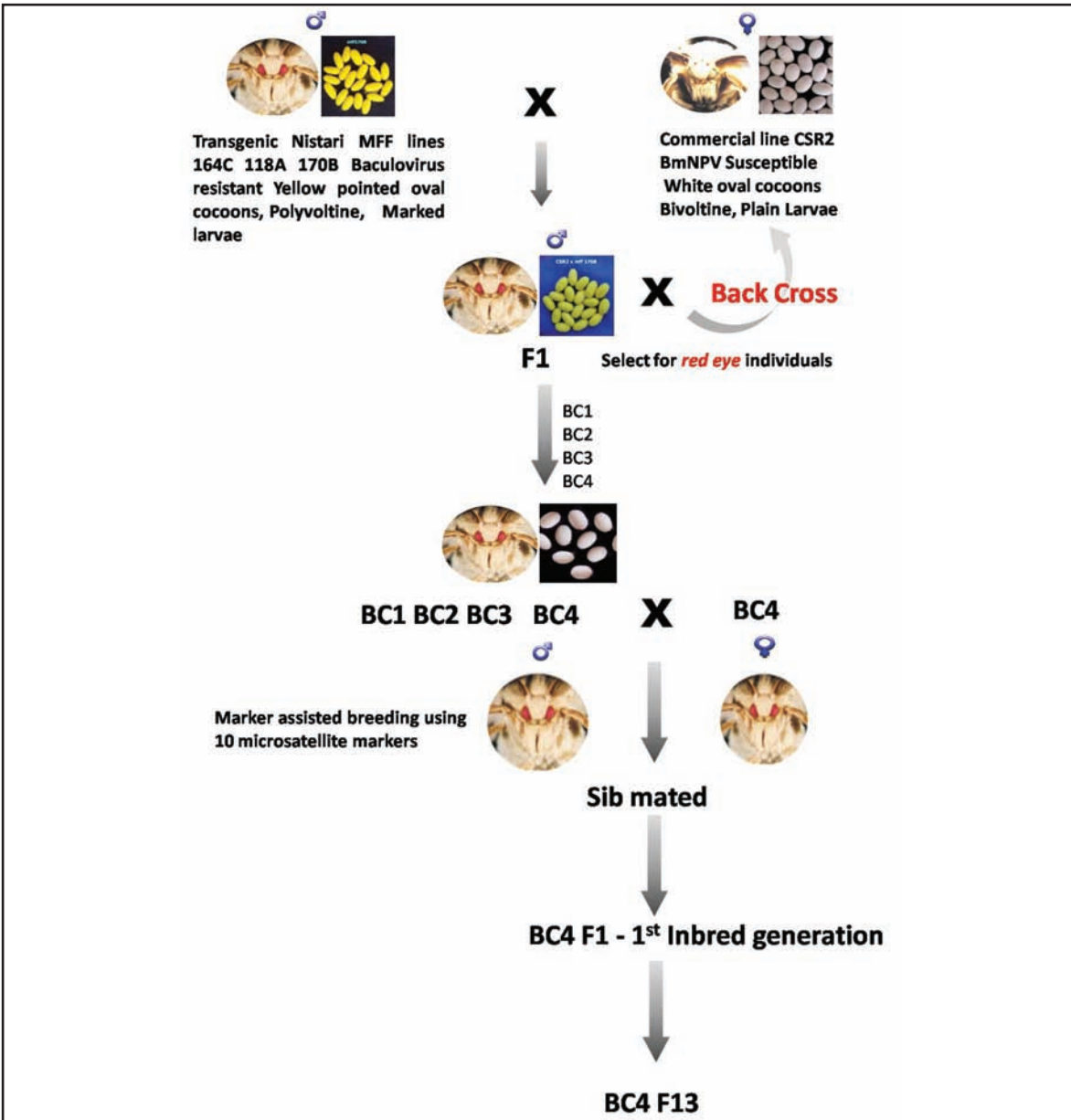
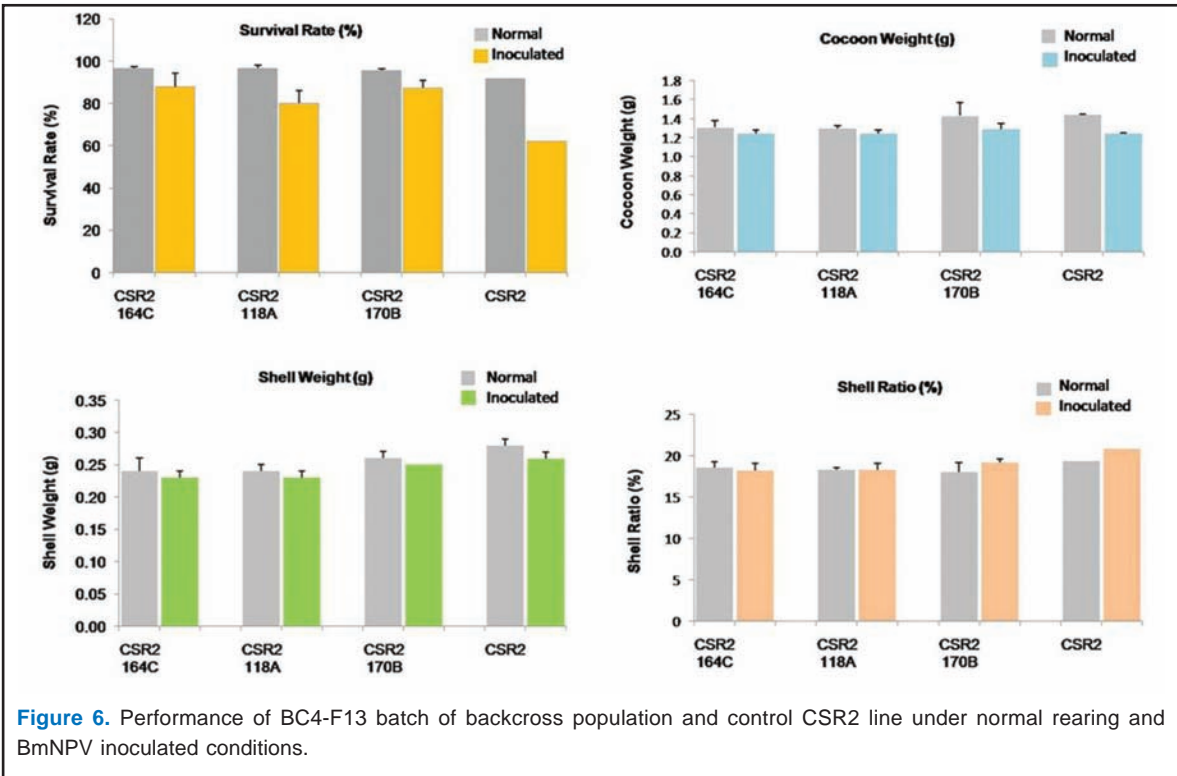

Figure 5. Schematic diagram showing “introgression” of transgene (dsRNA for multiple essential baculoviral genes) from transgenic Nistari lines to high yielding CSR2 line.



APEDA-CDFD CENTRE FOR BASMATI DNA ANALYSIS

Principal Investigator and Consultant	J Nagaraju	Staff Scientist
Other Members	Sabahat Noor Manju Shukla	Technical Officer II Project Assistant

Objectives

1. Testing of purity of Basmati samples received from Export Inspection Council (EIC), Ministry of Commerce, Govt. of India, Basmati rice exporters from India and other countries;
2. Fine mapping and characterization of the candidate genes of grain appearance traits of Basmati rice.

Basmati samples analyzed at APEDA-CDFD Centre in the current reporting year (April 1, 2011 – March 31, 2012)

During the period under report, a total of 160 Basmati samples were analyzed and the number of samples indicating the percentage of adulteration with non-basmati rice is shown in figure below.

Objective

To fine map and characterize the candidate genes of grain appearance traits of Basmati rice in a promising Quantitative Trait Locus (QTL) on Chromosome 5.

Summary of the work done until the beginning of this reporting year (Upto March 31, 2011)

A total of 47 QTLs for 16 different agronomic and quality traits were mapped in an F₂ mapping population of 181 plants, derived from a cross between a traditional Basmati variety Basmati 370 and a semi dwarf variety Jaya. These QTLs were distributed on all chromosomes except 7 and 12. Grain length, grain breadth, length/breadth ratio and chalkiness are important attributes determining the grain appearance quality of Basmati rice. In the present study, two QTL clusters for grain appearance

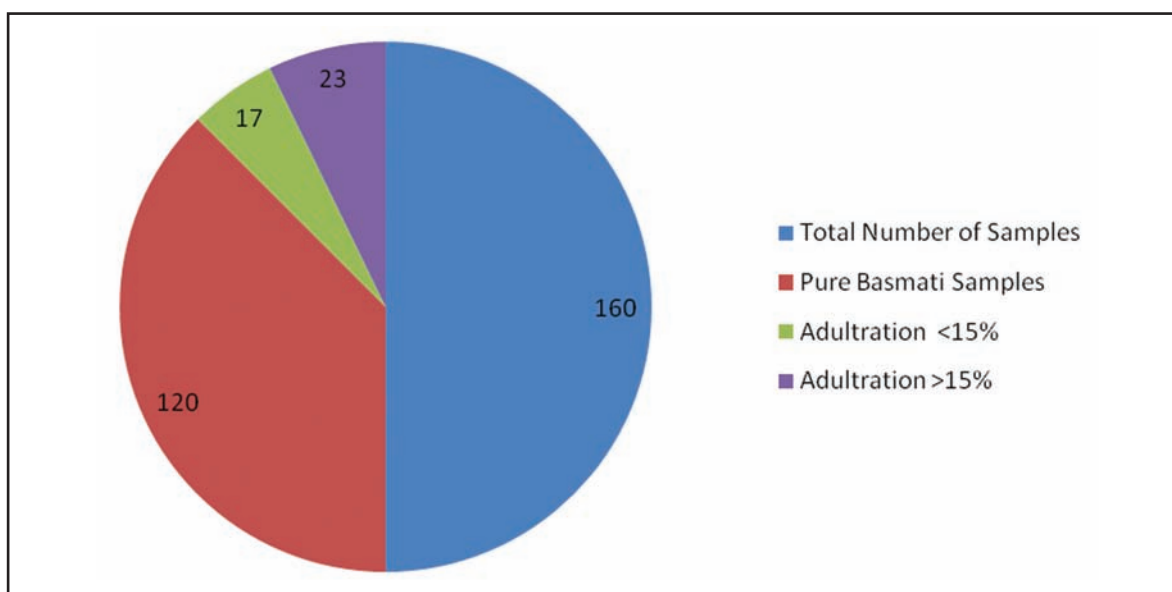

Basmati Rice Genetics and Genomics

Project 1: Fine mapping and association study of candidate genes in a promising region on chromosome 5 controlling grain appearance traits of Basmati rice

traits of Basmati have been identified on two different chromosomes namely Chr 3 and Chr 5. The QTL cluster identified on Chr 5 comprises *qGL5.1*, *qGB5.1*, *qGB5.2*, *qLB5.1*, *qER5.1*, *qER5.2*, and *qCHK5.1* in the marker interval of RM289 and RM18600, while another cluster for

grain breadth and length/breadth ratio was identified on Chr 3 at the marker interval RM16 and RM5864.

Details of progress made in the current reporting year (April 1, 2011 – March 31, 2012)

One of the ultimate goals of genetic mapping of complex traits is to isolate candidate genes at QTL regions. In the present study, one QTL region at marker interval of RM430 and RM18600 on chromosome 5 spanning a physical distance of 327.1kb was chosen for identification of candidate genes as it controls grain breadth, grain length, length/breadth ratio and elongation ratio. Based on the rice genome sequence information, 50 genes are present at this region. Of the 50 genes, two predicted genes, AP2 transcription factor and RING E3 ligase have been reported to be involved in controlling the seed size and weight. Hence, these two genes have been chosen for further studies. Within these two predicted candidate genes, AP2 domain transcription factor was sequenced with both gDNA and cDNA of Basmati 370 and aligned to indica and japonica reference sequences to assess any DNA variation. The sequence results, including the promoter region, revealed 7 Single Nucleotide Polymorphism (SNPs) when compared to indica, but was exactly similar to the japonica sequence. Therefore, none of the SNPs can be considered as functional nucleotide polymorphism (FNP) for the predicted gene. The second predicted gene, RING E3 ligase protein was sequenced with Basmati 370 cDNA and three FNPs were observed when compared to indica sequence. However, there is wrong annotation of current gene in japonica which was referred from different sites viz. Gramene, NCBI, Phytozome and OryGenesDB and confirmed with rice group of MSU, Gramene (Michigan State University). Mapping population of 155 Recombinant Inbred Lines (RILs) at F₆ stage is in progress for confirmation and fine mapping of the grain size QTL already identified in the F₂ population developed by crossing Basmati 370 and Jaya. Our future work plan includes the following:

1. Further narrowing down of targeted QTL region through:
 - a. Association mapping;
 - b. Development of advanced back cross population and/ NILs;
 - c. Prediction of candidate genes and their structural and functional analysis.
2. Other approaches include use of resequencing data to align genomic sequence of QTL region

with the available rice reference genome sequence to check for the variations at genomic level.

Publications

1. Arunkumar KP and Nagaraju J (2011). *Drosophila* intersex orthologue in the silkworm, *Bombyx mori* and related species. **Genetica** 139: 141-147.
2. Bentur JS, Sinha DK, Padmavathy C, Revathy C, Muthulakshmi M and Nagaraju J (2011). Isolation and characterization of microsatellite loci in the asian rice gall midge (*Orseolia oryzae*) (Diptera: Cecidomyiidae). **International Journal of Molecular Science** 12: 755-772.
3. Mrinal N, Tomar A and Nagaraju J (2011). Role of sequence encoded κB DNA geometry in gene regulation by Dorsal. **Nucleic Acids Research** 39: 9574-9591.
4. Shukla JN, Jadhav S and Nagaraju J (2011). Novel female-specific splice form of *dsx* in the silkworm, *Bombyx mori*. **Genetica** 139: 23-31.
5. Terenius O, ... (67 authors) ..., Nagaraju J, Richard H, Herrero S, Gordon K, Swevers L and Smagghe G (2011). RNA interference in Lepidoptera: An overview of successful and unsuccessful studies and implications for experimental design. **Journal of Insect Physiology** 57: 231-245.
6. Pidugu VK, Pothula RKS, Narra D and Srivastava V (2012). Development of a multiplex Polymerase Chain Reaction method for specific detection of genetically modified cotton events MON 531 and MON 15985. **International Journal of Basic and Applied Sciences** 1: 45-53.
7. Siddiq EA, Vemireddy LR and Nagaraju J (2012). Basmati rices: Genetics, breeding and trade. **Agricultural Research** 1: 25-36.
8. Singh CP, Singh J and Nagaraju J. A baculovirus-encoded miRNA suppresses its host miRNAs biogenesis by regulating the Exportin-5 co-factor Ran. **Journal of Virology** (In press).

Patent

1. Nagaraju J. Virus resistant transgenic silkworm.
PCT International Application No. PCT/IN2012/000083 filed on 2.02.2012.

LABORATORY OF GENOMICS AND PROFILING APPLICATIONS

Principal Investigator	Madhusudan R Nandineni	Staff Scientist
PhD Students	Anujit Sarkar Soumya Rao	Senior Research Fellow Junior Research Fellow (Since Jul. 2011)
Other Members	Vishakha Sharma S Seethalakshmi G. Sreeja Reddy Srujana Nagireddy	Project Assistant (Till Jan. 2012) Project Assistant (Till Dec. 2011) Project Assistant Project Assistant

Objectives

1. Development, standardization and validation of DNA markers for genetic fidelity testing of tissue culture raised plants and for phylogenetic studies;
2. Development of novel strategies/methodologies for enrichment of human DNA from mixtures containing human and non-human DNAs for DNA profiling-based human identification;
3. To study the human genetic diversity among various population groups of India.

Project 1: Development and validation of DNA-based markers for genetic fidelity testing of tissue culture raised plants and for phylogenetic studies

Summary of work done until the beginning of this reporting year (upto March 31, 2011)

As a referral centre for the genetic fidelity testing of tissue culture-raised plants, it was proposed to employ various molecular markers such as microsatellites or simple sequence repeats (SSRs), Inter-SSRs (ISSR), Inter-Retrotransposon Amplified Polymorphism (IRAP) or Retrotransposon Microsatellite Amplified Polymorphism (REMAP) for testing clonal fidelity in banana, black pepper, potato, sugarcane and vanilla. In potato and banana, after various levels of screening, several IRAP and REMAP primer combinations were shortlisted to distinguish among different varieties as well as for clonal fidelity testing. Based on SSR marker studies, the genetic relatedness among the various varieties of potato and banana were ascertained employing polyacrylamide gel electrophoresis (PAGE) analysis. Further, multiplex PCR assays based on SSR markers were designed for banana, potato and sugarcane for true-to-type testing of tissue culture raised plants.

Details of progress made in the current reporting year (April 1, 2011– March 31, 2012)

(a) Varietal studies using the retrotransposon-based marker systems

As mentioned in our previous report, studies were carried out employing IRAP, REMAP and SSR

markers for development of suitable markers for genetic fidelity testing of tissue culture raised plants and also for phylogenetic studies. In banana, a total of five IRAP and ten REMAP primer combinations were chosen for diversity studies among different banana varieties. In IRAP studies, a total of 56 reproducible bands were obtained, of which 49 were found to be polymorphic with an average of 11 bands per primer. In REMAP studies, a total of 214 reproducible bands were generated, of which 186 were found to be polymorphic, with an average of 21 bands per primer. In sugarcane, nine each of IRAP and REMAP primer combinations were selected for clonal fidelity testing. In potato, total of eighteen IRAP and nine REMAP combinations were chosen to assess the genetic diversity among different varieties. A total of 307 reproducible IRAP bands were produced, out of which 270 were found to be polymorphic (data not shown), whereas in REMAP analysis, a total of 143 reproducible bands were produced, of which 98 were found to be polymorphic.

In vanilla, total of nine IRAP and fifteen REMAP combinations were selected for diversity studies among different vanilla species. A total of 95 IRAP and 135 REMAP reproducible bands were obtained, of which 73 and 111 bands were found to be polymorphic in IRAP and REMAP respectively. Phylogenetic analyses of the retrotransposon-based markers has enabled us in discriminating the various Indian vanilla species. In black pepper, ten IRAP and three REMAP combinations were selected for diversity studies. A total of 51 and 25 reproducible bands were obtained, of which 23 and 15 bands were found to be polymorphic in IRAP and REMAP, respectively.

(b) Phylogenetic studies and genetic fidelity testing employing SSR markers

Various SSR loci reported in the literature for potato and banana crops were tested for their usefulness in genetic fidelity testing and phylogenetic studies. As mentioned in the previous year's report, thirty three of the forty SSR loci tested in case of potato and thirty two of the forty two SSR loci in case of

banana were shortlisted for further analysis based on polymorphism observed in PAGE analysis. Further analysis using capillary-electrophoresis based genotyping employing fluorescently-labeled primers was performed. Data analysis was carried out using standard SSR analysis softwares. In banana, the phylogenetic analysis of 20 *Musa* cultivars employing sixteen SSR primer pairs had discriminated most of the genotypes. The dendrogram obtained showed the presence of three main clusters (A, B and C) having 12, 7 and 1 cultivars, respectively (data not shown). In potato, three main groups were observed in the dendrogram obtained with SSR marker system. Group I, II and III included 22, 20 and 5 varieties, respectively (data not shown). Further work with additional SSR markers would reveal the genetic relatedness at a finer scale among these varieties which would be helpful in devising strategies for crop improvement programmes in banana and potato.

(c) Multiplexing of SSR loci for assessing the clonal fidelity

Based on the banding pattern and informativeness of SSR loci, various SSRs were shortlisted for multiplex assays in different crop plants. The tissue-culture raised micropropagules from these crop plants were used to standardize the SSR multiplex PCR conditions for true-to-type testing.

In banana, ten multiplex (six triplex and four tetraplex) SSR sets were designed employing different combinations of twenty SSR primer pairs and the PCR conditions were also optimized for true-to-type testing. In potato, twenty-eight of the thirty three SSR markers screened were chosen for developing ten multiplex (seven triplex and three tetraplex) SSR sets and were employed in fidelity testing among somaclones of potato. In sugarcane, ten primer pairs were selected for development of eleven triplex sets for true-to-type testing. In vanilla, six primer pairs were chosen to devise four triplex sets for true-to-type testing. In black pepper, ten primer pairs were selected for four triplex and one tetraplex set for genetic fidelity testing. The multiplex reactions had generated identical banding pattern when visualized in 3% agarose gel electrophoresis for all the clones tested among the various crop plants, as one would expect if they were true-to-type. Representative results of clonal fidelity testing in banana and vanilla are shown in Figure 1A and 1B, respectively.

Project 2: Developing novel strategies for enrichment of human DNA from mixtures containing human and non human DNAs for DNA profiling based human identification.

Summary of work done until the beginning of this reporting year (upto March 31, 2011)

The major problems associated with DNA profiling of forensic case work samples for human

identification (HID) are contamination with non-human DNAs and PCR inhibitors. To address these issues, selective enrichment of human STRs had been proposed. Reconstituted samples wherein human and bacterial DNAs were mixed in various ratios up to 1:10,000 by weight yielded successful profiles when enriched with the modified primer extension capture (PEC) methodology prior to amplification of STR loci, whereas no DNA profiles could be generated for the samples without enrichment at high bacterial DNA contamination. Since the modified PEC method had yielded promising results, attempts were made to improve the technique by employing two biotinylated oligos complimentary to the sequences located upstream and downstream of each of the 18 forensically-relevant STR loci for enrichment. Last year, we had reported that the peak heights (relative fluorescence units, RFUs, obtained from the capillary electrophoresis), which represent the amount of enriched product, had increased by up to 35% when compared to the enrichment using only one oligo (either forward or reverse) at every locus. All the subsequent experiments for enrichment of STR loci were carried out using a pair of biotinylated oligos designed to capture both the strands of DNA at each of the 18 STR loci.

Details of progress made in the current reporting year (April 1, 2011 - March 31, 2012)

The main objective of this study was to optimize and compare different enrichment methodologies that would work the best with the forensic case work samples. Towards this goal, we had evaluated three techniques which included PEC, where the biotinylated oligos were allowed to hybridize with target DNA followed by single step polymerization (extension) of the oligo. The second method was short hybridization which was similar to that of PEC except that the hybridized oligos were not extended. In the third method (long hybridization), the biotinylated oligos (bait) were first allowed to bind with streptavidin-coated magnetic beads and incubated with target DNA (hybridization at 60 °C for 48 hrs), followed by washing of unbound contaminants/ non-target DNAs, and elution of the bound fragments, which are expected to contain relevant STRs.

The efficacy of these three methods was evaluated by analyzing the enrichment of STR loci in the simulated samples (reconstituted by mixing human genomic DNA with bacterial DNA or with PCR inhibitors). All the three methods were proficient in generating the profiles up to 1:10,000 ratio of human and bacterial DNA concentrations by weight. However, the long hybridization method was not very consistent. Comparison of the enrichment efficiency of these three methods for few representative STR loci is shown in Figure 2.

Fig. 1**Fig. 2****Fig. 3****Fig. 4****Fig. 5**

Figure 1A. 3% Agarose gel showing the triplex reaction with clones of Grand Naine variety of banana and one of the out group as control. Lane 1- Mother plant (Grand Naine); Lane 2 -21: Clones of Grand Naine; Lane 22- Ankur II out-group. **Figure 1B.** 3% Agarose gel showing the triplex reaction with clones of *Vanilla planifolia* and one out-group as control, Lane 1-10: Clones of *V. planifolia*, Lane 11- *V. andamanica*, Lane M1-100 bp ladder, Lane M2-50 bp ladder. **Figure 2.** Comparison of three methods of enrichment of STR loci in reconstituted samples (1:10,000 ratio of human and bacterial DNA by weight). X-axis: representative STR loci; Y-axis: Relative Fluorescence Units (RFU). **Figure 3.** DNA profile of a sample inhibited by hematin at a concentration of 1.5 mM. Panel 1: without enrichment; Panel 2: Enrichment using PEC method; Panel 3: Enrichment using short hybridization method. **Figure 4.** DNA profile of a sample inhibited by humic acid at a concentration of 0.5 µg/µl. Panel 1: without enrichment; Panel 2: Enrichment using PEC method; Panel 3: Enrichment using short hybridization method. **Figure 5.** DNA profile of a sample inhibited by tannic acid at a concentration of 2 µg/µl. Panel 1: without enrichment; Panel 2: Enrichment using PEC method; Panel 3: Enrichment using short hybridization method. [For Figures 3,4 and 5; X-axis: size of amplified STR loci in base pairs; Y-axis: RFU]

STR-enrichment in the presence of inhibitors of PCR

The commonly employed commercial STR multiplex PCR kits for HID work are tolerant to limited concentrations of inhibitors like humic acid, hematin, phenolic compounds (tannic acid), calcium, etc., which are commonly found in various forensic samples. We tested the above strategy for its effectiveness in enrichment of STR loci in the presence of various concentrations of these potent PCR inhibitors. In preliminary experiments, in the presence of PCR inhibitors, PEC and short hybridization technique (with 1 hour incubation) proved to be more efficient in amplifying simulated forensic samples as compared to long hybridization process (48 hours of incubation). The highest concentrations of inhibitors at which these methods were successful in generating complete DNA profile when 5 ng of human genomic DNA was taken as input were: hematin at 1.5 mM; humic acid at 0.5 µg/µl and tannic acid at 2 µg/µl. The DNA profiles obtained after enrichment of STR loci using PEC and short hybridization methods in presence of various inhibitors are shown in Figures 3, 4 and 5. Eventhough complete DNA profile were obtained there was some background noise with some of the samples. In future experiments, these methods would be standardized further and employed on various kinds of challenging forensic case work samples to test their efficiency to increase the DNA profiling success rate.

Project 3: To study human genetic diversity in various population groups in India

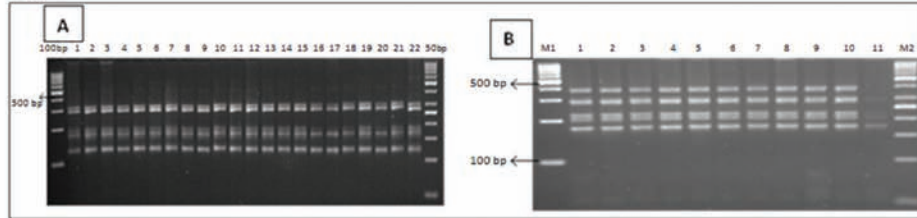
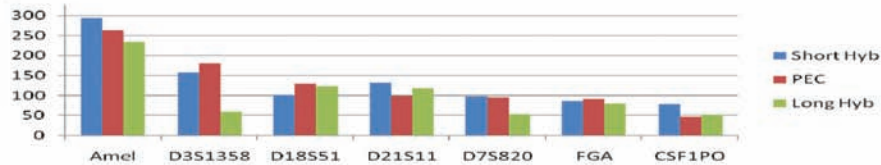
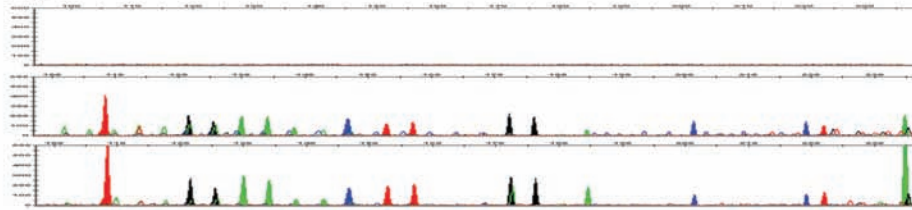
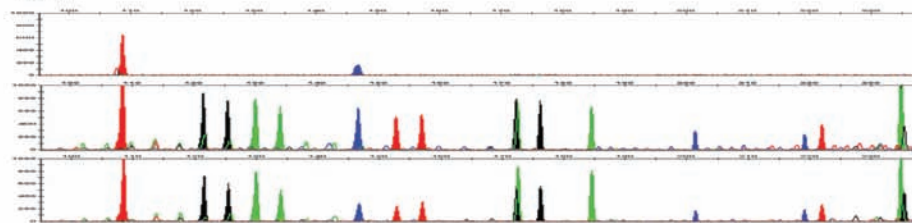
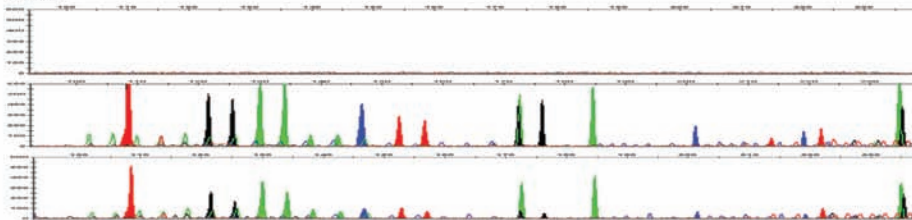
Summary of work done until the beginning of this reporting year (upto March 31, 2011)

Another area of interest of the laboratory is to assess the genetic diversity among different population groups in India and to address questions related to the phenotypic effects of genetic variation(s) within and between population groups. As part of the genotype-phenotype correlation study, it was proposed to validate the putative genetic variants such as single nucleotide polymorphisms (SNPs) that play an important role in determining the common phenotypic traits such as skin pigmentation in different population groups in India. In the previous reports, we had described the strategy and procedure of sample collection from different geographical locations in India. Further, we had reported about the optimization of the Genplex panel (a 48-plex SNP-based genotyping system for HID) and its testing in the

pre-established paternity trios cases, wherein it showed consistent results with those obtained by employing commercial STR multiplex PCR kits.

Details of progress made in the current reporting year (April 1, 2011- March 31, 2012)

(a) Collection of additional samples from volunteers along with phenotypic trait data for genetic variation studies

As mentioned in the previous report, in order to build an efficient SNP-based panel for HID, the allele frequencies of the SNPs should meet the desired characteristics, viz., high heterozygosity and low F_{st} (Wright's F-statistics). In order to determine the distribution of SNPs across various Indian population groups, additional samples from different geographical locations in India were collected. The phenotypes and ancestry related information were collected as per the procedure mentioned in the previous report, except that the collection of hair samples from volunteers was discontinued.

(b) SNP-based study of genetic loci affecting human skin pigmentation in Indian populations

As part of 'forensic phenotyping', common phenotypic traits like skin pigmentation, body-mass index, hair-thickness, etc. were chosen for these studies. The aim was to determine the SNPs that are associated with these phenotypes in Indian populations, so that a prediction can be made about the phenotype of a target individual based on the genotype obtained from the DNA recovered from or at the crime scene, which may help in short-listing a person or a group from a large population. In the present study, genotype-phenotype correlation studies for skin pigmentation were carried out for 40 samples (20 each from Andhra Pradesh and West Bengal) for three SNPs in three genes, which were reported to be associated with skin pigmentation in South-Asian populations in previous studies. The three SNPs rs2762464, rs1426654 and rs1800404 located in genes tyrosinase-related protein-1 (TYRP1), solute carrier protein (SLC24A5) and oculocutaneous albinism protein (OCA2), respectively, were studied by employing the SNaPshot™ genotyping assay (Applied Biosystems, Foster City, USA). The genotypes obtained from these samples, were found to satisfy the Hardy-Weinberg Equilibrium test. Association test of SNPs with skin pigmentation in these two population groups showed that rs2762464 and rs1800404 were not significantly associated with skin pigmentation while the allele G for rs1426654 (A/G) showed significant

association with higher melanin index. Future work employing additional loci implicated in determining skin pigmentation will be undertaken in different Indian populations.

(c) Evaluation of the SNP-based GenPlex (48-plex) panel in some Indian populations

As mentioned previously, the forensically relevant SNPs reported elsewhere were tested in Indian populations for their applicability in HID purposes. The GenPlex panel was employed according to the manufacturer's instructions for genotyping the samples in populations from different states which included Jharkhand, Andhra Pradesh, Tamil Nadu, Rajasthan and West Bengal. In the initial phase, around 20 random samples from each population were genotyped with GenPlex panel to obtain the allele frequencies of the concerned loci in these populations. Only about 15-20 SNPs fulfilled the desired criteria of high heterozygosity and low F_{st} , while the others did not satisfy the said criteria. Considering the high genetic diversity of India, such a difference is not unexpected and hence, it was decided to incorporate additional SNPs, which would meet the criteria for HID purposes, to the proposed HID SNP panel by screening various SNP databases.

(d) Screening of SNP databases to filter additional SNPs for HID purposes

In order to screen SNPs from various databases in the public domain, following filters were employed:

(a) Minor allele frequency (MAF) of the SNPs should be equal or greater than 0.4, (b) Wright's

F-statistics (F_{st}) should be equal to or less than 0.02, (c) the SNPs should have no known reported functional role, (d) there should be no conservation of flanking regions of SNPs across species, and (e) the SNPs should not be located in low complexity regions of the genome (high AT/GC rich sequences or repetitive regions). After screening for the above mentioned criteria, a panel of about 500 SNPs was shortlisted from various SNP databases. In future work, further screening on the basis of genomic location and linkage probabilities would be carried out prior to testing and validating them by performing genotyping experiments in the Indian populations for HID purposes.

Publications

1. Gunnarsdóttir ED, Nandineni MR, Li M, Myles S, Gil D, Pakendorf B and Stoneking M (2011). Larger mtDNA than Y-chromosome differences between matrilineal and patrilineal groups from Sumatra. *Nature Communications* 2: 228.
2. Reich D, Patterson N, Kircher M, Delfin F, Nandineni MR, Pugach I, Ko AMS, Ko YC, Jinam TA, Phipps ME, Saitou N, Wollstein A, Kayser M, Paabo S and Stoneking M (2011). Denisova admixture and the first modern human dispersals into Southeast Asia and Oceania. *American Journal of Human Genetics* 89: 516-528.
3. Ranganath P, Sharma V, Danda S, Nandineni MR and Dalal A. Report of novel mutations in the lysosomal sialidase (NEU1) gene in Indian cases of sialidosis. *Indian Journal of Medical Research* (In press).

LABORATORY OF FUNGAL PATHOGENESIS

Understanding the Pathobiology of an Opportunistic Human Fungal Pathogen *Candida glabrata*

Principal Investigator	Rupinder Kaur	Staff Scientist
PhD Students	Gaurav Maruti Nandan Rai Sapan Borah Vivek Kumar Srivastava Mubashshir Rasheed	Senior Research Fellow Senior Research Fellow Senior Research Fellow Junior Research Fellow Junior Research Fellow (Since Jan. 2012)
Other Members	Sriram Balusu Shivarathri Raju Rosalin Sahoo Suneetha KJ	Project Assistant Project Assistant Project Assistant (Till Feb. 2012) Technical Officer (Since Dec. 2011)

Candida species are the leading cause of invasive mycoses with *Candida albicans* being the most prevalent species. *C. glabrata*, a regular commensal of human oral cavity and gastro-intestinal tract, causes infections ranging from superficial mucosal to disseminated life-threatening infections under conditions of immuno-compromise and is the second or third most frequently isolated *Candida* species from Intensive Care Unit patients depending upon the geographical location. Treatment of *C. glabrata* infections is limited by its low inherent susceptibility towards a widely used antifungal drug fluconazole. Research in our laboratory is focused on the elucidation of the molecular basis of intrinsic resistance of *C. glabrata* towards antifungal fluconazole, better understanding of the interaction of *C. glabrata* with the host immune cells, and the iron uptake and homeostasis mechanisms operational in *C. glabrata*.

Project 1: Functional genomic analysis of *C. glabrata*-macrophage interaction

Objectives

1. Analysis of intra-cellular behavior;
2. Screening of a *C. glabrata* mutant library for altered survival profiles;
3. Identification and analysis of the genes required for survival *in vitro*.

Summary of the work done until the beginning of this reporting year (upto March 31, 2011)

Using an *in vitro* system comprised of the human monocytic cell line THP1, we showed that wild-

type *C. glabrata* cells were able to replicate while a mutant lacking aspartyl proteases was killed upon co-incubation with THP-1 macrophages for 24 h. Screening of a *C. glabrata* mutant library (18,432 mutants; generated by homologous recombination of *in vitro* generated Tn7 insertions in *C. glabrata* genomic clones) for altered survival profiles in THP-1 macrophages *via* signature-tagged mutagenesis (STM) approach identified a total of 168 mutants, 35 'up' and 133 'down' mutants which displayed increased and reduced survival in human macrophages, respectively. Tn7 insertion mapping in the down mutants identified a set 56 genes, belonging to diverse biological processes including chromatin organization and golgi vesicle transport, which are required for survival and/or replication of *C. glabrata* in macrophages. We also reported that *C. glabrata* wild-type cells (*wt*) respond to the intracellular milieu of macrophages by modifying their chromatin architecture, and chromatin extracted from macrophage-internalized *C. glabrata* cells displayed resistance to micrococcal nuclease (MNase) digestion.

Details of the progress made in the current reporting year (April 1, 2011 – March 31, 2012)

To further investigate the role for chromatin remodeling in survival in THP-1 macrophages, we created knock-outs for five genes (*CgRSC3-A*, *CgRSC3-B*, *CgRTT107*, *CgRTT109*, and *CgSGS1* genes) belonging to the GO category of either chromatin organization or DNA damage, which were identified through the STM screen. *CgRsc3-A* and *CgRsc3-B* are the orthologs of *Saccharomyces cerevisiae* Rsc3 which possesses

sequence-specific DNA binding transcription factor activity and is a component of a 17-subunit RSC (remodel the structure of chromatin) complex. *CgRTT109* encodes an acetyltransferase, whose counterpart in *S. cerevisiae* acetylates lysine 56 on histone H3 and functions in DNA replication and maintenance of genomic stability. Orthologs of *CgRTT107* and *CgSGS1* in *S. cerevisiae* code for a BRCT (BRCA1 C Terminus) domain-containing protein and a RecQ-related nucleolar DNA helicase, respectively and are implicated in DNA double-strand break repair.

Phenotypic characterization of the *Cgrsc3-aΔ*, *Cgrsc3-bΔ*, *Cgrtt107Δ*, *Cgrtt109Δ* and *Cgsgs1Δ* mutants revealed similar growth profiles in YPD and RPMI medium and replication defects in single infection assays with THP-1 macrophages (Figure 1A). Notably, deletion of the two ORFs coding for CgRsc3 did not aggravate the replication defect in *Cgrsc3-aΔbΔ* mutant (Figure 1A). Further, *Cgrtt107Δ* and *Cgrtt109Δ* exhibited sensitivity to MMS, CPT and H₂O₂ while the growth of *Cgrsc3-aΔ*, *Cgrsc3-bΔ*, *Cgrsc3-aΔbΔ* was impaired only in the presence of H₂O₂. Surprisingly, *Cgsgs1Δ*, unlike its *S. cerevisiae* counterpart, grew like *wt* in the presence of DNA damaging and oxidative stress causing agents suggesting that CgSgs1 is not essential for processing of DNA double-strand breaks in *C. glabrata*.

To demonstrate that *CgRSC3-A* and *CgRTT109* are involved in maintaining the chromatin structure in *C. glabrata*, we performed MNase digestion assay. Chromatin extracted from the YPD-grown logarithmic-phase *Cgrsc3-aΔ*, *Cgrsc3-aΔbΔ* and *Cgrtt109Δ* cells exhibited enhanced resistance to MNase digestion (Figure 1B) suggesting an altered chromatin architecture in the mutant cells.

To investigate if the altered chromatin structure of *Cgrsc3-aΔ* and *Cgrtt109Δ* lead to differential gene expression, we performed microarray analysis on 10 h RPMI-grown and macrophage-internalized *wt* and mutant cells. Comparison of the transcript profiles of RPMI-grown *Cgrsc3-aΔ* and *Cgrtt109Δ* cells with those of the RPMI-cultured *wt* cells revealed 724 and 819 genes to be differentially regulated, respectively. Intriguingly, this gene set revealed a striking overlap with 300 induced and 252 repressed genes common to both the mutants indicating similar global regulatory roles for *CgRSC3-A* and *CgRTT109* in cellular physiology. The common induced gene set included genes involved in chromatin silencing and remodeling, RNA metabolism, ergosterol biosynthesis, DNA

replication and repair. The repressed gene set included genes belonging to tricarboxylic acid cycle, iron-sulfur cluster assembly and mitochondrial electron transport. Further, genes implicated in DNA-dependent regulation of transcription and protein phosphorylation were uniquely down-regulated in *Cgrsc3-aΔ* and *Cgrtt109Δ* mutant respectively, while genes implicated in protein glycosylation were uniquely up-regulated in the *Cgrtt109Δ* mutant.

A total of 214, 432 and 683 genes were found to be differentially expressed in *wt*, *Cgrsc3-aΔ* and *Cgrtt109Δ* cells respectively, in response to macrophage internalization. Of these, 100, 219 and 346 were induced and 114, 213 and 337 were repressed in *wt*, *Cgrsc3-aΔ* and *Cgrtt109Δ* cells respectively. Up-regulation of the genes involved in ammonium transport, glyoxylate cycle, β -oxidation of fatty acids, meiosis, signal transduction and proteolysis was observed in *wt* cells while the repressed genes were implicated in iron transport and homeostasis, ergosterol biosynthesis, cell wall metabolism and response to stress. The repression of reductive high-affinity iron assimilation in 10 h macrophage-internalized *C. glabrata* cells implies either an iron-rich internal milieu of macrophages or an anaerobic environment.

Similar to the *wt*, macrophage-internalized *Cgrsc3-aΔ* and *Cgrtt109Δ* cells showed up-regulation of tricarboxylic acid cycle, β -oxidation of fatty acids and signal transduction, and down-regulation of iron-metabolism, ergosterol biosynthesis and cell wall metabolism. However, contrary to *wt* cells, *Cgrsc3-aΔ* and *Cgrtt109Δ* cells, upon macrophage internalization, displayed induction of genes implicated in the generation of precursor of metabolites and energy, cellular respiration, iron-sulfur cluster assembly and amino acid metabolism, suggesting that the mutant cells, probably owing to global changes in their chromatin architecture, are unable to mount an appropriate response to restrain cellular energy metabolism in response to macrophage internal milieu.

Lastly, to examine if chromatin remodeling is important for the virulence of *C. glabrata*, we assessed the fungal burden for *wt* and the mutants in the murine model of systemic candidiasis. While we were able to recover 6×10^5 yeast from the kidneys of mice infected with *wt* *C. glabrata* cells, 25- to 50-fold lower yeast CFUs were obtained from *Cgrsc3-aΔ*, *Cgrsc3-bΔ* and *Cgrsc3-aΔbΔ* and 3- to 5-fold lower CFUs for *Cgrtt107Δ*, *Cgrtt109Δ* and *Cgsgs1Δ* infected mice (Figure 1C). No

significant differences in the fungal burden were seen in the liver and spleen of *wt* and *Cgrsc3Δ* infected mice (Figure 1C). The yeast CFUs recovered from the liver of *Cgrtt107Δ* and *Cgsgs1Δ* infected mice was ~2-fold lower than the *wt*-infected mice (Figure 1C). Interestingly, *Cgrtt109Δ* mutant showed reduced survival in all the three target organs, kidney, liver and spleen (Figure 1C). Together, these data implicate *CgRSC3-A*, *CgRSC3-B*, *CgRTT107*, *CgRTT109*, and *CgSGS1* genes in the survival of *C. glabrata* in a mammalian host. Currently, we are trying to investigate the link between globally altered chromatin architecture and the metabolic adaptation and replication of *C. glabrata* cells in the macrophage milieu.

2. Identification of targets for combinatorial therapy with azole antifungals.

Summary of the work done until the beginning of this reporting year (upto March 31, 2011)

We have previously screened 9,134 *C. glabrata* Tn7 insertional mutants for their inability to survive fluconazole (a fungistatic azole antifungal) stress and identified two components of RNA polymerase II mediator complex (CgMed2 and CgPgd1), three players of Rho GTPase-mediated signaling cascade (CgBem2, CgSlt2 and CgBnr1) and two proteins implicated in actin cytoskeleton biogenesis (CgPan1) and ergosterol biosynthesis (CgErg4) respectively, which are required to sustain viability during fluconazole stress. Notably, Rho1,

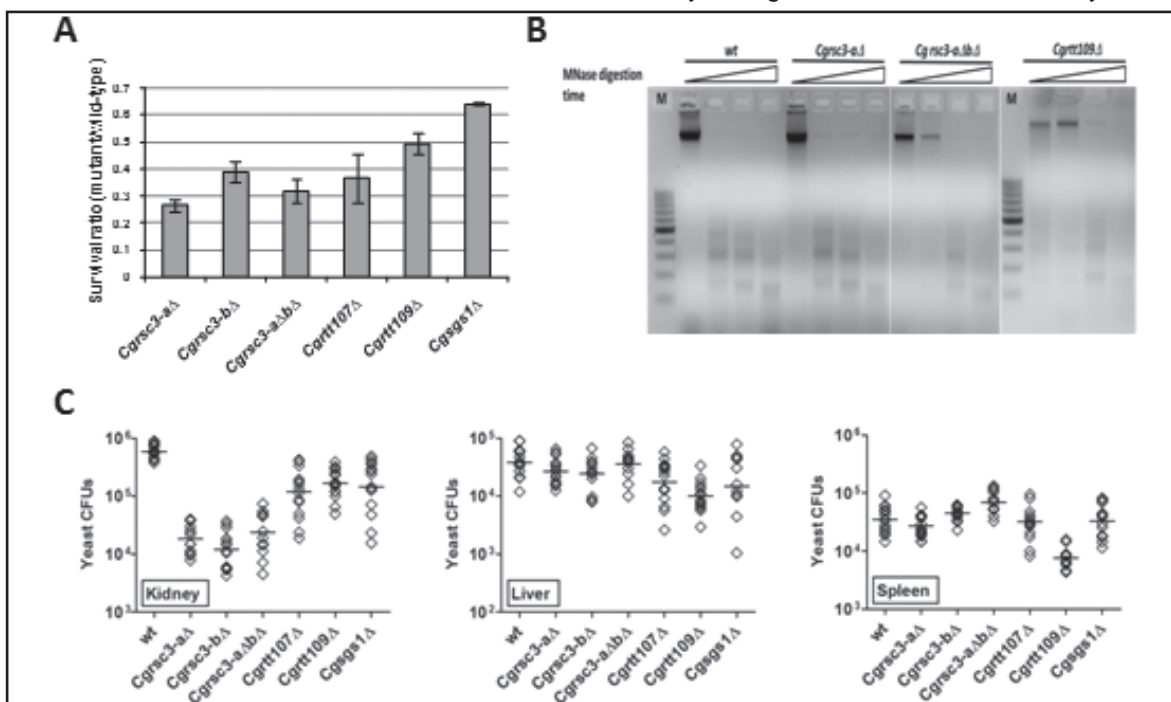

Figure 1. Genes involved in chromatin organization and DNA repair are required for virulence of *C. glabrata*. A. Single-*C. glabrata* strain infections of PMA-activated THP-1 cells to assess the number of intracellular yeast. THP-1 macrophages were lysed 2 h and 24 h post infection and cell lysates were plated onto YPD medium to enumerate the viable *C. glabrata* cells. Increase in CFUs for each strain was determined by dividing the CFUs obtained at 24 h with those for 2 h. Survival ratio represent the CFU ratio of mutant/wild type after 24 h of infection. B. Chromatin of *Cgrsc3-aΔ*, *Cgrsc3-aΔ bΔ* and *Cgrtt109Δ* mutants display reduced sensitivity to micrococcal nuclease digestion. Chromatin extracted from cells grown in YPD medium were treated with MNase at 10 units/ml for 15 min and 200 ng digested samples were resolved by agarose gel electrophoresis. C. Mutants defective in chromatin organization and DNA damage repair are attenuated for virulence. BALB/c mice were infected with *C. glabrata* cells intravenously and sacrificed 7 days after infection. Diamond and bar represent CFUs recovered from the target organs for individual mice and the geometric mean (n=13-16) of the CFUs per organ, respectively.

Project 2: Innate resistance of *C. glabrata* to fluconazole

Objectives

1. Understanding the molecular basis of low inherent susceptibility of *C. glabrata* towards fluconazole;

a small guanosine triphosphatase, is an upstream component of Pkc1 (Protein kinase C)-activated cell wall integrity (CWI) MAPK cascade in *S. cerevisiae* and is positively and negatively regulated by GDP-GTP exchange factors and GTPase-activating proteins (GAPs), and GDP dissociation inhibitors (GDIs), respectively.

Details of the progress made in the current reporting year (April 1, 2011 – March 31, 2012)

To investigate the role for Rho1-regulated PKC-mediated signaling in the survival of fluconazole stress in *C. glabrata*, we first focused on *CgBEM2* and *CgSLT2* which are predicted to code for a Rho1 GTPase activating protein (RhoGAP) and a serine/threonine MAP kinase, respectively. The ortholog of *CgBem2* in *S. cerevisiae* negatively regulates Rho1 and is implicated in cell polarity and morphogenesis, cell wall integrity and actin cytoskeleton biogenesis. *Slt2* in *S. cerevisiae* is the terminal serine/threonine MAP kinase of the PKC cascade and regulates the cellular response, through the activation of the transcription factors *Swi4/Swi6* and *Rlm1*, to environmental stress signals. To examine the role of *CgBem2* and *CgSlt2* in cellular response to fluconazole, we deleted the *CgBEM2* and *CgSLT2* genes with the dominant nourseothricin resistance marker. Phenotypic characterization of the *Cgbem2* Δ and *Cgslt2* Δ knock-outs revealed sensitivity to fluconazole (Figure 2A) which was complemented by the ectopic expression of the respective genes from plasmids (Figure 2A). Interestingly, growth of *Cgbem2* Δ was strongly attenuated at a higher temperature of 42°C (Figure 2A). Further, microscopic examination of *Cgbem2* Δ cells revealed defects in bud emergence and variations in size and morphology with average size range of 4-7 μm compared to the mean cell size of 3.9 μm in *wt*. A typical logarithmic-phase culture of *Cgbem2* Δ accumulated a high percentage (20-25%) of the cells as oversized, large, un/small-budded cells harboring multiple nuclei (Figure 2B) indicative of *CgBem2*'s role in bud emergence.

To investigate if *CgBem2* acts as a negative regulator of *CgRho1*, we examined the phosphorylation state of *CgSlt2* (an indicator of *Pkc1* activation) in *Cgbem2* Δ cells *via* an antibody that detects only the doubly phosphorylated (active) form of *CgSlt2*. Fluconazole exposure led to the appearance of both, a 56 kDa band corresponding to phosphorylated *CgSlt2*, in *wt* cell extracts, as well as a three-fold increase in total *CgSlt2* levels (Figure 2C). Compared to the *wt* cells, basal levels of *CgSlt2* phosphorylation were elevated in the *Cgbem2* Δ strain and a further two-fold induction was seen upon drug exposure (Figure 2C). Importantly, ectopic expression of *CgBEM2* in *Cgbem2* Δ mutant resulted in phosphorylated *CgSlt2* levels comparable to those of the *wt* cells (Figure 2C). Together, these findings suggest that Rho1-dependent *CgPkc1*-mediated CWI signaling cascade is constitutively active in *C. glabrata* mutants lacking *CgBem2*.

Next, to examine the link between the constitutively active *CgRho1*-*Pkc1* signal transduction cascade and survival of fluconazole stress, we checked whether inhibition of PKC signaling could rescue the fluconazole-induced cell death in *Cgbem2* Δ mutant. We found that while co-treatment of *wt* cells with fluconazole and staurosporine (PKC inhibitor) had a cidal effect with only 15% cells remaining viable, addition of staurosporine increased the viability of fluconazole-treated *Cgbem2* Δ cells to 43% from 29% (Figure 2D). Notably, a synergistic cidal effect of fluconazole was observed with geldanamycin (Hsp90 inhibitor) in *wt* and *Cgbem2* Δ cells with both strains displaying survival rates of 15% (Figure 2D). FK506, a calcineurin signaling inhibitor, was used as a control as it had previously been shown to act synergistically with fluconazole in *C. glabrata* (Figure 2D). Together, these results suggest that the inability of *Cgbem2* Δ cells to survive fluconazole stress is partly owing to a hyperactivated *CgPkc1*-mediated CWI pathway.

To decipher the molecular mechanism for enhanced susceptibility of *Cgbem2* Δ strain towards fluconazole, we examined the expression of three genes (*CgCDR1*, *CgCDR2* and *CgSNQ2*) encoding plasma membrane ATP-binding cassette transporters, and two genes (*CgPDR1* and *CgERG11*) which code for a zinc finger transcriptional regulator of pleiotropic drug resistance genes, and lanosterol 14- α -demethylase (target of fluconazole), respectively. These genes have previously been reported to contribute to azole resistance in *C. glabrata*. Consistent with the earlier reports, *wt C. glabrata* cells responded to fluconazole exposure by elevating the expression of genes coding for drug transporters, *Cdr1*, *Cdr2* and *Snq2* and the transcriptional factor *CgPdr1* (Figure 2E). In contrast, fluconazole-treated cells of *Cgbem2* Δ showed neither induction of the genes coding for ABC transporters nor for the transcriptional regulator (Figure 2E). However, fluconazole-induced transcriptional activation of *CgERG11* (3-4 fold) and *CgSLT2* (2.5 fold) was observed in both *wt* and *Cgbem2* Δ cells excluding the possibility of global transcriptional defects in the *Cgbem2* Δ mutant. (Figure 2E). These findings implicate *CgBem2*, a negative regulator of *CgRho1* GTPase, in the up-regulation of genes coding for multidrug transporters upon fluconazole exposure. Experiments are currently underway to investigate the link between *CgBem2* function and the activation of efflux pumps and survival of azole stress.

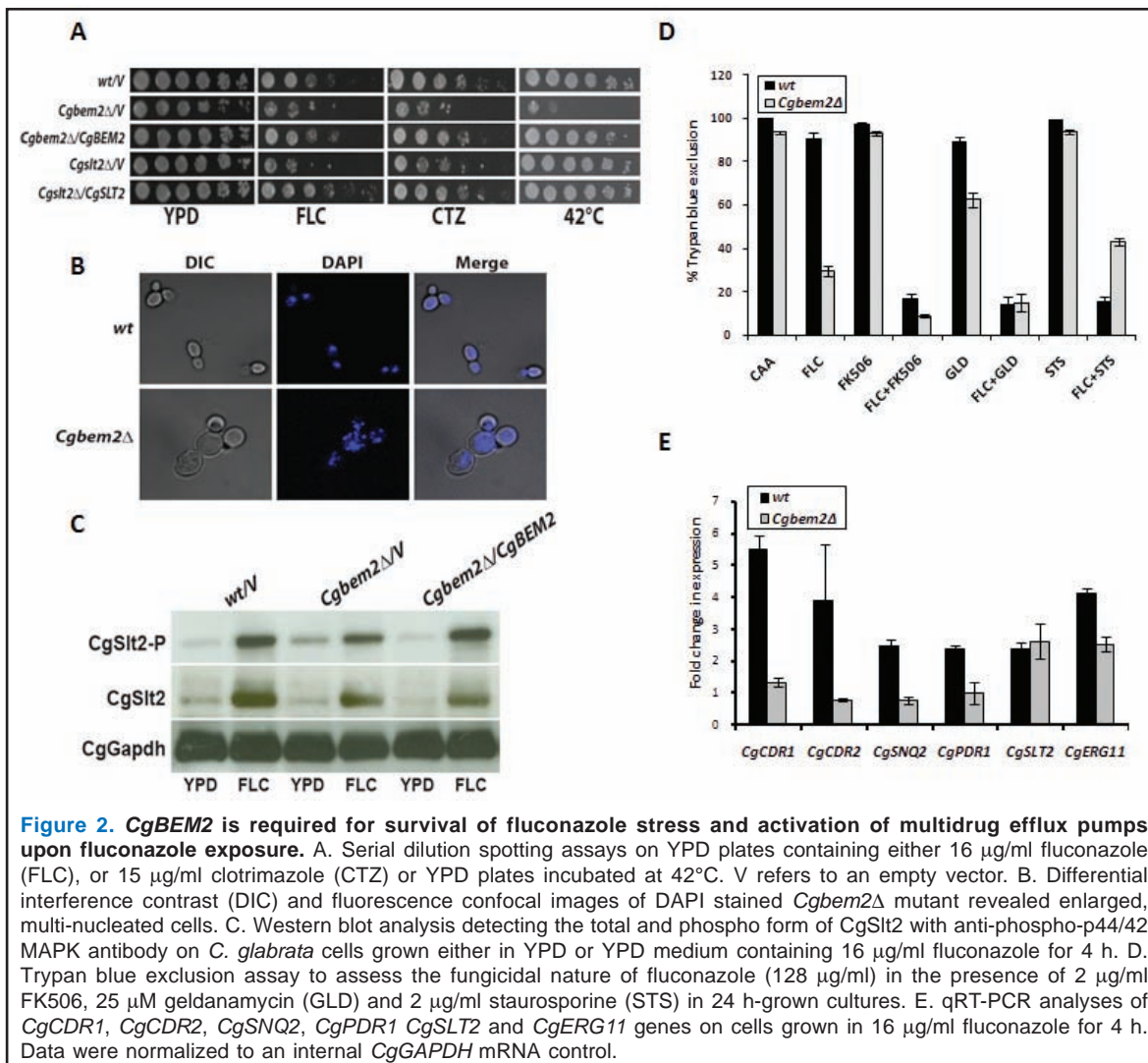

Publications

1. Bairwa G and Kaur R (2011). A novel role for a glycosylphosphatidylinositol-anchored aspartyl protease, CgYps1, in the regulation of pH homeostasis in *Candida glabrata*. ***Molecular Microbiology*** 79: 900-913.
2. Borah S, Shivarathri R and Kaur R (2011). The Rho1 GTPase-activating protein CgBem2 is required for survival of azole stress in *Candida glabrata*. ***Journal of Biological Chemistry*** 286: 34311-34324.
3. Yadav AK, Desai PR, Rai MN, Kaur R, Ganesan K and Bachhawat AK (2011). Glutathione biosynthesis in the yeast pathogens *Candida glabrata* and *Candida albicans*: Essential in *C. glabrata*, and essential for virulence in *C. albicans*. ***Microbiology*** 157: 484-495.

LABORATORY OF IMMUNOLOGY

Understanding the Role of Advanced Glycation End Products (AGE) in Inducing Inflammation, Apoptosis, and Lipogenesis

Principal Investigator	Sunil K Manna	Staff Scientist
PhD Students	Sidhartha K Mahali S Adeel Husain Zaidi Raveendra Babu M Neeharika Verma Pankaj Gupta	Senior Research Fellow Senior Research Fellow Senior Research Fellow Junior Research Fellow Junior Research Fellow (Since Jul. 2011)
Other Members	Nune Ravi Prakash T Navaneeta	Project Senior Research Fellow Technical Assistant
Collaborators	Biswadev Bishayi Chitta S Kumar	Calcutta University, Kolkata SK University, Anantapur

Objectives

1. Understanding and regulation of advanced glycation endproducts (AGE)-mediated inflammation, obesity and diabetic responses;
2. Detection of the molecular mechanisms mediated by novel small molecules to induce anti-inflammatory, anti-teratogenic, and anti-tumorigenic responses;
3. Regulation of cytokine receptors to regulate tumorigenesis and inflammatory responses.

Summary of work done until the beginning of this reporting year (upto March 31, 2011)

Considering the role of retinoids in regulation of more than 500 genes involved in cell cycle and growth arrest, a detailed understanding of the mechanism and its regulation is useful for therapy. In this report, we prove the detailed mechanism of regulation of retinoic acid-mediated cell signaling by azadirachtin, an active component of neem extract. Our data suggest that azadirachtin interacts with retinoic acid receptors and suppresses ATRA binding, inhibits falling off the receptors and activates transcription factors like CREB, Sp1, NF- κ B, etc. Thus, azadirachtin exerts anti-inflammatory and anti-metastatic responses by a novel pathway which would be beneficial for further anti-inflammatory and anti-cancer therapies (Thoh *et al.*, J. Biol. Chem., 286: 4690-4702, 2011). The *Dracaena* resin is widely used in traditional medicine as an anti-cancer agent and benzofuran lignin is the active component in it. Our data suggest that benzofuran lignin-mediated cell death

is partially dependent upon NF- κ B, but predominantly dependent on p53. Thus, this novel benzofuran lignin derivative can be an effective chemopreventive agent against malignant T-cells (Manna *et al.*, J. Biol. Chem., 285: 22318-22327, 2010). Doxorubicin is one of the most effective molecules used in the treatment of various tumors. We provided evidence that doxorubicin-induced cell death was more aggressive (faster and intense) in p53 negative breast as well as other tumor cells. The basal expression of Ras oncoprotein was more in p53 positive cells that might increase the basal expression of Fas in these cells. Overexpression of Ras decreased the amount of Fas in p53 negative cells thereby decreasing doxorubicin-mediated aggressive cell death. Overall, this study helped to understand the much studied chemotherapeutic drug, doxorubicin-mediated cell signaling cascade that leads to cell death in p53 positive and negative cells. High basal expression of Fas might be an important determinant in doxorubicin-mediated cell death in p53 negative cells (Manna *et al.*, J. Biol. Chem., 286: 7339-7347, 2011).

Details of progress made in the current reporting year (April 1, 2011 - March 31, 2012)

Project 1: Double-edged sword effect of biochanin to inhibit nuclear factor kappaB: Suppression of serine/threonine and tyrosine kinases

Several protein tyrosine kinase (PTK) inhibitors predominantly isoflavones, such as genistein, erbstatin, quercetin, daidzein, present in red clover,

cabbage and alfalfa, show apoptotic effects against cancer cells. In this study, we found that biochanin, a methoxy form of genistein (Figure 1A), inhibits IL-8-mediated activation of nuclear transcription factor kappaB (NF- κ B) (Figure 1B), activator protein 1 (AP-1), and NF- κ B-dependent genes like ICAM1 and Cox2 (Figure 1C) more potently than genistein as shown in Jurkat T-cell line. Both biochanin and genistein potently inhibited activity of Lck and Syk (Figure 1F and 1G, lower panels), but biochanin

specifically inhibited activity of IKK (Figure 1G, upper panels). Biochanin inhibited completely NF- κ B activation induced by PMA, LPS, pervanadate (PV), or H₂O₂, but only partially that induced by TNF α . Genistein was unable to inhibit IL-8-induced IKK activity, but it blocked PV-induced IKK activity. Biochanin inhibited activation of NF- κ B by TRAF6 completely, but by TRAF2 partially. *In silico* data suggested that biochanin interacted more strongly with serine/threonine kinase than genistein (Figure

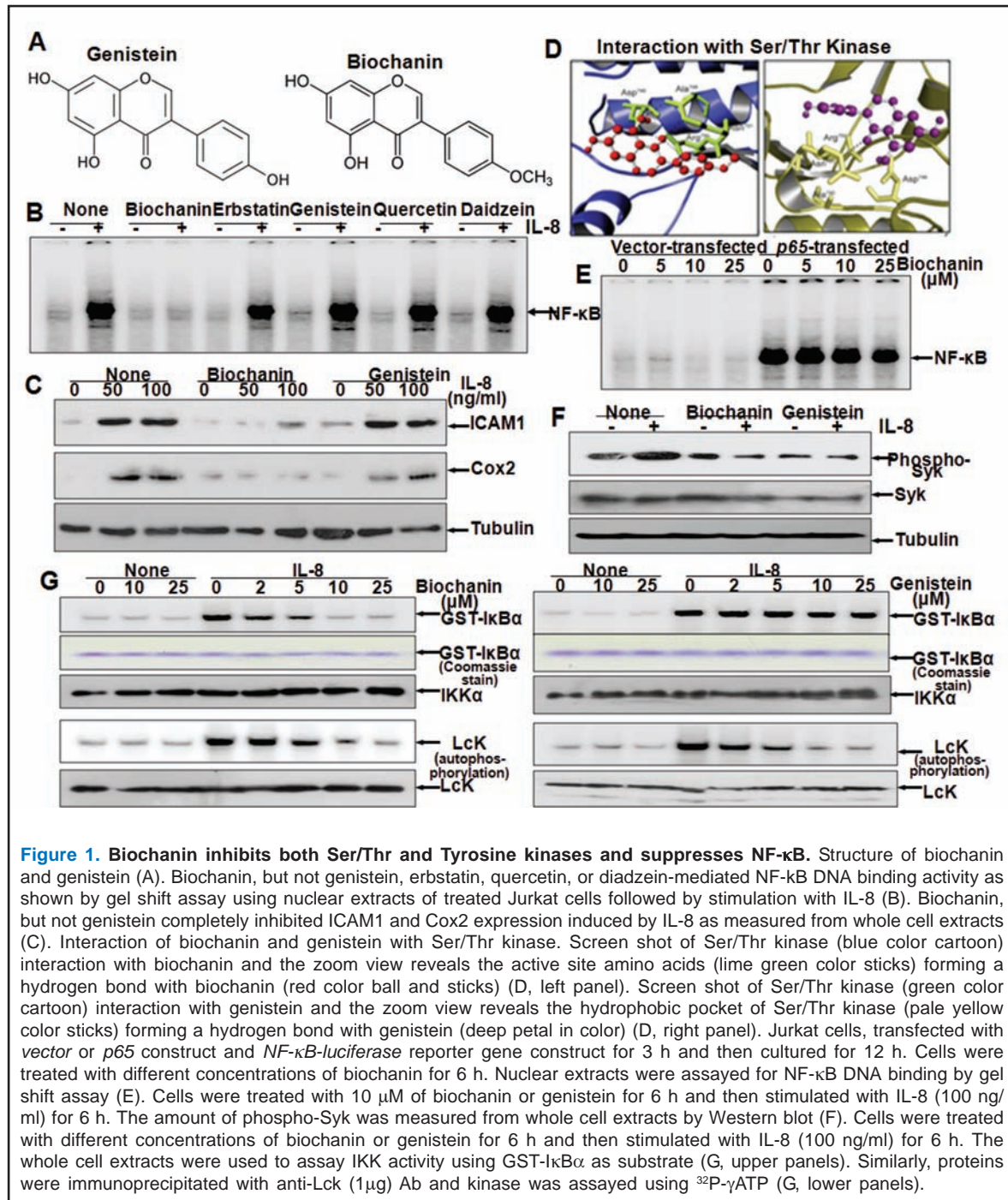

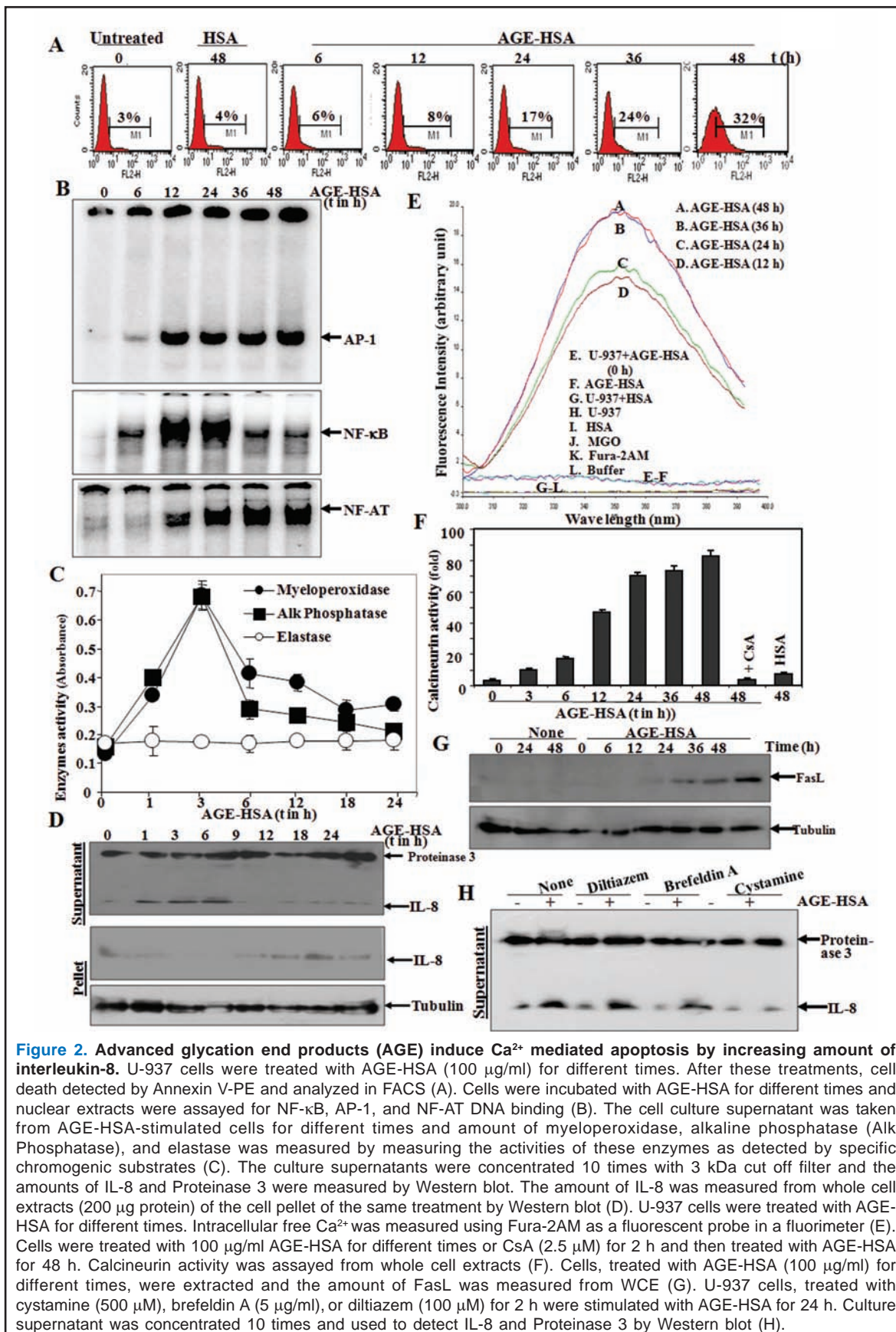

Figure 2. Advanced glycation end products (AGE) induce Ca^{2+} mediated apoptosis by increasing amount of interleukin-8. U-937 cells were treated with AGE-HSA (100 $\mu\text{g}/\text{ml}$) for different times. After these treatments, cell death detected by Annexin V-PE and analyzed in FACS (A). Cells were incubated with AGE-HSA for different times and nuclear extracts were assayed for NF- κB , AP-1, and NF-AT DNA binding (B). The cell culture supernatant was taken from AGE-HSA-stimulated cells for different times and amount of myeloperoxidase, alkaline phosphatase (Alk Phosphatase), and elastase was measured by measuring the activities of these enzymes as detected by specific chromogenic substrates (C). The culture supernatants were concentrated 10 times with 3 kDa cut off filter and the amounts of IL-8 and Proteinase 3 were measured by Western blot. The amount of IL-8 was measured from whole cell extracts (200 μg protein) of the cell pellet of the same treatment by Western blot (D). U-937 cells were treated with AGE-HSA for different times. Intracellular free Ca^{2+} was measured using Fura-2AM as a fluorescent probe in a fluorimeter (E). Cells were treated with 100 $\mu\text{g}/\text{ml}$ AGE-HSA for different times or CsA (2.5 μM) for 2 h and then treated with AGE-HSA for 48 h. Calcineurin activity was assayed from whole cell extracts (F). Cells, treated with AGE-HSA (100 $\mu\text{g}/\text{ml}$) for different times, were extracted and the amount of FasL was measured from WCE (G). U-937 cells, treated with cystamine (500 μM), brefeldin A (5 $\mu\text{g}/\text{ml}$), or diltiazem (100 μM) for 2 h were stimulated with AGE-HSA for 24 h. Culture supernatant was concentrated 10 times and used to detect IL-8 and Proteinase 3 by Western blot (H).

1D), though both equally interacted with PTK. Biochanin was unable to inhibit NF- κ B DNA binding in p65-overexpressed cells (Figure 1E). The data shows that both biochanin and genistein are potent inhibitors of PTK, but biochanin is a potent inhibitor of serine/threonine kinase too. Formononetin, having hydroxyl methoxy group is a less potent inhibitor of IKK than biochanin. Biochanin inhibits NF- κ B activation not only by blocking the upstream IKK, but also PTK that phosphorylate tyrosine residues of I κ B α . Thus, the double-edged sword effect of inhibition of NF- κ B via inhibition of both serine/threonine kinase and PTK by biochanin might show useful therapeutic value against activities of cells that lead to tumorigenesis and inflammation. Overall, the data suggests that bifunctional biochanin might be an important target to regulate cellular physiology by inactivating both Ser/Thr and tyrosine kinases at very low concentrations where no toxic effect is seen. Thus, the double-edged sword effect of biochanin to inhibit cellular kinases may be useful to regulate several biological responses that are deleterious to cells, and use this molecule as a therapeutic.

Project 2: Advanced glycation end products (AGE) induce apoptosis via a novel pathway: Involvement of Ca²⁺ mediated by interleukin-8

Advanced glycation end products (AGE) accumulate in diabetic patients due to high blood glucose levels and cause multiple deleterious effects. In this report we provide evidence that the AGE increased cell death (Figure 2A), one such deleterious effect. Methyl glyoxal coupled human serum albumin (AGE-HSA) induced transcription factors like NF- κ B, NF-AT, and AP-1 (Figure 2B). AGE acts through its cell surface receptor, RAGE and degranulates vesicular contents (Figure 2C) including interleukin-8 (IL-8) (Figure 2D). The number of RAGE, as well as NF- κ B activation, is low but the cell death is more in neuronal cells upon AGE-treatment. Degranulated IL-8 acts through its receptors, IL-8Rs and induces sequential events in cells – increase in intracellular Ca²⁺ (Figure 2E), activation of calcineurin (Figure 2F), dephosphorylation of cytoplasmic NF-AT, nuclear translocation of NF-AT, and expression of FasL (Figure 2G). Expressed FasL increases activity of caspases and induces cell death. Though AGE increases amount of ROI, accompanying cell death is not dependent upon ROI. By inhibiting degranulation, the amount of AGE-mediated cell death was reduced and this correlated with the amount of IL-8 degranulation (Figure 2H). Thus,

this study may be important in several age-related neuronal diseases where AGE-induced apoptosis is observed because of high amounts of AGE.

We report here for the first time that the early events mediated by AGE signaling leads to cell death proceeding through release of IL-8. IL-8-mediated cellular responses lead to activation of calcineurin, nuclear translocation of NF-AT, and expression of FasL. As an early response, AGE degranulates several proteolytic enzymes and cytokines and these molecules induce inflammatory responses. The previous reports that dealt with deleterious effect of AGE in cells might be answered through our findings. Thus, this study has immense importance to understand the mechanism of action of AGE to induce its deleterious effects like neurodegeneration in physiological conditions, especially in diabetic and aged persons.

Publications

1. Kole L, Giri B, Manna SK, Pal B and Ghosh S (2011). Biochanin-A, an isoflavon, showed anti-proliferative and anti-inflammatory activities through the inhibition of iNOS expression, p38-MAPK and ATF-2 phosphorylation and blocking NF- κ B nuclear translocation. *European Journal of Pharmacology* 653: 8-15.
2. Mahali S, Raviprakash N, Raghavendra PB and Manna SK (2011). Advanced glycation end products (AGEs) induce apoptosis via a novel pathway: Involvement of Ca²⁺ mediated by interleukin-8 protein. *Journal of Biological Chemistry* 286: 34903-34913.
3. Majumdar S, Dutta K, Manna SK, Basu A and Bishayi B (2011). Possible protective role of chloramphenicol in TSST-1 and coagulase positive *Staphylococcus aureus* induced septic arthritis with altered levels of inflammatory mediators. *Inflammation* 34: 268-281.
4. Manna SK, Gangadharan C, Edupalli D, Raviprakash N, Navneetha T, Mahali S and Thoh M (2011). Ras puts brake on doxorubicin-mediated cell death in p53 expressing cells. *Journal of Biological Chemistry* 286: 7339-7347.
5. Naik US, Gangadharan C, Abbagani K, Nagalla B, Dasari N and Manna SK (2011). A study of nuclear transcription factor-kappa B in childhood autism. *PLoS One* 6: e19488.
6. Thoh M, Babajan B, Raghavendra PB, Sureshkumar C and Manna SK (2011).

- Azadirachtin interacts with retinoic acid receptors and inhibits retinoic acid-mediated biological responses. **Journal of Biological Chemistry** 286: 4690-4702.
7. Fialho AM, Salunkhe P, Manna SK, Mahali S and Chakrabarty AM. Glioblastoma multiforme: Novel therapeutic approaches. **ISRN Neurology** (In press).
 8. Manna SK. Double-edged sword effect of biochanin to inhibit nuclear factor kappaB: Suppression of serine/threonine and tyrosine kinases. **Biochemical Pharmacology** (In press).

LABORATORY OF BACTERIAL GENETICS

Studies on Gene Regulation, Transcription Termination, and Amino Acid and Ion-Transport in *Escherichia coli*

Principal Investigators	J Gowrishankar	Director & Staff Scientist
	Abhijit A Sardesai	Staff Scientist
	R Harinarayanan	Staff Scientist
PhD Students	Syeda A Haneea	Senior Research Fellow (Till Oct. 2011)
	Shivalika Saxena	Senior Research Fellow (Till Sep. 2011)
	Carmelita N Marbaniang	Senior Research Fellow
	L Shanthi	Senior Research Fellow
	Amit Pathania	Senior Research Fellow
	Aanisa Nazir	Senior Research Fellow
	Amar Deep Lakra	Junior Research Fellow
	Rajvardhan M Kamble	Junior Research Fellow
	Suchitra Upreti	Junior Research Fellow (Since Jul. 2011)
	Nalini Raghunathan	Junior Research Fellow (Since Feb. 2012)
Other Members	VK Mishra	Staff Scientist
	K Anupama	Staff Scientist
	J Krishna Leela	Technical Officer III
	TS Shaffiqu	Technical Officer I
	Vimala Allada	Project Associate
	P Hima Bindu	Project Associate
	Vijay Gunasekaran	CDFD-IKP Fellow
	Noor Md Shaik	CDFD-IKP Fellow

Objectives

1. To study the ArgP regulon and the mechanism of ArgP-mediated transcriptional regulation of the arginine exporter ArgO;
2. To test the model of and mechanisms mediating R-loop formation from nascent untranslated transcripts;
3. To investigate an unusual phenomenon of K⁺ toxicity in *hns trx* double mutant strains;
4. To determine the role of *thiI* in *E. coli* osmoadaptation;
5. To understand biological functions of the stringent response factors (p)ppGpp/DksA;
6. To delineate roles of transketolase function in *E. coli* physiology.

Summary of work done until the beginning of this reporting year (upto March 31, 2011)

The work undertaken in earlier years on each of the objectives has been summarized in the first parts of the corresponding descriptions below.

Work undertaken in the current reporting year (April 1, 2011 - March 31, 2012)

1. Studies on Rho-dependent transcription-termination and the R-loop model

Cotranscriptional occupancy of mRNA by ribosomes, that is, transcription-translation coupling, is observed in *Bacteria*, *Archaea* and some eukaryotic negative-strand RNA viruses, and mechanisms exist in them to terminate the synthesis of transcripts that are not simultaneously translated. In *E. coli*, this process is referred to as Rho-dependent transcription termination.

In work from this laboratory that was described in the earlier reports, we had shown that a newly isolated missense mutation in *nusA* (-R258C) confers a phenotype of defective Rho-dependent transcription termination in *E. coli* just as do certain missense mutations in *rho* or *nusG*. The H-NS family of nucleoid proteins were also shown to modulate the efficiency of Rho-dependent termination, which was sought to be explained by a new model invoking

a novel role for the polymeric architectural scaffold formed on DNA by these proteins. Several phenotypes in the *nusG*, *rho*, and *nusA* missense mutants were also interpreted as evidence in support of the increased occurrence (by re-annealing to DNA of nascent untranslated transcripts) of RNA-DNA hybrids or R-loops in them. These phenotypes include synthetic lethality with deficiencies of R-loop removing enzymes RNase H1 or RecG, increased copy number of plasmids (such as pACYC184 or pUC19) that are R-loop dependent for replication, and suppression of lethality associated with RNase E deficiency by the *rho/nusG/nusA* mutations through the bypass mechanism of R-loop mediated RNA degradation.

In the current reporting year, two separate lines of evidence have been obtained to validate the R-loop model and to establish that Rho-dependent transcription termination is essential for genome-wide R-loop prevention. The first was the demonstration by a bisulphite sensitivity assay of increased R-loop occurrence in a *nusG* missense mutant, and the second was the finding of suppression of $\Delta\rho$ and $\Delta nusG$ lethality by ectopic R-loop helicase expression, which are further described below.

R-loop occurrence *in vivo* can be demonstrated by an assay for increased sensitivity of C to T conversions on the displaced DNA single strand upon exposure *in vitro* to sodium bisulphite. Total nucleic acids isolated without denaturation from an MG1655 derivative, as well as from its isogenic *nusG* (-G146D) missense mutant defective for Rho-dependent termination, were treated with bisulphite and subjected to whole-genome next-generation resequencing. The complete population of sequence reads (each ~50 bases long) was first mapped to the MG1655 reference genome sequence yielding >100 X -coverage, and those that remained unmapped were then sequentially mapped to two modified MG1655 upper strand genome sequences, the first bearing conversions of all C residues to T's and the second of all G's to A's. It was expected that DNA segments which had suffered clustered C-to-T changes would generate reads that remain unmapped to the native reference sequence, but instead would map to the C-to-T or G-to-A converted reference sequences depending upon whether the bisulphite mutagenesis had targeted the upper or lower genomic strands, respectively.

Upon mapping of reads to the native reference genome, we found that >90% of cells in the *nusG* mutant culture are deleted for the cryptic prophage *rac*. Since another *nusG*-G146D strain GJ3107 in our lab stock was also shown to have suffered a spontaneous excision of *rac*, we conclude that there exists a positive selection for loss of *rac* in presence of this mutation.

The aggregate number of reads mapping to the two converted reference genomes taken together (and expressed as a ratio of those mapping to the native reference genome) was approximately three-fold higher in the *nusG* mutant (20%) compared to that in the wild-type strain (7.5%), in accord with the genetic evidence for increased occurrence of R-loops in the former. The numbers of reads (per kb) mapping to the C-to-T and G-to-A converted reference genomes for each of the >4300 genes were then determined, and are referred to as N_{upper} and N_{lower} , respectively. With increasing algebraic values of $[N_{upper} - N_{lower}]$ in the *nusG* strain, genes transcribed in clockwise or '+' (relative to those in counterclockwise or '-') orientation were progressively over-represented across the genome (that is, as one moves from left to right in the bar chart, for example, of genes in the counterclockwise replication arm shown in Figure 1), and *vice versa*. These results indicate that it is the non-template strand of transcription which exhibits preferential bisulphite reactivity across the vast majority of genes. At the same time, highly expressed genes such as those encoding proteins of the transcription-translation apparatus were not overly bisulphite-sensitive, which suggests that bisulphite was not simply targeting the unpaired non-template strand within an RNA polymerase transcription bubble.

An effect of replication fork direction on the read numbers mapping to the converted reference genomes was also detected from the frequency distribution data for the *nusG* mutant, with the value of $[N_{upper} - N_{lower}]$ being higher on average by around 300 for each of the genes in both '+' and '-' orientation on the clockwise chromosomal replication arm (from 86 min through 100/0 min to 32 min of the *E. coli* map) relative to that for genes in corresponding orientation on the counterclockwise replication arm (from 82 min to 36 min). We surmise that these features reflect the bisulphite sensitivity of single-stranded regions on the lagging-strand template in replication, which will be expected to contribute to higher values of N_{upper} and N_{lower} on the clockwise and counterclockwise replication arms, respectively.

The patterns of bisulphite reactivity in the wild-type strain were identical to those in its *nusG* derivative with regard both to the relative sensitivities of, and to strand-biasness in, the individual genes ($r=0.87$ and 0.93 , respectively). Thus, the differences between parent and mutant strains were only quantitative and not qualitative, suggesting that R-loops also occur at lower frequencies in wild-type *E. coli*, including presumably from promiscuously initiated and untranslated transcripts across the genome. Consistent with this interpretation, the magnitude of global bisulphite sensitivity of a nucleic acid preparation from the *nusG* derivative in which RNase H was overexpressed, as assessed by the proportion of reads mapping to the two converted reference genomes *versus* those to the native reference genome, was 80% lower even than that in the untreated wild-type strain.

Around 77 single- and multi-gene loci or clusters of increased bisulphite sensitivity were identified, each possessing at least one gene that scored above the 97th percentile for N_{upper} or N_{lower} values for genes in '+' and '-' orientations on the two replication arms of the wild-type and *nusG* strains. The clusters were distributed non-randomly, with disproportionately increased representation for genes within 10 min (~0.5 Mbp) on either side of the chromosomal replication origin (Figure 2). In a majority of the clusters, the regions of heightened bisulphite sensitivity were confined to just one of the two DNA strands but included genes in both orientations or in large operons, reflecting the effects of polarity, antisense transcription or readthrough across normal termination signals which are three of the postulated targets of Rho-

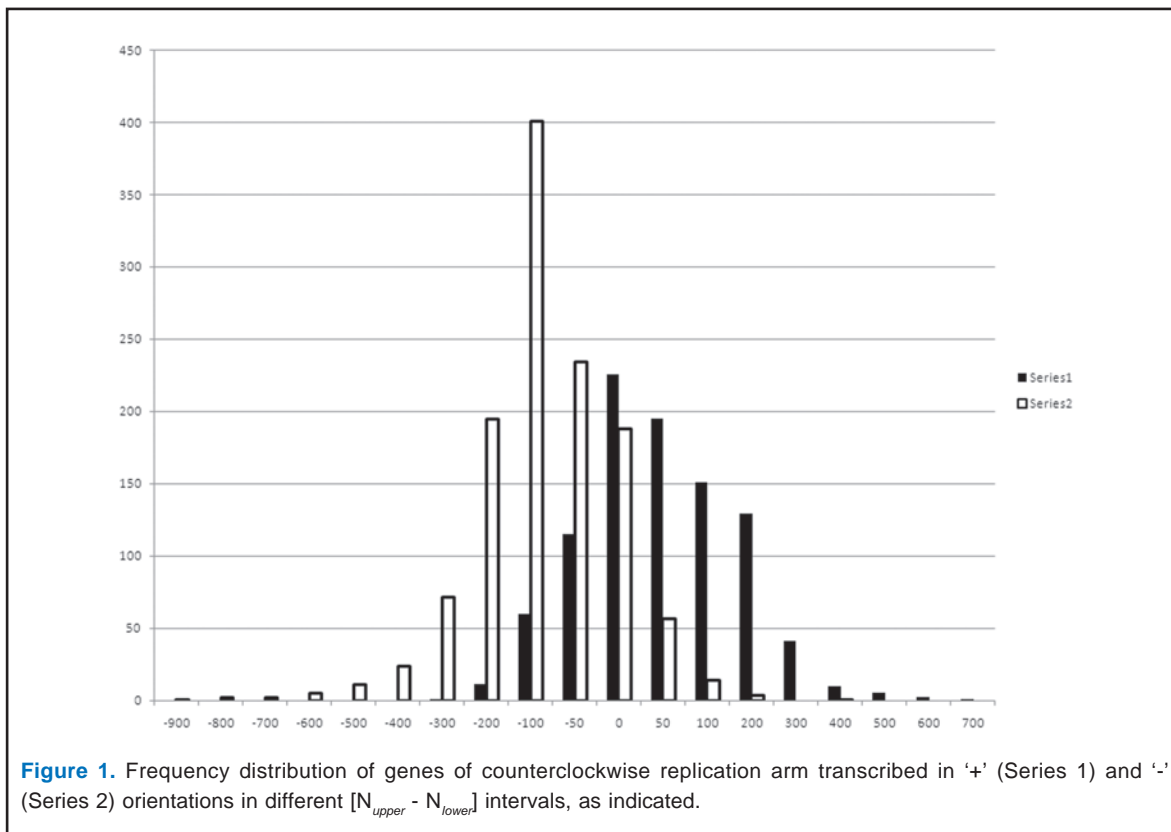

In the wild-type as well as *nusG* strains, increased bisulphite sensitivity of individual genes was moderately correlated with increased content of G nucleotides on the non-template strand, which can be explained by the increased propensity for R-loops from G-rich transcripts. A strong inverse correlation was also detected between bisulphite sensitivity and the content of A-nucleotide residues on the non-template strand.

dependent termination. About fifty genes in the clusters have also earlier been identified, by another less direct method, to be close to putative targets of Rho-dependent termination. Likewise, several clusters were found to overlap with, or reside adjacent to, the horizontally acquired non-essential gene regions that were earlier proposed to be silenced by Rho-dependent termination.

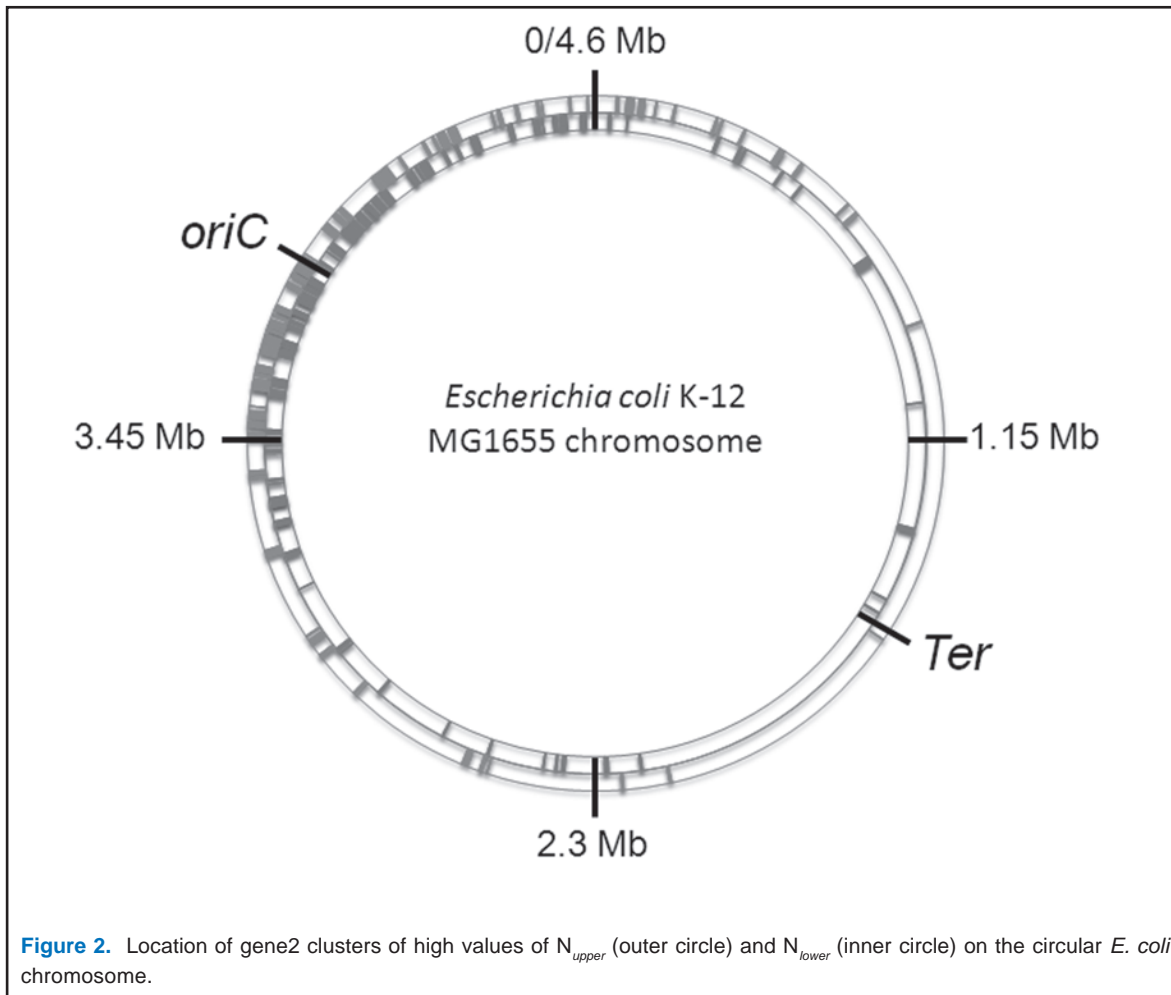

Figure 2. Location of gene2 clusters of high values of N_{upper} (outer circle) and N_{lower} (inner circle) on the circular *E. coli* chromosome.

The analysis of the genome sequencing data from this experiments has therefore established that in a *nusG* mutant defective for Rho-dependent termination, there is an increased genome-wide sensitivity to bisulphite indicative of a much increased frequency of R-loops, since it is also suppressed upon RNase H overexpression.

The second set of experiments to test the R-loop model was based on the fact that each of the proteins Rho, NusG and NusA involved in Rho-dependent termination is essential for viability of the *E. coli* wild-type strain MG1655; NusG and NusA are also involved in antitermination of the naturally untranslated transcripts of ribosomal RNA operons, as well as in regulating the rates of transcription elongation of all genes. In light of our model that defective Rho-dependent termination is associated with increased occurrence of toxic R-loops, we tested whether ectopic expression of a phage T4-encoded R-loop helicase UvsW would rescue the lethality of Δrho , $\Delta nusG$, and $\Delta nusA$ mutants. Since UvsW also negatively regulates

copy number of many commonly used plasmids, its graded expression in cells was achieved from a single copy chromosomal P_{tac} -UvsW construct (by addition of varying concentrations of the inducer IPTG), and control derivatives similarly expressed a UvsW variant (-K141R) that is inactive for its ATPase and helicase functions. Viability of the Δrho strains (and likewise of $\Delta nusG$ or $\Delta nusA$, see below) was assessed by the ability of their derivatives carrying the cognate single-copy-number *rho*⁺ (or *nusG*⁺ or *nusA*⁺) *lacZ*⁺ plasmid to yield spontaneous plasmid-free segregants, which could be distinguished by blue-white screening of colonies on plates supplemented with Xgal.

It has been reported that NusG and NusA, but not Rho, are dispensable in MDS42, an MG1655 derivative with a 14% reduced genome content because of engineered deletions of several horizontally acquired cryptic prophages and insertion elements, and that NusG is also dispensable in MG1655 deleted for just the *rac* prophage; accordingly, our initial experiments were

done in a Δlac derivative of MDS42. With either of two deletion ρ alleles, MDS42 derivatives with P_{tac} -UvsW, but not P_{tac} -UvsW-K141R, were viable on glucose minimal medium supplemented with $\geq 25 \mu\text{M}$ IPTG; both strains were inviable on rich (LB) medium at any IPTG concentration. The ρ^+ P_{tac} -UvsW derivative was also killed on LB medium with $\geq 50 \mu\text{M}$ IPTG, indicative presumably of R-loop helicase toxicity through unwinding of the RNA primers for Okazaki fragment synthesis; indeed, UvsW overexpression (elicited with $500 \mu\text{M}$ IPTG on minimal medium) was more toxic in the ρ^+ than $\Delta\rho$ strain despite the levels of UvsW being similar in both, suggestive of a protective titration effect by genome-wide prevalence of R-loops in the latter (Figure 3). Interestingly in MG1655 $\Delta\rho$ as well, UvsW expression from P_{tac} conferred viability, but again only so in minimal medium (with an optimal growth rate of 0.29 h^{-1} , that is, 45% of that in MG1655).

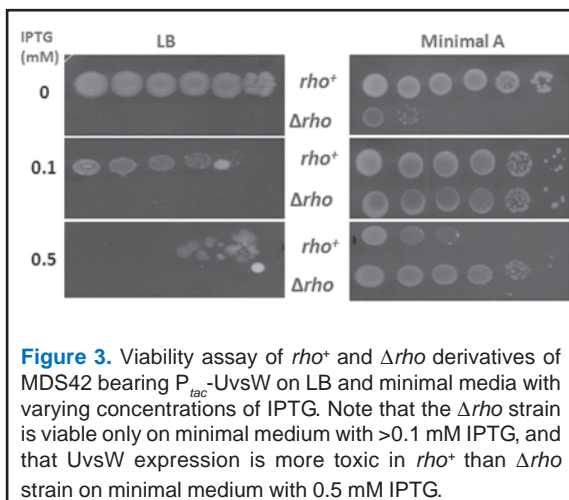

Figure 3. Viability assay of ρ^+ and $\Delta\rho$ derivatives of MDS42 bearing P_{tac} -UvsW on LB and minimal media with varying concentrations of IPTG. Note that the $\Delta\rho$ strain is viable only on minimal medium with $>0.1 \text{ mM}$ IPTG, and that UvsW expression is more toxic in ρ^+ than $\Delta\rho$ strain on minimal medium with 0.5 mM IPTG.

As with $\Delta\rho$, lethality conferred by $\Delta nusG$ (three alleles tested, including one encoding deletion of only the C-terminal domain) in MG1655 was rescued by UvsW but not UvsW-K141R; in these cases, viability was restored by UvsW on both rich and minimal media (with optimal growth rates of 0.34 h^{-1} and 0.21 h^{-1} , respectively). In MDS42 $\Delta nusG$, which by itself was only viable (and very poorly so) in rich medium, UvsW expression conferred robust growth even on defined media. The double mutant $\Delta\rho \Delta nusG$ derivative of MDS42 but not MG1655 was viable with UvsW on minimal medium. Overexpression (from P_{ara}) of neither RecG nor RNase H1 rescued MDS42 $\Delta\rho$ or MG1655 $\Delta nusG$ lethalties.

For $nusA$, four different deletion alleles tested were each lethal in both MG1655 and MDS42 but, unlike

with $\Delta\rho$ or $\Delta nusG$, none could be rescued on any medium by expression of UvsW.

These results allow us to conclude that the essentiality of Rho and NusG is related solely to their function in reducing the pervasive occurrence of R-loops from nascent untranslated transcripts across the genome (and the consequent blockage of replication fork progression); the fact that $\Delta nusA$ is not rescued by UvsW indicates that NusA has essential role(s) in addition to that in Rho-dependent termination.

The rescue by UvsW of $\Delta\rho$ lethality only in minimal but not rich media would suggest that rectification of the problem caused by residual R-loops in these cells requires sufficient time to be available between the passage of successive replication forks across them. A mutant RNA polymerase RpoB*35 (-H1244Q) which is less prone to stalling and backtracking and confers tolerance to Rho inhibition, did restore viability to MDS42 $\Delta\rho$ in minimal medium but (as also reported earlier) was unable to do so on rich medium; RpoB*35 could not rescue MG1655 $\Delta nusG$ nor the $\Delta\rho$ derivatives of MG1655 or MG1655 Δrac . Of two other RpoB variants that suppress phenotypes associated with Rho-dependent termination, RpoB101 (-Q513L) but not RpoB8 (-513P) conferred viability to MDS42 $\Delta\rho$ on minimal medium. The combined presence of RpoB*35 and UvsW restored viability even on rich media to the $\Delta\rho$ derivatives of MDS42 and MG1655 Δrac but not of MG1655. UvsW has been reported to function as a junction helicase for restoration of collapsed replication forks, and it is possible that this activity may additionally contribute in the rescue of $\Delta\rho$ and $\Delta nusG$ lethality.

Thus, our data suggest that the need for efficient Rho-dependent termination is reduced progressively and independently (i) from MG1655 through its Δrac derivative to MDS42, (ii) upon reduction in growth rate, (iii) in presence of RpoB*35, and (iv) more so upon UvsW expression; concomitantly, Rho-dependent termination is increasingly compromised through the following strains: missense mutants of $nusA$, ρ or $nusG$; $\Delta nusG$; and $\Delta\rho$. Mechanistically, the increased prevalence of R-loops in Rho-compromised strains may reflect either their reduced removal or, perhaps more likely, their increased generation by re-annealing of nascent transcripts to upstream DNA.

Finally, R-loops have been shown to occur in yeast, chicken and mammalian cells from nascent RNAs

that fail to undergo cotranscriptional splicing, polyadenylation or export, leading to replication fork blockage and loss of genome integrity. This is reminiscent of the bacterial situation in which R-loops occur from transcripts that fail to be cotranscriptionally engaged by ribosomes. Furthermore in yeast and human cells, loss of the Sen-1/senataxin helicase is associated with both increased R-loops and defective transcription termination. Thus, cotranscriptional engagement of RNA by different proteins is emerging as a general mechanism for R-loop prevention in prokaryotes and eukaryotes.

2. ArgP regulon and mechanism of ArgO exporter function

- a. Earlier work from this laboratory had identified ArgO as an arginine (Arg) exporter in *E. coli* whose transcription is under the control of a LysR-type transcriptional regulator ArgP such that it is induced by Arg and repressed by Lys. Whereas Arg-mediated activation of *argO* transcription is effected by RNA polymerase recruitment to the *argO* promoter, the Lys-mediated inactivation of *argO* transcription has been shown to operate at the last stage of promoter clearance, making this the first example of reversible environmental regulation operating at the promoter escape step of bacterial transcription. Dominant gain-of-function mutations in *argP* (*argP^d*) were also identified that confer a phenotype of constitutively elevated *argO* transcription and abolition of the inactivating effects of Lys supplementation.

In the work reported last year, we had described the identification, through both promoter-lac fusion and electrophoretic mobility shift assay (EMSA) studies, of several additional genes regulated by ArgP, including *dapB*, *gdhA*, *lysP*, *lysC*, *asd*, *lysA* and *dapD*. All were repressed upon Lys supplementation, and *in vitro* studies demonstrated that ArgP binds to the corresponding regulatory regions in a Lys-sensitive manner (in contrast to the situation with *argO*, where ArgP binding was Lys-insensitive). ArgP was also shown to bind to regulatory regions of other genes such as *dnaA*, *nrdA*, and *argT* but without concomitant effect on their expression *in vivo*, indicating that ArgP is a non-canonical transcriptional regulator that mediates all Lys-liganded repression in *E. coli*.

In the current year, we have examined the features of transcriptional cross-regulation *in*

vivo between ArgP-*argO* of *E. coli* (Gram-negative) and their orthologs LysG-*lysE* of *Corynebacterium glutamicum* (Gram-positive). In *C. glutamicum*, LysE is an Arg and Lys exporter that is transcriptionally activated by LysG in presence of Arg, Lys or histidine. Our results indicate that LysG can activate *lysE-lac* expression in *E. coli* (in presence of Lys or histidine), thereby recapitulating, at least qualitatively, the regulation in *C. glutamicum* itself of *lysE* by LysG; however, neither ArgP nor LysG could cross-activate *lysE-lac* or *argO-lac*, respectively. On the other hand, some of the constitutive ArgP^d variants such as S94L, P274S, and P108S, were able to cross-activate *lysE-lac* in *E. coli*.

Our results therefore demonstrate for the first time that a transcription factor from a Gram-positive bacterium is able to engage appropriately with RNA polymerase of a Gram-negative bacterium for recruitment to the former's cognate target site, and that the RNA polymerase is then competent for successful recognition of and transcription initiation from the Gram-positive promoter. Furthermore, substitution of a single amino acid at any one of several sites in ArgP generates variants that have now acquired an additional capability to activate a distantly orthologous target.

Interestingly, in the absence of any co-effector, *lysE-lac* expression in *E. coli* was markedly lower when LysG was induced than in the control strain carrying vector alone. This observation suggests that non-liganded LysG represses *lysE* perhaps by steric inhibition of basal RNAP binding to the promoter, analogous to that classically described for AraC at the *araBAD* promoter in *E. coli*.

In EMSA experiments, the ArgP^d proteins differed from native ArgP in their binding to *argO* which could be attributed to differences in DNA bending induced by these proteins (less bending with ArgP^d). At *lysE* on the other hand, the ArgP^d proteins exhibited higher binding affinity than did native ArgP. We believe that the differences observed in binding *in vitro* may be causally related to the differences in regulation observed *in vivo*.

- b. To understand the mechanism of Arg and canavanine export through ArgO, we had earlier reported the results of mutagenesis studies of ArgO identifying amino acid residues that are

critical for ArgO function. The amino acid substitutions G20C, Q22R, V118E, D128Y, S156F and F160S, individually produced ArgO variants with impaired biological activity, but were produced at levels comparable to wild type ArgO. The G20C and Q22R substitutions are located in the putative first transmembrane segment, V118E and D128Y substitutions in the fourth and S156F and F160S substitutions in the fifth transmembrane (TM) segment. The above-mentioned substitutions alter residues that are conserved in ArgO orthologs. To test whether the loss of ArgO activity in these variants might occur due to alterations in normally occurring inter/intrahelical interactions we have searched for second site suppressor mutations that suppress the phenotype of impaired ArgO function associated with the above-mentioned primary mutations. We have obtained three independent second site suppressors of three primary ArgO mutants bearing the amino acid substitutions V118E, S156F and F160S. The suppressor mutations obtained herein are taken as a diagnostic for the existence of putative functional interhelical interactions occurring between TM1-TM5, TM2-TM4 and TM2-TM5. In this regard, we are currently employing alternate methods to obtain an independent line of evidence regarding the existence of interhelical interactions in ArgO. In addition, we had earlier performed an analysis of the topological disposition of ArgO in the inner membrane of *E. coli* using the alkaline phosphatase gene fusion technology, and our studies have suggested that both the N and C termini of ArgO are localized to the periplasm, and that the amino acid residues critical for ArgO activity identified herein are located in the transmembrane segments of ArgO. To obtain an independent correlate of the topology of ArgO we have initiated cysteine accessibility studies on ArgO. For this purpose we have generated an ArgO variant lacking cysteine residues (Cysless-ArgO; ArgO_{CYL}) that retains biological ArgO activity and is expressed at levels comparable to ArgO. In the backbone of ArgO_{CYL} we have obtained variants each bearing a single cysteine residue located at different positions in ArgO, retaining functional ArgO activity and near normal expression levels. Cysteine accessibility studies with the sulfhydryl reagent malPEG are being performed.

- c. In *E. coli*, ArgO represents the only example of a solute exporter involved in mediating export of a basic amino acid, Arg. Furthermore, so far there is no evidence which suggests that ArgO can mediate export of Lys, a feature that its ortholog LysE from *C. glutamicum* possesses. In order to identify novel genes whose products may promote export of Arg or Lys we have isolated plasmid clones from a genomic library cloned on a medium copy number plasmid, whose presence suppresses the canavanine sensitive (Can^s) phenotype of a strain lacking ArgO. Our studies have shown that canavanine resistance is mediated by the presence in the plasmid inserts of a novel ORF *ybjE*, predicted to encode an inner membrane protein. Elimination of YbjE modestly exacerbated the Can^s phenotype of an *argO* null mutant but its deficiency on its own does not alter the Can^s phenotype of a wild type parent. On the other hand, growth of a *ybjE* but not an *argO* null mutant was rendered hypersensitive to the toxic analogue of Lys, thialysine. Furthermore, the *ybjE* mutant was impaired for growth in media containing lysyl but not arginyl dipeptides. These studies suggest that YbjE mediates export of Lys. It is speculated that Lys export mediated by YbjE may interfere in uptake of Canavanine by the Arg permease thus mediating an apparent enhancement in canavanine resistance phenotype due to increased *ybjE* gene dosage. *ybjE* has been renamed as *lysO* and currently we are examining its regulation and properties of Lys export mediated by LysO.

3. Potassium toxicity of *E. coli* mutants

The origins of the project lie in our observation that an *E. coli* strain doubly defective for thioredoxin 1 and thioredoxin reductase (*trxA* or *trxB* respectively) and the nucleoid protein H-NS is growth inhibited by external concentrations (≥ 40 mM) of the essential cellular cation K⁺. To understand the physiological defect that renders the TH (*trxA hns*; *trxB hns*) strain K⁺ sensitive, previously we have reported that the K⁺ sensitive phenotype of the TH strain occurs because of the presence of elevated cytoplasmic ppGpp level contributed by the resident *spoT1* allele and is dependent on activity of the stationary phase sigma factor RpoS. Our genetic studies have also shown that the *trx* mutations may lead to reduced levels of non-coding RNA *oxyS* by altering the redox state of the OxyR protein. Accordingly *oxyS hns* or *oxyR hns* mutants

are rendered K⁺ sensitive. We have also reported results of extensive suppressor studies on the TH strain and have isolated mutations in *rpoS*, *yajC*, *cspC*, *acp*, *fabF*, *glpR*, *ycgO*, *ahpC* that suppress the K⁺ sensitivity of the TH strain. Furthermore, we have found that the presence of the *tetA* gene of the plasmid pBR322 and the *oxyR2*, *spoT*⁻ alleles also exert suppressive effects. In this year, we have further derived genetic interrelationships between the various suppressor mutations and found that one category of suppressor mutations (*acp*, *glpR*, *yajC* and *spoT*⁻) exerted their suppressive effects by mediating a reduction in cellular ppGpp levels. On the other hand, mutations in *cspC* (and *rpoS*) impaired the levels of RpoS without affecting cellular ppGpp levels. Mutations in *ycgO*, *fabF* and the presence of pBR322 exerted their suppressive effects in an RpoS and ppGpp independent manner. Estimates of K⁺ content in the TH strain showed that the *trx hns* mutations contributed additively to a 3 fold increase in cellular K⁺ content in a high extracellular K⁺ environment compared to the parental strain. Furthermore, the K⁺ sensitivity caused by the *trx hns* mutations persisted in strains lacking known K⁺ uptake systems. We have utilized magnitudes of expression of a reporter of cellular K⁺ content, that is a *kdp-lac* fusion, as an indirect gauge of suppressor action on cellular K⁺ levels, and have found that in general the suppressor mutations may afford protection against the lethal build up of cellular K⁺ in the TH strain by directly or indirectly mediating reduction in cellular K⁺ levels. Our studies indicate that the *trx* (*oxyS*), *spoT1* and the *hns* mutations may collectively unveil a novel cryptic RpoS dependent K⁺ uptake pathway incipient in media of high extracellular K⁺.

In *E. coli* the phosphotransferase system (PTS) constitutes a transport system for uptake of carbohydrates wherein transport of the incoming sugar is coupled to its phosphorylation. *E. coli* possess a paralogous PTS comprising the proteins PtsP, PtsO and PtsN with PEP dependent phosphotransfer occurring from PtsP to PtsN via PtsO. Previously we have reported that the K⁺ sensitivity of the TH strain is suppressed by mutations in *ptsP* and *ptsO* and occurs without alterations in cellular ppGpp and RpoS levels. Suppression by the *ptsP* mutation requires the presence of *ptsN* that encodes EII^{Ntr}, implicating a role for dephospho-PtsN in mediating suppression. In this year, we found that the *ptsN* mutant consistent with reports in literature was K⁺ sensitive and like the TH strain displayed SpoT1 dependence. The K⁺ sensitive phenotype of a *ptsN*

mutant was suppressed by the *tetA* gene, and by mutations in *ycgO*, *fabF*, *yajC* and *glpR* but not by removal of RpoS (or other suppressor mutations like *cspC* or *oxyR2* that reduce RpoS levels). We found a 2-3 fold increase in cellular K⁺ content in the *ptsN* mutant compared to the parent strain, and suppression of the K⁺ sensitivity of the *ptsN* mutant by the above-mentioned suppressor mutants was associated with altered (elevated) expression of a *kdp-lac* fusion, suggesting that similar to that seen for the TH strain in general the suppressor mutations may protect a *ptsN* mutant from the lethal build-up of cytoplasmic K⁺ by mediating its reduction. Our studies suggest that the physiological defects in the *trx hns* and the *ptsN* mutants may represent two types of perturbations acting in mechanistically distinct ways on a single K⁺ translocating protein, to unfetter its activity. Currently we are testing the effects of the various suppressors of the K⁺ sensitivity of TH strain and the *ptsN* mutant on cellular K⁺ levels.

4. Role of *thil* in *E. coli* osmoadaptation

Bacteria possess genetic determinants that enable them to adapt to a variety of abiotic stresses, thus endowing them with abilities to inhabit a vast range of ecological niches. In this regard, the ability to adapt to changes in the osmolarity of the external environment is one that is important for the growth and survival of bacteria, and for this purpose they bear mechanisms that allow for their adaptation to environments of varying osmolarity. In a study aimed at identifying additional gene products involved in the process of osmoregulation we employed a transposon mutagenesis approach and obtained *E. coli* mutants that were rendered osmosensitive for growth in media of high osmolarity. In some mutants transposon insertions causal to the osmosensitive phenotype were obtained in genes whose products were hitherto not known to participate in bacterial osmoregulatory processes. Amongst them some mutants bore transposon insertions in *thil* that encodes a bifunctional enzyme participating in thiamine biosynthesis at the step of formation of the thiazole moiety and in addition is responsible for the 4-thiouridine (s⁴U), modification in tRNA. In order to understand the physiological basis for the osmosensitive (O^S) phenotype associated with the *thil* null mutants, we have obtained multiple lines of evidence which suggest that the O^S phenotype of a *thil* mutant is not related to its role in thiamine biosynthesis. First, the O^S phenotype

persists in presence of exogenous thiamine and mutations in genes encoding other components of the thiamine biosynthesis pathway do not yield a similar phenotype. Second, consistent with recent reports in literature we find that heterologous production of a polypeptide containing the last 106 amino acids comprising the rhodanase domain of Thil rescues the thiamine auxotrophy of a *thil* mutant but does not alter its O^s phenotype. On the other hand, heterologous production of the Thil variants Thil_{D189A} and Thil_{K321M} bearing amino acid substitutions in residues critical for the generation of s⁴U modification in tRNA, render a *thil* mutant prototrophic for thiamine but do not alter its O^s phenotype. These studies suggest that of the two functions of Thil, its role in generating the s⁴U in tRNA is the one that is required for osmoadaptation.

In a parallel study we have isolated a collection of spontaneous mutants that bear extragenic suppressor mutations that suppress the O^s phenotype of a *thil* mutant. We have located, by performing whole genome sequencing of two suppressor strains, using the ABI SOLiD™ 3 plus platform, the genetic lesions that render the suppressor strains osmotolerant (O^T). Comparative analyses allowed for the detection of two distinct base alterations in the genome sequences of the two suppressor strains that were causal to their O^T phenotypes. Both strains bore base transversions located in the coding and in the 5' UTR of the *pnp*, the gene encoding the enzyme polynucleotide phosphorylase, that is a component of the mRNA degradosome complex. Further genetic studies showed that the two lesions in the *pnp* locus of the suppressor strains were recessive and that a defined knockout allele of *pnp* also suppressed the osmosensitivity of a *thil* null mutant. The endoribonuclease RNaseE and the helicase RhlB are other two components of the mRNA degradosome ensemble and *thil* mutants lacking RNaseE (Rne) or RhlB also displayed O^T phenotypes. To explain why these mutations suppress the O^s phenotype of a *thil* mutant strain, we are testing for the possibility that in the *thil* mutant elimination of Pnp (or Rne/RhlB) leads to stabilization of an mRNA(s) and the elevated levels of the cognate protein(s) mediate osmotolerance. Since the O^s phenotype of the *thil* mutant correlates with a loss of s⁴U generating capacity of Thil, the possibility that its suppression by mutations in the components of the mRNA degradosome may occur by unmasking of a cryptic s⁴U generation pathway in the suppressor mutant backgrounds is also being tested.

5. (p)ppGpp/DksA regulated functions in *E. coli*

In work reported last year, a synthetic growth defect arising from the absence of ribosome rescue/protein tagging (trans-translation machinery) in strains lacking ppGpp (ppGpp⁰) was genetically characterized. Genetic evidence suggested that the speed of RNA polymerase could be an important contributor to the phenotype.

In the current year, we looked at the contribution of the different steps in the process of ribosome rescue/protein tagging to the synthetic lethal phenotype seen in the absence of ppGpp by using specific mutant *ssrA* alleles. We tested the following plasmid borne *ssrA* alleles for their ability to rescue synthetic lethality (i) wild-type *ssrA*, that is, *ssrA*⁺ (ii) an allele which rescues ribosomes but does not add the degradation tag to the polypeptide chain (*ssrA*⁰); (iii) an allele that rescues ribosomes but adds a defective tag (resistant to the protease machinery) to the polypeptide chain (*ssrA*-DD) and (iv) a base pair alteration that fails to charge *ssrA* with alanine leading to the absence of ribosome rescue and addition of degradation tag (*ssrA*-UG). We find that the *ssrA*⁰ allele is capable of suppressing the synthetic lethality almost at par with that of wild-type *ssrA* while *ssrA*-DD and *ssrA*-UG do not confer suppression. The results indicate that facilitation of the release of stalled ribosomes from the mRNA is important for the growth of ppGpp⁰ strain. The *ssrA*-DD allele has been shown to cause the accumulation of protein *in vivo* due to the addition of protease resistant tag to proteins; however the kinetics of ribosome release by this allele has not been addressed. If ribosome release is unaffected in the *ssrA*-DD allele then the results indicate that accumulation of protease resistant peptides could confer growth defect in the ppGpp⁰ strain. It has been reported that the trans-translation machinery is also involved in the degradation of the released mRNA. The *ssrA* alleles described above have not been characterized for their role in mRNA degradation. The role of impaired mRNA degradation in the synthetic growth defect will be studied.

Given that transcription is coupled to translation in bacteria, recent reports show that the rate of transcription is matched to the rate of translation and that slowing down translation rate results in a matched decrease in rate of transcription elongation. We looked at the effect of increasing concentrations of chloramphenicol (an antibiotic known to decrease translation rate) on the synthetic growth defect of the ppGpp⁰ *ssrA*::cat

strain. We clearly see a positive correlation between suppression of growth defect and concentration of chloramphenicol in the growth media, providing evidence for an association between translation rate and suppression of growth defect.

The role of protein factor DksA that interacts with RNAP through its secondary channel, and shown to work synergistically with ppGpp at a number of promoters, was studied with respect to the synthetic growth phenotype of the ppGpp⁰ *ssrA* mutant. We find that deletion of *dksA* does not confer synthetic growth defect as seen for the ppGpp⁰ strain. On the other hand, the over-expression of DksA, but not a mutant version with substitutions in conserved amino acids thought to be important for modulation of RNAP function can suppress the growth defect.

A spontaneous chromosomal mutation that conferred suppression of the synthetic growth defect was obtained during the course of this study. To identify the mutation(s) responsible for suppression, whole genome sequencing of the mutant strain was carried out and the output compared to the sequence of wild type strain MG1655 deposited at Genbank. Twelve SNPs and one indel were identified. One of the SNPs was in the *rpoB* gene, encoding for the beta-subunit of RNAP, where mutations that suppress phenotypes of ppGpp⁰ strain have been reported. The mutation identified by us, G401A, has not been previously reported, and was shown to be necessary and sufficient to suppress the synthetic growth defect in the ppGpp⁰ *ssrA* double mutant.

6. Genetic analysis of transketolase deficient *E. coli* strain

In work reported previously, isolation and genetic analyses of mutations that suppress growth defect of *tktA tktB* double mutant of *E. coli* in rich medium was described. The study indicated that the following pathways could contribute to the suppression of the growth defect, (i) increased expression of glycerol-3-phosphate kinase (GlpK) in the presence of glycerol-3-phosphate dehydrogenase (GlpD); (ii) decreased synthesis of ribose-5-phosphate through the inactivation of the ribo/deoxyribonucleoside salvage pathway by the *deoB* or *deoD* mutation (iii) increase in NADPH levels through increased levels of the proton translocating pyridine transhydrogenase PntA and PntB. The genetic studies also revealed a surprising link between cellular ribose-5-phosphate

pool and expression of the *glpFKX* genes when studied with the aid of a lacZ protein fusion to the operon's regulatory region. The molecular aspects of the regulation were further studied and are reported below.

The *lacZ* reporter fusion studied revealed that, (i) expression of the operon is about 10-fold lower in the *tktA* mutant compared to a wild type strain; (ii) *deoB* (encoding phosphopentomutase) deletion or a *glpR* (encoding glycerol-3-phosphate repressor) deletion in the transketolase mutant (*tktA*) restores expression close to levels seen in a wild type strain; (iii) ribose supplementation during growth lowers *glp* operon expression in the *tktA deoB* double mutant but not in the *tktA glpR* double mutant to that seen in the *tktA* parent strain. Together the results suggested that ribose-5-phosphate can modulate *glpFKX* expression in the transketolase mutant through GlpR.

We conducted experiments to test if the effect of ribose-5-phosphate on GlpR is direct, that is, it binds to the protein and modulates its DNA-binding activity, or an indirect one wherein cellular GlpR levels are altered through a change in its expression. The idea of direct effect was tested by carrying out EMSA experiments while the indirect effect was tested by monitoring intracellular GlpR levels using a C-terminal HA tagged functional construct of GlpR on the chromosome. The results of the western blotting experiment showed (Figure 4) no significant difference in the intracellular level of GlpR in the transketolase mutant with or without the *deoB* mutation as compared to the wild type strain.

The result of the EMSA experiment, shown in Figure 5, supports the idea of direct interaction of ribose-5-phosphate with GlpR and the modulation of its repressor function. The GlpR protein was tagged with His-6x at the N-terminal and cloned in pHYD3025 a derivative of pET21b. The His6-GlpR construct was shown to be functional *in vivo* and then purified using BL21-DE3 strain and Ni-NTA affinity purification protocol. The results of the EMSA experiment show that glycerol-3-P can destabilize the GlpR-DNA complex as previously reported while ribose-5-P has no effect on the complex. However, from the EMSA experiment it can also be seen that the ability of Glycerol-3-P to destabilize the GlpR-DNA complex is severely compromised in the presence of Ribose-5-P.

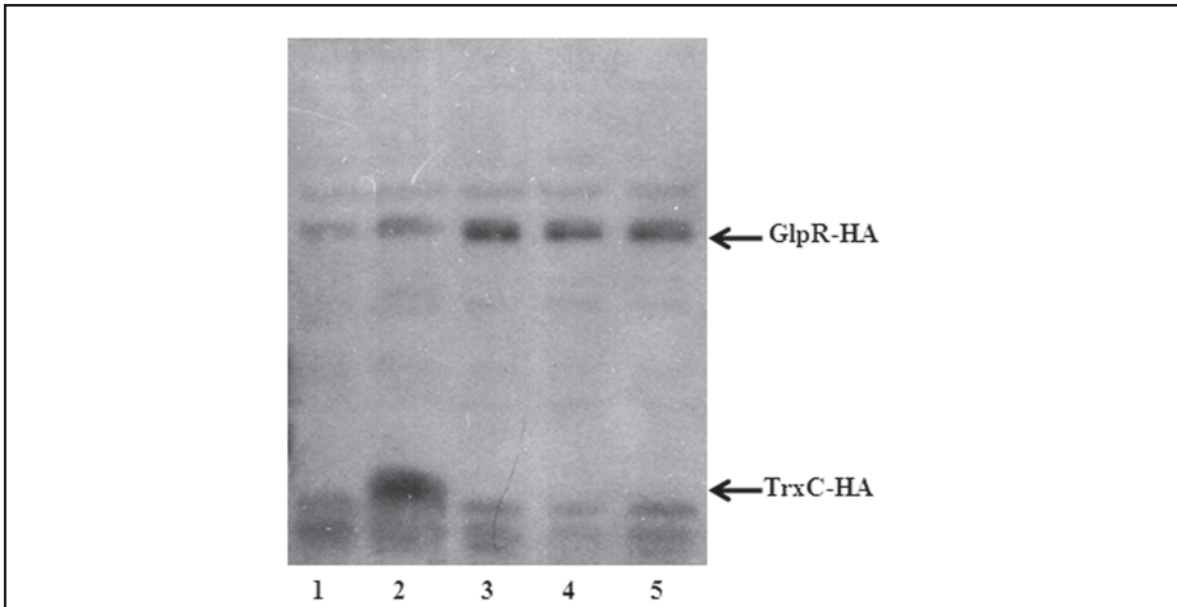

Figure 4. Whole cell lysate prepared from equal number of log phase cells was subjected to SDS-PAGE, the proteins transferred to PVDF membrane following standard procedures and probed using anti-HA antibody. Genotype of the strains used for preparation of whole cell lysate is as follows, Lanes: 1. WT; 2. *trxC-HA*; 3. *glpR-HA*; 4. *tktA glpR-HA*; 5. *tktA deoB glpR-HA*.

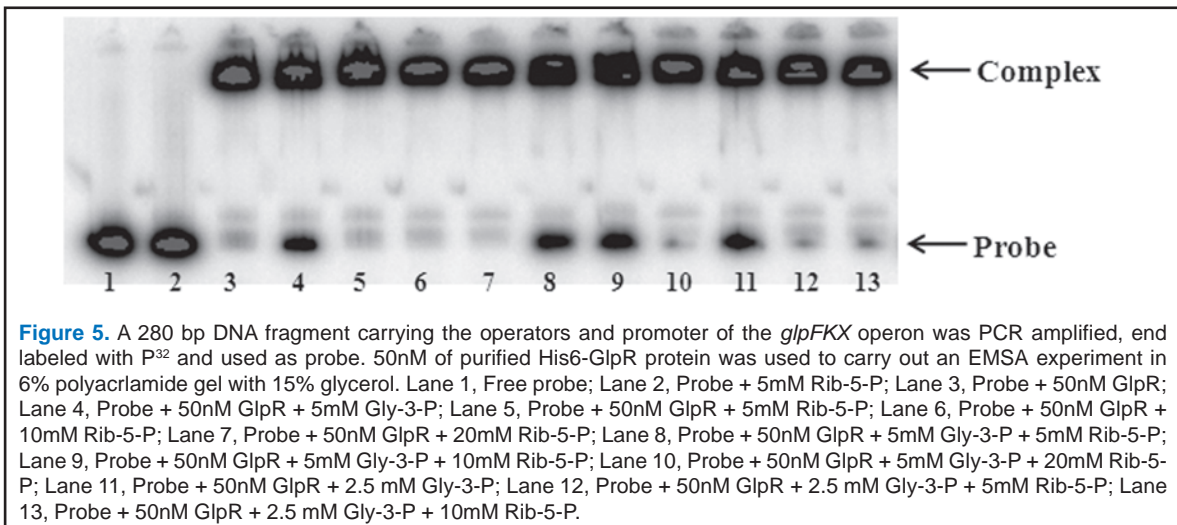

Figure 5. A 280 bp DNA fragment carrying the operators and promoter of the *glpFKX* operon was PCR amplified, end labeled with P^{32} and used as probe. 50nM of purified His6-GlpR protein was used to carry out an EMSA experiment in 6% polyacrylamide gel with 15% glycerol. Lane 1, Free probe; Lane 2, Probe + 5mM Rib-5-P; Lane 3, Probe + 50nM GlpR; Lane 4, Probe + 50nM GlpR + 5mM Gly-3-P; Lane 5, Probe + 50nM GlpR + 5mM Rib-5-P; Lane 6, Probe + 50nM GlpR + 10mM Rib-5-P; Lane 7, Probe + 50nM GlpR + 20mM Rib-5-P; Lane 8, Probe + 50nM GlpR + 5mM Gly-3-P + 5mM Rib-5-P; Lane 9, Probe + 50nM GlpR + 5mM Gly-3-P + 10mM Rib-5-P; Lane 10, Probe + 50nM GlpR + 5mM Gly-3-P + 20mM Rib-5-P; Lane 11, Probe + 50nM GlpR + 2.5 mM Gly-3-P; Lane 12, Probe + 50nM GlpR + 2.5 mM Gly-3-P + 5mM Rib-5-P; Lane 13, Probe + 50nM GlpR + 2.5 mM Gly-3-P + 10mM Rib-5-P.

Glycerol-3-P mediated alleviation of transcriptional repression by GlpR *in vivo* is fairly well documented and our studies have introduced a new player in this regulation, namely, ribose-5-P, and its role in the regulation of the *glp* regulon *in vivo* is being investigated.

Publications

1. Anupama K, Leela JK and Gowrishankar J (2011). Two pathways for RNase E action in *Escherichia coli in vivo* and bypass of its essentiality in mutants defective for Rho-dependent transcription termination. ***Molecular Microbiology*** 82: 1330-1348.
2. Marbaniang CN and Gowrishankar J (2011). Role of ArgP (IciA) in lysine-mediated repression in *Escherichia coli*. ***Journal of Bacteriology*** 193: 5985-5996.
3. Saxena S and Gowrishankar J (2011). Modulation of Rho-dependent transcription termination in *Escherichia coli* by the H-NS family of proteins. ***Journal of Bacteriology*** 193: 3832-3841.
4. Saxena S and Gowrishankar J (2011). Compromised factor-dependent transcription termination in a nusA mutant of *Escherichia coli*: Spectrum of termination efficiencies

generated by perturbations of Rho, NusG, NusA, and H-NS family proteins. *Journal of Bacteriology* 193: 3842-3850.

Other publications

1. Gowrishankar J (2011). Why scientists are missing (Letter). *Down to Earth* (1 May 2011), Pg. 6.
2. Gowrishankar J (2011). Funding of investigator-initiated research projects in India: The case for moving from a proposal-based to a

performance-based evaluation process. *Current Science* 101: 823.

3. Gowrishankar J. What should our policy be for appointing non-Indian citizens as heads of public institutions? *Current Science* (In press).

Patents

1. Gowrishankar J and Nandineni MR. A microbial process for arginine production. Japanese Patent 4836440, issued on 7.10.2011.

LABORATORY OF COMPUTATIONAL BIOLOGY

Computational Studies on Protein Structure, Function and Interactions

Principal Investigator HA Nagarajaram

Staff Scientist

PhD Students Vishal Acharya
Anupam Sinha
H Rachita
Manjari
Suryanarayana Seera

Senior Research Fellow (Till Oct. 2011)
Senior Research Fellow
Senior Research Fellow
Senior Research Fellow
Junior Research Fellow (Since Jan. 2012)

Objectives

Studies on protein-protein interaction networks (PPIN):

1. Analysis of Human-Virus PPI (HU-Vir PPI) network;
2. Studies on spatio-temporal dynamics of human PPIN;
3. Structural and functional characterization of hubs in human PPIN.

Summary of work done until the beginning of this reporting year (upto March 31, 2011)

1. Developed a new SVM-based method called **Hansa** (<http://hansa.cdfd.org.in:8080/>) for prediction of disease causing nsSNPs. This method uses a novel set of discriminatory features that include position specific probability scores calculated using Dirichlet mixture of prior information as well as Gribskov's approach, predicted solvent accessibility and secondary structural features, BLOSUM62 substitution scores and change in free energy changes associated with both wild-type and mutant amino acid residues. A 10-fold cross validation study revealed that **Hansa** yields a prediction accuracy of 83% (at 0.2 FPR) which is more than 10% as compared to the best available method.
2. We undertook a systematic computational analysis of Human-Virus (Hu-Vir) PPIs with special emphasis on the role of intrinsically disordered proteins (IDPs). It was found that about 60% of human proteins interacting with viral proteins are highly disordered whereas only 25% of viral proteins interacting with human proteins are disordered. In the bipartite network of Hu-Vir PPI, it was observed that human proteins either have degree < 60 or > 130 . There

was no preference seen for human IDPs to have either high degree or low degree. Functional enrichment analysis revealed that human IDPs interacting with viral proteins are involved in important functions such as DNA or RNA binding, cell cycle regulation and protein synthesis.

3. Comparative studies on tissue-wise PPINs were carried out. We constructed 79 tissue-wise networks and investigated various topological properties such as degree, betweenness and clustering coefficient of protein products of housekeeping as well as tissue-specific genes. We found that proteins expressed in specific tissues make fewer connections however, with a few exceptions that make tissue-specific hubs. Furthermore, tissue-specific proteins avoid occurring in shortest paths and possess less interconnected partners. In contrast, widely expressed proteins establish most of the interactions and act as global hubs in various tissues. Some of these observations reconfirmed earlier reports.
4. We examined the relation between degree and the number of splice variants of nodes in human PPI network and found a weak positive correlation between the two. We further extended our studies to decipher the relationships between degree and unstructuredness of the nodes. Contrary to previous reports, only a weak positive linear correlation was found between the degree of gene/node and the average unstructuredness of all its splice variants. Studies were also carried out to examine the relationship between the extent of splice variation and the average unstructuredness of protein products. When the ratio of the unstructured variants to the total number of variants in each splice

variation bin was plotted against the bin size, a significant linear positive correlation was observed.

Details of progress made in the current reporting year (April 1, 2011 - March 31, 2012)

Project 1: Analysis of human and virus protein-protein interaction (Hu-Vir PPI) networks

Bridged Hu-Vir Network (BHVN) was constructed by merging Hu-Vir PPI (bipartite network) with the Hu-PPI data. The BHVN was analyzed using the *igraph* package in R in order to identify the viral articulation points. Articulation points are the nodes in the network which connect two previously unconnected components. Such viral articulation points actually add to the complexity of human PPI network. We were able to identify 42 proteins acting as articulation points from 12 viruses belonging to ssRNA and dsDNA viruses. Some of these articulation points were found to be conserved among viruses *i.e.*, similar proteins from related viruses form articulation points when mapped on to Hu-PPI network.

Functional annotation of human proteins connected by viral articulation points was carried out using DAVID Bioinformatics database (Huang *et al.* 2009) with the whole genome used as background for the studies. GO biological processes annotation of human proteins connected to the main network via HIV1 proteins indicated that they are enriched (p -value < 0.05 , > 3 proteins per function) in functions like metabolic pathways, stress response, interspecies interaction and response to stimulus.

Project 2: Studies on spatio-temporal dynamics of human PPI networks

We downloaded protein-protein interaction information available from 8 literature curated databases and manually curated and integrated them into one database. After several steps of manual curation, we could get information for 13773 human proteins making 120046 physical interactions from all the 8 databases.

We used RNAseq data available for 10 tissues and 5 cell lines from Wang *et al.* (2008) and constructed tissue-specific (local) interaction networks. Topological properties of proteins/genes expressed in each tissue were calculated using *igraph-a* package provided by R (<http://www.r-project.org/>) and topologically important nodes were identified tissue-wise with cut off of top 20% (the same was also repeated with different cut-off of 5% and 10%). We then identified hubs and non-hubs in each tissue-specific network and studied their gene expression attributes *i.e.* expression abundance and expression variance which are calculated by taking mean and statistical variance of expression values of the gene across the tissue where it is expressed respectively. When expression abundance and variance of hubs and non-hubs were calculated and plotted (Figure 1), we found that the hubs were generally associated with significantly higher expression abundance and variance than the non-hubs (P value $< 2.2e-16$) which shows that genes encoding hubs proteins are expressed in more number of copies and are more differentially expressed than non-hubs.

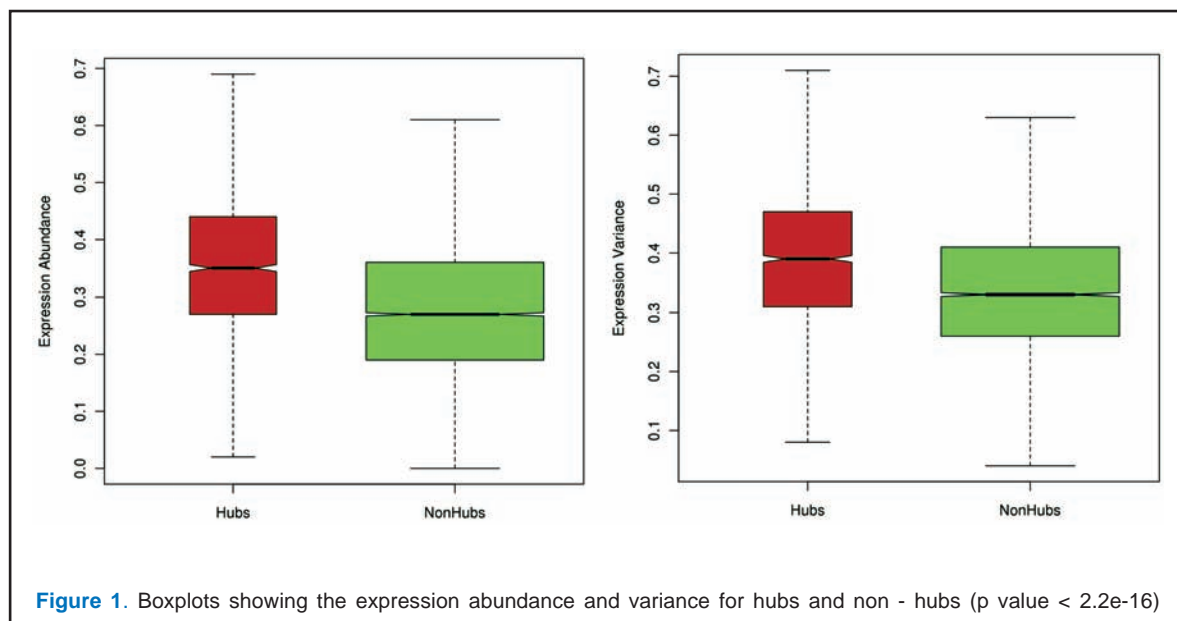
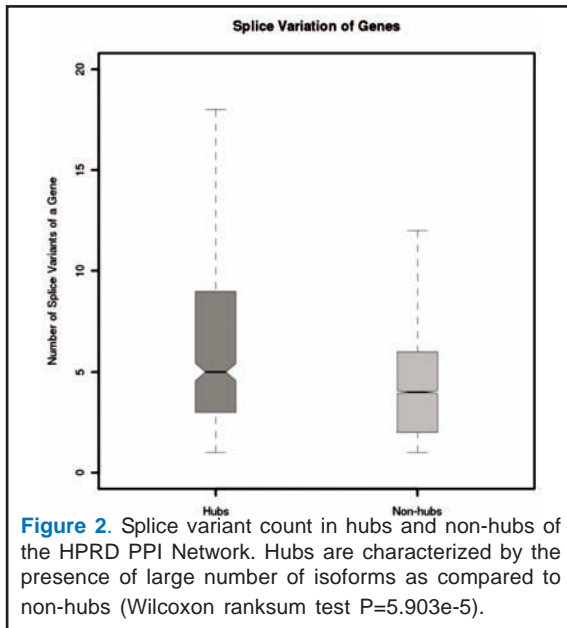

Figure 1. Boxplots showing the expression abundance and variance for hubs and non - hubs (p value $< 2.2e-16$)

Project 3: Structural and functional characterization of hubs in human PPI network

We examined the relation between degree and the number of splice variants of genes/nodes in human PPIN. We found that the hubs in HPRD PPIN have greater number of splice variants than the non-hubs (Figure 2). This observation was confirmed across multiple PPI databases like IntAct, Reactome etc.



We further extended our studies to decipher the relationships between degree and unstructuredness of the nodes. We found that hubs had significantly higher proportion of disorderedness when compared to non-hubs.

Studies were also carried out to examine the relationship between the extent of splice variation and the average unstructuredness of protein products. The nodes with top 5% of the splice variant count showed a considerably higher propensity for disorderedness than the rest of the nodes. Similar studies were performed for nodes with top 10% and 15% of the splice variant count. Again the results obtained showed that genes/nodes with large number of splice variants tend to have high average disorderedness.

We have also analyzed the combined effect of splice variation, domain composition and disorderedness on the degree of the nodes. We mapped domain-domain interaction information onto the HPRD network using the database iPfam. We then calculated the domain-domain interaction degree (DEG_DDI) for each of 1379 nodes. In

essence DEG_DDI represents the number of physical interactions discerned from a database such as HPRD that are further confirmed by domain-domain interaction data. In other words, we identified the degree of nodes due to the presence of interacting domains. We then calculated the difference between the degree (degree difference) discerned from a database (example, HPRD) and the DEG_DDI into three cases of disorderedness of nodes: **structured** proteins (<10% of residues in the unstructured region/s), **moderately unstructured** proteins (10% - 30% of residues in the unstructured region/s), and **unstructured** proteins (> 30% of residues in the unstructured regions). The nodes with high structural disorderedness showed high degree difference as compared to the nodes with low disorderedness (Figure 3) suggesting that the propensity of a node for large number of interactions arises substantially from its structurally disordered splice variants.

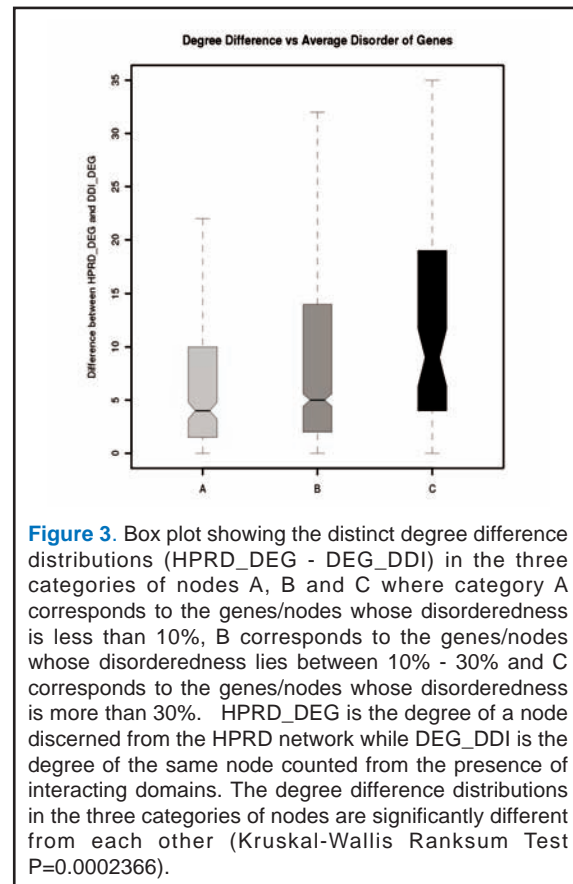

Future plans and directions

1. Integration and analysis of human nsSNP data on protein-protein interaction networks.
2. Further analysis of viral-human bridge PPI network.

3. Studies on tissue-wise PPI networks integrated with drug-protein interaction data.
4. Further studies on structural and functional characterization of hubs in HPPIN.

Publications

1. Kumar P, Chaitanya PS and Nagarajaram HA (2011). PSSRdb: A relational database of polymorphic simple sequence repeats extracted from prokaryotic genomes. **Nucleic Acids Research** 39: D601-D605.
2. Mohammad TA and Nagarajaram HA (2011). A hierarchical approach to protein fold prediction. **Journal of Integrative Bioinformatics** 8: 185.
3. Shamim MT and Nagarajaram HA (2011). SVM-based method for protein structural class prediction using secondary structural content and structural information of amino acids. **Journal of Bioinformatics and Computational Biology** 9: 489-502.
4. Acharya V and Nagarajaram HA (2012). Hansa: An automated method for discriminating

disease and neutral human nsSNPs. **Human Mutation** 33: 332-327.

5. Bashyam MD, Purushotham G, Chaudhary AK, Rao KM, Acharya V, Mohammad TA, Nagarajaram HA, Hariram V and Narasimhan C (2012). A low prevalence of MYH7/MYBPC3 mutations among familial hypertrophic cardiomyopathy patients in India. **Molecular and Cellular Biochemistry** 360: 373-382.
6. Bashyam MD, Chaudhary AK, Reddy EC, Reddy V, Acharya V, Nagarajaram HA, Devi ARR, Bashyam L, Dalal AB, Gupta N, Kabra M, Agarwal M, Phadke SR, Tainwala R, Kumar R and Hariharan SV. A founder ectodysplasin A receptor (*EDAR*) mutation results in a high frequency of the autosomal recessive form of hypohidrotic ectodermal dysplasia in India. **British Journal of Dermatology** (In press).
7. Kumar P and Nagarajaram HA. A study on mutational dynamics of simple sequence repeats in relation to mismatch repair system in prokaryotic genomes. **Journal of Molecular Evolution** (In press).

LABORATORY OF MOLECULAR CELL BIOLOGY

Signal Transduction Pathways in Macrophages and Host-Pathogen Interaction in Tuberculosis

Principal Investigator	Sangita Mukhopadhyay	Staff Scientist
Ph D Students	Khalid Hussain Bhat G Sreejit Nazia Parveen Atul Udgate Arghya Das Gourango Pradhan Parul Singh Vishwanath Jha	Senior Research Fellow Senior Research Fellow Senior Research Fellow Senior Research Fellow Senior Research Fellow Junior Research Fellow Junior Research Fellow Junior Research Fellow (Since Feb. 2012)
Other Members	R Nagender Rao Niteen Pathak Philip Abraham Asma Ahmed Sheikh Ghousunnissa C Chaitanya Krishna K Rajavarman	Scientist B Senior Technical Officer DBT Research Associate I DBT Research Associate I (Since Jul. 2011) Project Assistant (Till Oct. 2011) Project Assistant (Till Jan. 2012) Project Assistant (Till Jun. 2011)
Collaborators	Seyed E Hasnain Pawan Sharma V Valluri and S Aparna	IIT, Delhi ICGEB, New Delhi Mahavir Hospital, Hyderabad BPRC, Hyderabad

Objectives

1. Signal transduction pathways in macrophages regulating its innate-effector functions;
2. Studying how various candidate proteins of *Mycobacterium tuberculosis* interfere with macrophage signaling cascades to modulate host's protective responses against the bacilli.

Summary of work done until the beginning of this reporting year (Upto March 31, 2011)

In our previous studies, we found that the PPE protein Rv1168c plays an important role in the activation of HIV-1 LTR in monocytes/macrophages. LTR activation by Rv1168c was demonstrated by transfection experiments in which the LTR directed the expression of the bacterial enzyme chloramphenicol acetyltransferase (CAT). When THP-1 cells were transfected with the HIV-LTR plasmid construct and treated with various concentrations of the recombinant Rv1168c (rRv1168c) protein (control group) and the LTR activation was determined by measuring CAT expression by ELISA after 36 hours of transfection, it could be observed that rRv1168c potently stimulated CAT expression in THP-1 cells. The

Rv1168c enhanced LTR activity in dose-dependent manner and maximum activity was observed by 3 µg/ml of Rv1168c protein. Since the transfection efficiency in THP-1 cells was low (about 30%), we also used BF-24 cells (THP-1 cells containing a stably integrated HIV-1 LTR promoter sequence driving CAT reporter gene) and a dose-dependent increase in CAT expression was observed with increasing concentrations of rRv1168c in BF-24 cells also. The increased HIV-1 LTR activity was not due to LPS contamination in the recombinant protein preparation and was specific to Rv1168c protein. HIV-1 LTR-driven CAT gene expression was found to be increased by Rv1168c in PMA-differentiated THP-1 macrophages also as well as in human monocyte-derived macrophages. We observed that the Rv1168c protein is a potent transactivator of HIV-1 LTR and can substitute for HIV-1 Tat.

Details of progress made in the current reporting year (April 1, 2011 - March 31, 2012)

1) Understanding the role of a *M. tuberculosis* PPE protein Rv1168c in the activation of HIV-1 long terminal repeat (HIV-1 LTR)

Rv1168c-mediated activation of LTR is dependent on NF- κ B transcription factors

As NF- κ B is one of the most important transcription factors responsible for HIV-1 LTR transcription, we first examined whether NF- κ B is involved in the Rv1168c-mediated activation of HIV-1 LTR. We found that Rv1168c increased p50 and p65 NF- κ B levels in monocyte/macrophages. Further, it was observed that Rv1168c-mediated trans-activation of HIV-1 LTR in monocyte/macrophages cells was strongly inhibited by pyrrolidine dithiocarbamate [(PDTC), a known inhibitor of NF- κ B], suggesting a possible role of NF- κ B in the activation of LTR by Rv1168c. To further underscore the role of NF- κ B in the Rv1168c-mediated activation of HIV-1 LTR, THP-1 cells were transfected with a HIV-1 LTR construct where the NF- κ B binding sites were mutated (pDkB-HIV-CAT) and followed by treatment with rRv1168c (0.3 μ g/ml and 3 μ g/ml) for 36 hours. The results indicate that expression of the CAT reporter gene is significantly down-regulated in the group transfected with pDkB-HIV-CAT as compared to the group transfected with wild-type HIV-1 LTR. All these results confirm a definite role of NF- κ B in the Rv1168c-mediated activation of HIV-1 LTR promoter.

We observed that Rv1168c also increased production of TNF- α in BF-24 cells in a concentration-dependent manner. Interestingly, the recombinant Rv1168c (rRv1168c) was found to activate HIV-1 LTR even in the presence of the specific TNF- α inhibitor indicating that rRv1168c can still activate HIV-1 LTR even when TNF- α production by Rv1168c is inhibited.

Rv1168c interacts with TLR2 to induce NF- κ B-dependent activation of HIV-1 LTR

Various studies have indicated that TLR2 is the most predominant receptor recognized by the *M. tuberculosis* components and plays an important role to modulate macrophage signaling cascades during *M. tuberculosis* infection. TLR2-specific signaling is found to be essential in *M. tuberculosis*-mediated activation of HIV-1 LTR both *in vitro* and *in vivo* as TLR2-deficient transgenic mice harboring HIV-1 pro-viral genome fail to transcribe genes under the control of the LTR promoter. Since Rv1168c could be detected in the insoluble cell wall fraction indicating the fact that Rv1168c is probably surface exposed on *M. tuberculosis* and since rRv1168c protein was found to bind strongly with THP-1 cells, we next investigated whether Rv1168c specifically

recognized the TLR2 receptors and targeted the TLR2-induced signaling to activate HIV-1 LTR. When a pull-down assay was carried out using whole cell extracts prepared from HEK293 cells (which do not express TLRs and therefore can be used to identify ligands for TLRs by over-expressing particular TLRs in these cells) transfected with either pcDNA3.1 or full-length TLR2 or full-length TLR4 over-expression plasmid and incubated with rRv1168c protein immobilized on TALON beads followed by immunoblotting using anti-TLR2 or anti-TLR4 mAb, only TLR2 was detectable in the eluate (Figure 1A). No bands were visible in the control group transfected with pcDNA3.1 or TLR4 or in the group containing only beads (Figure 1A). These observations suggest that Rv1168c interacts specifically with the TLR2 receptors. Again, anti-TLR2 mAb but not anti-TLR4 mAb or isotype-matched (IgG2a) control Ab was able to inhibit binding of Rv1168c on THP-1 macrophages (Figure 1B). These observations further confirm that Rv1168c specifically interacts with the TLR2 receptors.

To investigate whether the interaction of Rv1168c with TLR2 is necessary for increased binding of NF- κ B to LTR DNA and thereby resulting in up-regulation of LTR promoter activity, we next treated BF-24 cells with a TLR2 neutralizing mAb to block binding of Rv1168c with TLR2 and measured both the NF- κ B DNA-binding activity by EMSA and HIV-1 LTR activity by estimating CAT expression levels by ELISA. The results shown in Figures. 1C and 1D indicate that blocking the binding of Rv1168c with TLR2 by pre-treating cells with anti-TLR2 mAb results in poorer NF- κ B DNA-binding activity (Figure 1C) with concomitant inhibition of transcription of the CAT reporter gene from the LTR promoter (Figure 1D). Consistent with our previous observations with neutralizing antibody (Figure 1C and 1D), we found that silencing of TLR2 expression on BF-24 cell surface resulted in strong diminishment of nuclear NF- κ B activity when treated with rRv1168c (Figure 1E). However, in the negative control siRNA-transfected BF-24 cells significant amount of DNA-binding activity was detected (Figure 1E). Expectedly, the levels of NF- κ B DNA-binding activities were well correlated with the LTR-driven CAT gene expression where the CAT expression level in the BF-24 cells transfected with TLR2-specific siRNA were almost reduced to the control levels (Figure 1F). On the other hand, BF-24 cells with negative control siRNA had no significant deviation in the CAT expression levels when stimulated with rRv1168c (Figure 1F). These

results suggest that Rv1168c mainly targets the TLR2 to induce NF- κ B-dependent activation of HIV-1 LTR in BF-24 cells.

Rv1168c activates HIV-1 LTR and requires TLR2-signaling when presented as part of the whole *Mycobacterium*

To check whether Rv1168c could also increase LTR activity when presented in the context of whole bacillus, we infected BF-24 cells with *M.*

smegmatis (the *M. smegmatis* bacillus is known to be a non-pathogenic mycobacterium and its genome does not have most of the PE/PPE genes including Rv1168) over-expressing Rv1168c (*M. smeg*-Rv1168c) and HIV-1 LTR activity was measured at 36 hours post-infection. The control group was infected with *M. smegmatis* harboring the backbone vector alone (*M. smeg*-pVV16). Infection of BF-24 cells with *M. smeg*-Rv1168c as compared to the *M. smeg*-pVV16 resulted in

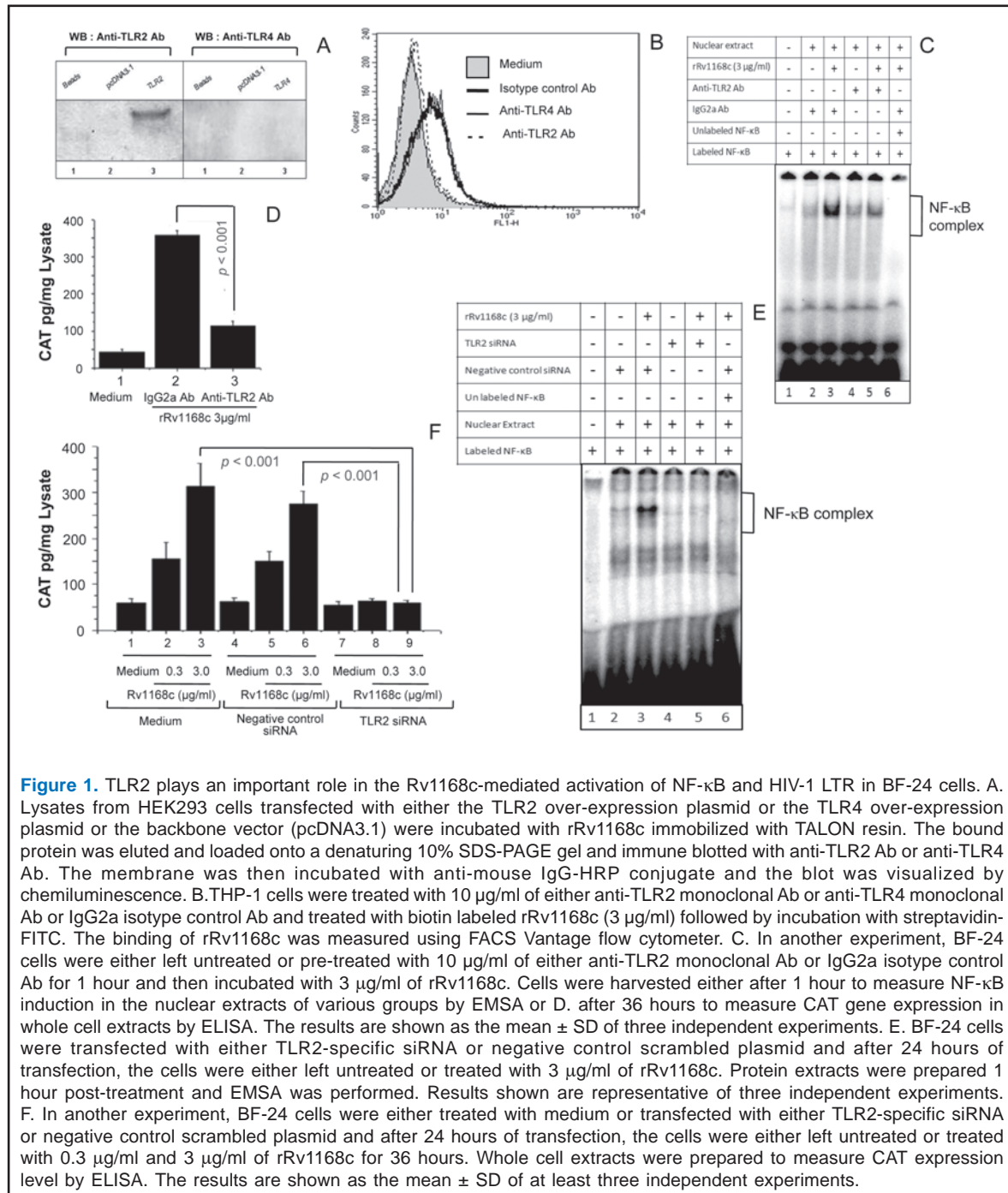

significant enhancement of LTR-driven CAT expression. Also, when Rv1168c was presented in the context of whole bacterium (*M. smeg-Rv1168c*), TLR2 receptor was found to be required to activate NF- κ B and HIV-1 LTR indicating that Rv1168c interacts with TLR2 when presented in the context of the whole mycobacterium and triggers the downstream NF- κ B signaling events that drive increased transcription from the HIV-1 LTR promoter. We demonstrated that the TLR2 leucine rich repeat (LRR) 15~20 domain was important in triggering the downstream signaling events leading to activation of NF- κ B by Rv1168c in monocytes/macrophages.

Deletion of the N-terminal domain of Rv1168c failed to trans-activate HIV-1 LTR promoter in BF-24 cells when infected with *M. smegmatis* over-expressing the deletion mutant

We found that purified truncated Rv1168c protein with an intact N-terminal domain containing 1-173 aa residues (rRv1168 Δ C) was able to sufficiently activate HIV-1 LTR driven transcription to the extent similar to that of the purified full-length protein. In line with our earlier observations, activation of HIV-1 LTR by rRv1168 Δ C was strongly impaired when TLR2 expression in BF-24 cells was suppressed by using TLR2-specific siRNA. These experiments clearly indicate that the N-terminal domain of Rv1168c is essential for activation of HIV-1 LTR in BF-24 cells and this requires TLR2. This suggests that the region encompassing amino acids from 1-173 is crucial to activate TLR2-triggered pro-inflammatory signaling and HIV-1 LTR trans-activation. The full length protein, when presented in the context of the whole mycobacterium in *M. smegmatis* (*M. smeg-Rv1168c*), was also able to activate HIV-1 LTR. Similarly, the N-terminal region was also able to activate NF- κ B and therefore HIV-1 LTR-driven CAT gene expression almost similar to the levels observed by the full length protein when presented in the context of the whole mycobacterium in *M. smegmatis*.

To determine if any role is played by the C-terminal domain, we generated truncated Rv1168c with an intact C-terminal fragment containing 175-346 aa residues, over-expressed it in *M. smegmatis* (*M. smeg-Rv1168 Δ N*), and infected BF-24 cells. We found that the sole C-terminal domain of Rv1168c when presented in the context of the whole bacteria failed to significantly activate NF- κ B as compared

to full length Rv1168c or Rv1168 Δ C. These observations were also well correlated with HIV-1 LTR-driven expression of the CAT gene. These data indicate that the N-terminal region of Rv1168c is the functionally active domain and is required for elicitation of the pro-inflammatory signaling pathway and HIV-1 LTR trans-activation.

Future plans

We would like to study in detail the mechanisms involved in the regulation of anti- and proinflammatory signaling downstream of TLR2 by the PE/PPE proteins of *M. tuberculosis* in macrophages and the detailed roles of the PE/PPE proteins in the trans-activation of HIV-1 LTR.

Publications

1. Das A and Mukhopadhyay S (2011). The evil axis of obesity, inflammation and type-2 diabetes. ***Endocrine, Metabolic and Immune Disorders - Drug Targets*** 11: 23-31.
2. Mukhopadhyay S and Balaji KN (2011). The PE and PPE proteins of *Mycobacterium tuberculosis*. ***Tuberculosis*** 91: 441-447.
3. Nair S, Pandey AD and Mukhopadhyay S (2011). The PPE18 protein of *Mycobacterium tuberculosis* inhibits NF- κ B/rel-mediated proinflammatory cytokine production by upregulating and phosphorylating SOCS3 protein. ***Journal of Immunology*** 186: 5413-5424.
4. Akhter Y, Ehebauer MT, Mukhopadhyay S and Hasnain SE (2012). The PE/PPE multigene family codes for virulence factors and is a possible source of mycobacterial antigenic variation: Perhaps more? ***Biochimie*** 94: 110-116.
5. Mukhopadhyay S, Nair S and Ghosh S (2012). Pathogenesis in tuberculosis: Transcriptomic approaches to unraveling virulence mechanisms and finding new drug targets. ***FEMS Microbiology Reviews*** 36: 463-485.
6. Bhat KH, Chaitanya CK, Parveen N, Varman R, Ghosh S and Mukhopadhyay S. Proline-Proline-Glutamic Acid (PPE) protein Rv1168c of *Mycobacterium tuberculosis* augments transcription from HIV-1 Long Terminal Repeat promoter. ***Journal of Biological Chemistry*** (In press).

LABORATORY OF STRUCTURAL BIOLOGY

Structural and Biochemical Characterization of Some *M. tuberculosis* Proteins

Principal Investigator	Shekhar C Mande	Staff Scientist (Till Aug. 2011)
PhD Students	N Madhav Rao Pramod Kumar Shubhada Hegde Arpita Goswami Aditi Sharma Swastik Phulera	Senior Research Fellow (Till May 2011) Senior Research Fellow (Till Oct. 2011) Senior Research Fellow (Till Feb. 2012) Senior Research Fellow Junior Research Fellow Junior Research Fellow
Other Members	Payel Ghosh A Sheeba Ch Neeraja Ashwani Kumar Susan Bosco	Scientist B Technical Officer I DBT Post Doctoral Fellow Project Associate Project Junior Research Fellow (Till Nov. 2011)
Collaborators	Anil Tyagi Kanury Rao Abhijit A Sardesai Sanjeev Khosla David Sherman	University of Delhi, South Campus ICGEB, New Delhi CDFD, Hyderabad CDFD, Hyderabad SBRI, Seattle

Objectives

1. Identification of important proteins of *Mycobacterium tuberculosis* for crystallographic and biochemical analysis;
2. Expression and biochemical characterization of the chosen proteins. X-ray structural analysis of the chosen proteins;
3. Develop applications of graph theory to understand genome-wide protein:protein interactions.

Summary of work done until the beginning of this reporting year (upto March 31, 2011)

Three broad categories of proteins from *Mycobacterium tuberculosis* were chosen for biochemical and structural work. They are:

Chaperonins

We had demonstrated earlier that GroEL-1 is capable of binding to DNA without any sequence specificity. The affinity of DNA recognition by GroEL-1 is sufficiently high, in the range of 100-200 nM, suggesting that the protein has naturally evolved to bind DNA. This property of GroEL-1 was proposed to be due to its participation in nucleoid formation in *M. tuberculosis*.

Details of progress made in the current reporting year (April 1, 2011 - March 31, 2012)

Project 1: Structural characterization of NrdH

Ribonucleotide reduction is an essential biochemical process. *M. tuberculosis* Ribonucleotide reductases (NrdE-F2) perform this reaction with NrdH serving as the hydrogen donor. NrdH is a Thioredoxin like protein with a

Redox proteins	<ul style="list-style-type: none"> ❖ Thioredoxin and thioredoxin reductase ❖ Glutaredoxin
Heat shock proteins	<ul style="list-style-type: none"> ❖ Chaperonin-60 family (Cpn60.1, Cpn60.2 and Cpn10) ❖ Heat shock protein 70 family (Hsp70, Hsp40)
Other proteins including proteins involved in transcription processes	<ul style="list-style-type: none"> ❖ cAMP receptor protein ❖ YefM:YoeB toxin-antitoxin complex

Glutaredoxin like sequence. We demonstrate that this protein can *in vitro* be reduced by Thioredoxin reductase and also that it can reduce Insulin *in vitro* (when used as a model substrate). Towards the structural characterization of this protein, we have successfully solved the structure of this protein at 1.67Å. Also, we have collected high resolution diffraction data at 1Å resolution, the refinement of which is in progress.

Since little information is known about the NrdH protein family per se, we have done phylogenetic analysis of NrdH along with Thioredoxins and Glutaredoxins. We believe that NrdH represents a separate class within proteins having a thioredoxin fold. We observe that the sequence motifs present in NrdH are different from those observed in Thioredoxins and Glutaredoxins. Further investigations as to what makes NrdH able to accept electrons from Thioredoxin reductase, while Glutaredoxins are incapable to do so are underway. We hypothesize that the answer to this lies within patterns of residue co-operativity in the three dimensional structure of these proteins and it is the functional interactions within amino acid pairs that define the functional differences among these classes of proteins.

Project 2: Molecular characterization of Chaperonins

To comprehend the role of GroEL-1 in binding to DNA, we carried out comparative studies on *M. tuberculosis* H37Rv (WT) and *M. tuberculosis* *groEL-1* knockout (KO). Growth curve analysis with the WT, KO and *groEL-1* complemented strain (Comp) showed that there was no growth defect shown by the KO in 7H9 media (Figure 1). Gene expression profiling of the KO and WT were done under five stress conditions (Table 1) using Nimblegen arrays. Five biological replicates were taken for each of the stress conditions. All genes

which showed a 2 fold change and were at 99% confidence using the Student's t test were taken as significant differentially expressed genes in KO in comparison to the WT. A large number of genes were found to be differentially expressed in the stationary phase, cold shock and mild cold shock compared to conditions low pH and low aeration. While PE PGRS genes were highly upregulated in pH stress, ribosomal genes showed an increased expression at stationary phase in the KO.

Condition		Number of genes
Cold shock	On ice	398
Mild cold shock	At room temperature	316
Low pH	pH = 5.5	35
Low aeration	Standing culture at 37° C	53
Stationary phase	OD 2.2	643

Table 1. Number of genes differentially expressed in the KO vs. the WT under each of the stress conditions.

Project 3: Evidence for enhanced correlated gene expression under conditions of impaired DNA supercoiling

A compendium of large scale gene expression studies was employed to investigate the effects of perturbations in DNA supercoiling on gene regulation. The most interesting outcome was upon the segregation of supercoil impaired and supercoil stable conditions to study the expression correlations calculated in these two categories. A remarkable increase in the number of correlated and inversely correlated gene pairs upon perturbations in DNA supercoiling was apparent, thereby confirming that DNA topology indeed affects transcriptional control (Figure 2). Interestingly,

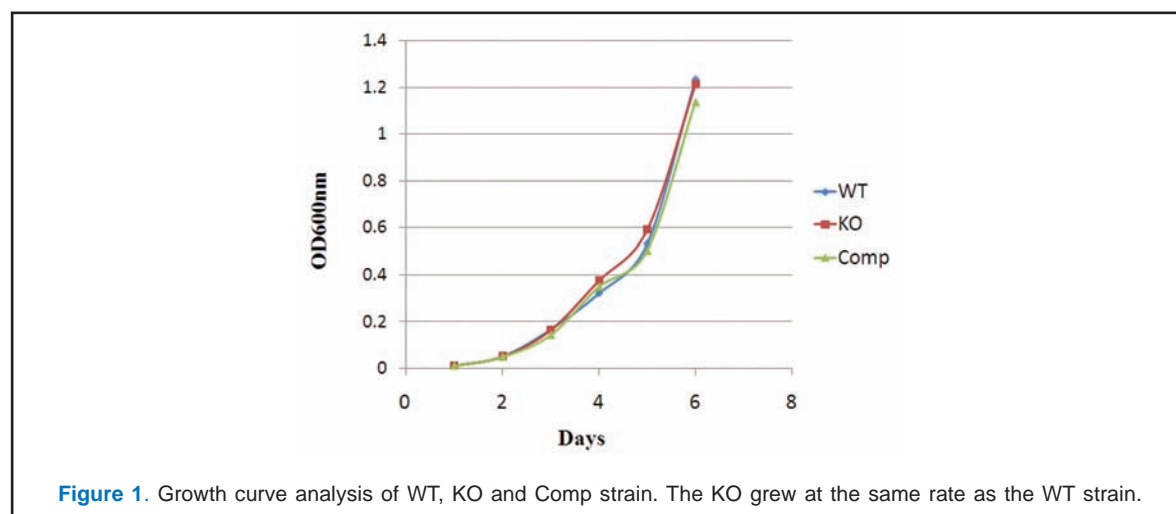
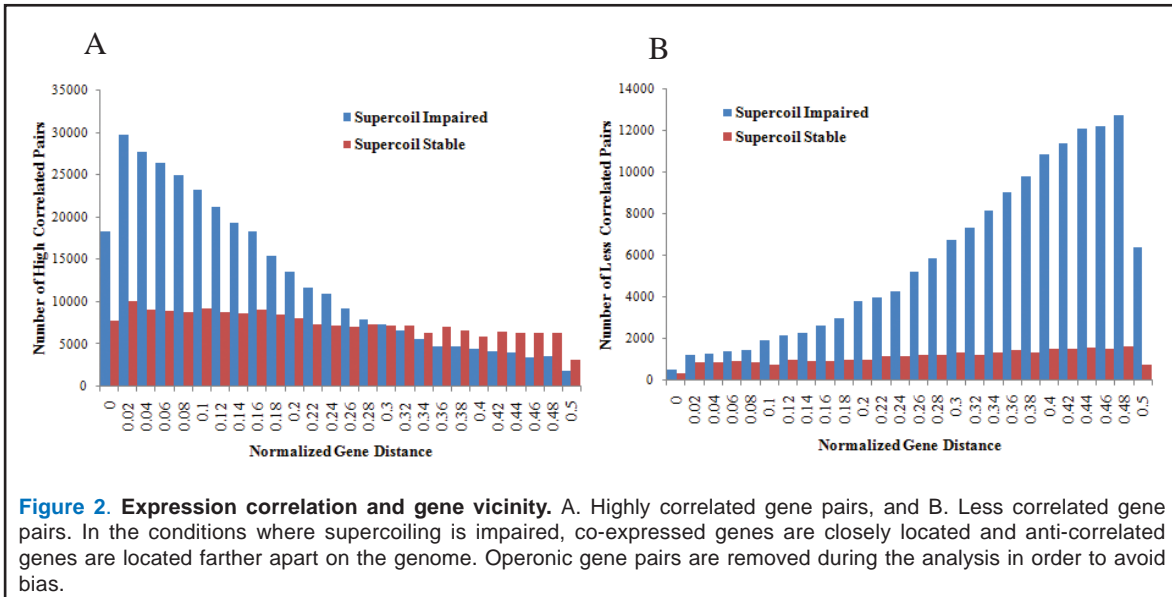

Figure 1. Growth curve analysis of WT, KO and Comp strain. The KO grew at the same rate as the WT strain.



closely located gene pairs on the genome exhibit high correlation whereas genes located far from each other exhibit high inverse correlation upon loss of control on DNA supercoiling. Such a pronounced distance dependence of expression correlation in the supercoiling insensitized conditions suggests that transcription processes might also be affected by DNA supercoiling.

Project 4: Study of DNA binding proteins in *E. coli* and their role in organization of nucleoid structure

Unlike eukaryotes, some of the basic elements of DNA compaction such as histones are absent in bacteria, and therefore exact molecular mechanisms of bacterial chromosome packaging are still unclear. Among the factors facilitating DNA

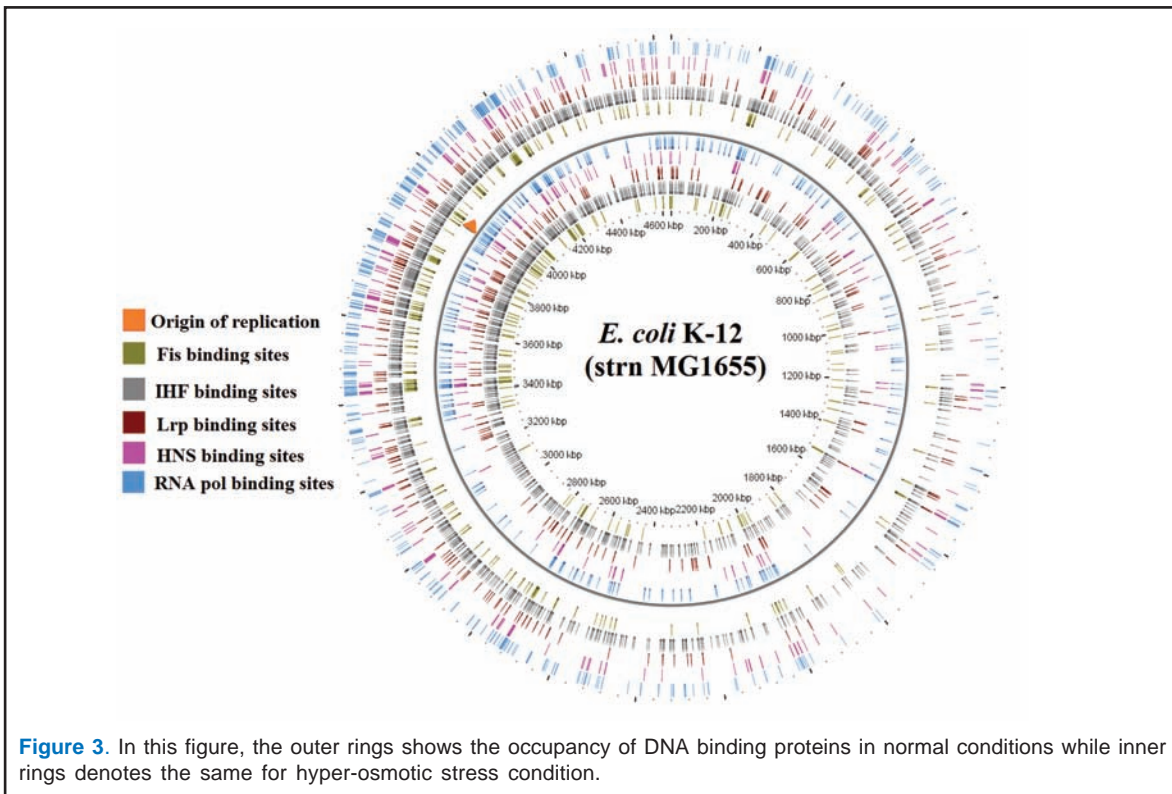

condensation, binding of nucleoid associated proteins (NAPs) may play a major role in prokaryotic genome organization. The aim of the study is to identify different sites on the *Escherichia coli* genome where the NAPs might bind and how their association helps to form a compact nucleoid structure. The complete genome of the *E. coli* K12 isolate MG1655 was reviewed for DNA-protein binding sites, with the help of 'ChIP-chip' experiments for a normal set of cells and also, after subjecting them to hyperosmotic stress (imposed by high concentrations of sucrose). Comparison of results obtained for different *E. coli* cultures indicate if-and-how the binding patterns of some NAPs change in course of cellular osmoregulation (Figure 3). The reported trends in binding of NAPs are expected to better reveal the structural organisation and dynamicity of the *E. coli* nucleoid.

Project 5: Genome-wide prediction of Genetic Synthetic Phenotypes

Genetic perturbation, such as a gene mutation has been a widely used tool to address functional aspects of genes in many model organisms. In certain cases, simultaneous multiple gene perturbations have also been used. For example, two genes whose individual deletion mutants have minimal growth defects, while the double knockout results in a significant growth defect under a given condition. Such double mutants/knock outs are referred to as Genetic Synthetic Phenotypes (GSP). Conventional approaches that have been

used to explore genetic interactions are now being replaced by recent advances in the high-throughput methodologies. Although such high-throughput studies have shown remarkable potential to deal with experimental bottlenecks, it continues to be a daunting task to experimentally map pairwise genetic interactions for a whole genome due to time and expenses. In this study we have predicted genome-wide GSP in *S. cerevisiae* and *E. coli* using gold standard network and genomic features. We applied 8 different Machine Learning (ML) approaches out of which 4 are novel for the prediction of genetic interactions. Best 5 ML approaches were considered for the final GSP count. In our knowledge, this is the first computational study for the prediction of genome-wide GSP for *E. coli*. By doing so, we show that our method can be implemented on both Eukaryotes as well as Prokaryotes. We experimentally validated our predicted interactions for 3 cell division genes in *E. coli* and identified 14 new GSP. We also predicted direct protein interaction linkages using our predicted GSPs. We account better performance in genetic interactions prediction as demonstrated by *Matthews Correlation Coefficient*, ROC and Precision-Recall curves. Figure 4 shows that genes B and C make a functional pathway and genes D, X and E make another.

Future plans and directions

- ❖ Overexpression, purification and crystallization of NrdE and NrdF proteins.
- ❖ Analysis of microarray experiments of WT and groEL1 KO strains.
- ❖ Analysis of genome-wide correlations of expression.

Publications

1. Arora A, Chandra NR, Das A, Gopal B, Mande SC, Prakash B, Ramachandran R, Sankaranarayanan R, Sekar K, Suguna K, Tyagi AK and Vijayan M (2011). Structural biology of *Mycobacterium tuberculosis* proteins: The Indian efforts. *Tuberculosis* 91: 456-468.
2. Hegde S, Klimova E, Mande S, Medvedeva IA, Makeev V and Permina EA (2011). Using the operonic gene pairs for establishing the threshold correlation coefficient of differently expressed genes. *Biofizika* 56: 1062-1064. [Article in Russian]

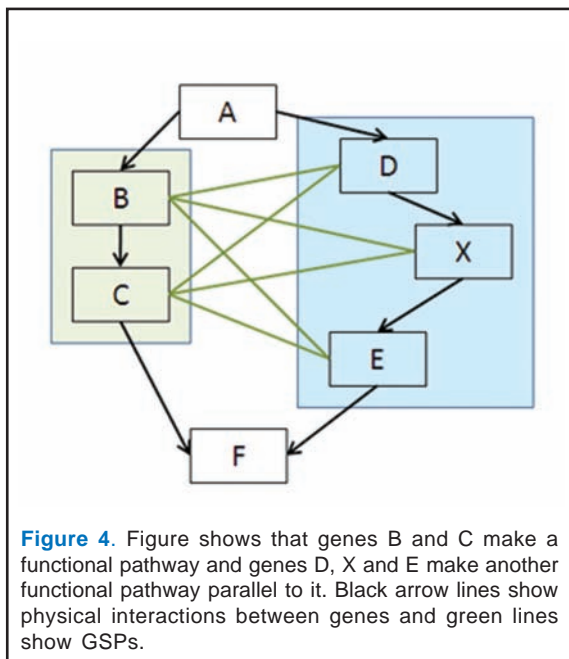

Figure 4. Figure shows that genes B and C make a functional pathway and genes D, X and E make another functional pathway parallel to it. Black arrow lines show physical interactions between genes and green lines show GSPs.

3. Jailkhani N, Ravichandran S, Hegde SR, Siddiqui Z, Mande SC and Rao KVS (2011). Delineation of key regulatory elements identifies points of vulnerability in the mitogen-activated signaling network. **Genome Research** 21: 2067-2081.
4. Kumar CMS and Mande SC (2011). Protein chaperones and non-protein substrates: On substrate promiscuity of GroEL. **Current Science** 100: 1646-1653.
5. Hegde SR, Rajasingh H, Das C, Mande SS and Mande SC (2012). Understanding communication signals during Mycobacterial latency through predicted genome-wide protein interactions and boolean modeling. **PLoS One** 7: e33893.

LABORATORY OF MAMMALIAN GENETICS

Epigenetic Mechanisms Underlying Developmental Pathways

Principal Investigator	Sanjeev Khosla	Staff Scientist
PhD Students	Divya Tej Sowpati Garima Sharma Amitava Basu Rachana Roshan Dev Imtiyaz Yaseen Thushara Thamban	Senior Research Fellow Senior Research Fellow Senior Research Fellow Senior Research Fellow Junior Research Fellow Junior Research Fellow (Since Jul. 2011)
Other Members	M Srilalitha Vaishnavo Pai Bindu Bhargavi N Vanitha	Technical Officer I Project Associate Project Assistant (Till Nov. 2011) Project Assistant (Till Jun. 2011)
Collaborators	Gayatri Ramakrishna Shekhar Mande Rakesh Mishra Vinay K Nandicoori	CDFD, Hyderabad CDFD, Hyderabad CCMB, Hyderabad NII, New Delhi

Project 1: *DNMT3L*: Role in development

Summary of work done until the beginning of this reporting year (upto March 31, 2011)

We had previously initiated studies in *Drosophila* to analyze the regulatory mechanisms underlying the transcription of *DNMT3L*. Transgene reporter assay in *Drosophila* was performed wherein the promoter region flanked by *loxP* sites, was inserted upstream of the *hsp70* promoter driven *mini-white* reporter gene containing P-element vector pCaSpeR. We also reported loss of DNA methylation at the *DNMT3L* promoter in a larger

cohort of cervical cancer patients. This loss of DNA methylation was also observed in tongue, esophagus and colorectal cancer samples.

Details of progress made in the current reporting year (April 1, 2011 - March 31, 2012)

Role of *DNMT3L* promoter in regulation of its transcription

To gain insight into the regulatory elements present within the *DNMT3L* promoter/ Exon1 region, we performed reporter gene assay in *Drosophila* and mammalian cell lines.

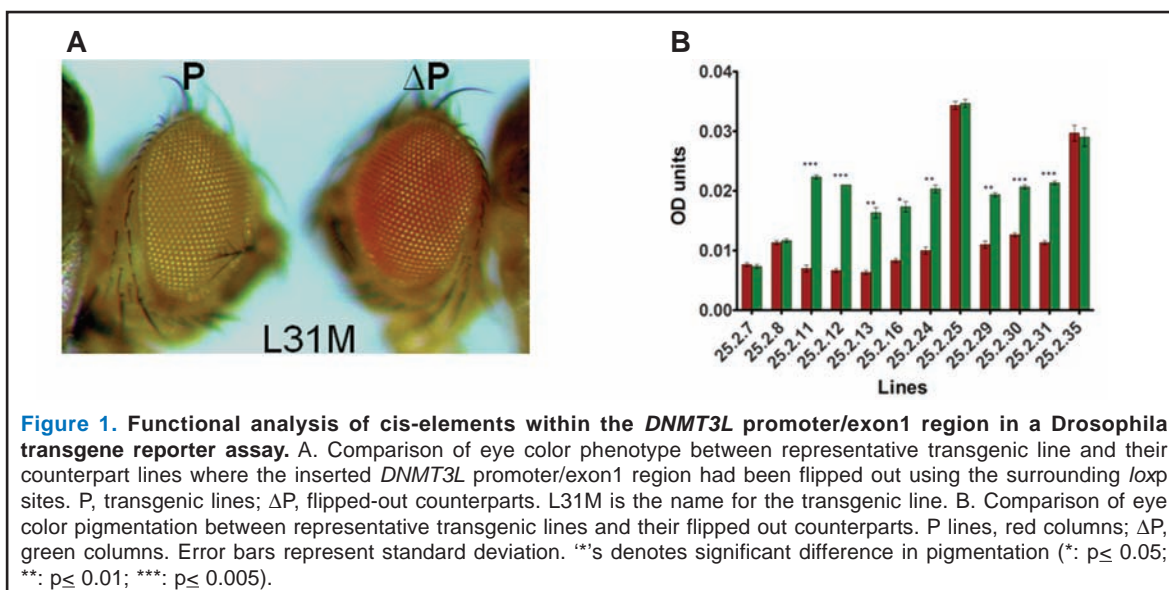

In the transgene reporter assay in *Drosophila* the *DNMT3L* promoter/ Exon1 region flanked by loxP sites was inserted upstream of the *hsp70* promoter driven *mini-white* reporter gene. The comparison of eye color for the transgenic lines with lines lacking the promoter was performed. As shown in Figure 1, the presence of *DNMT3L* promoter/ Exon1 region in the reporter construct lead to decrease in the transcriptional potential of the *hsp70* promoter indicating that the *DNMT3L* promoter/Exon1 region was acting as a transcriptional repressor.

For the transfection reporter assay, the *DNMT3L* promoter/Exon1 region was cloned upstream of the CMV promoter in the pAcGFP1-CMV vector to examine the effect of this region on the transcription of GFP reporter gene under the CMV promoter. Upon transfection into mammalian cell lines, the analysis of the reporter gene transcription showed that the presence of *DNMT3L* promoter/Exon1 region in the reporter construct causes repression of the GFP expression.

Project 2: Host epigenetic response to infection.

Summary of work done until the beginning of this reporting year (upto March 31, 2011)

To influence the epigenetic circuitry of the human host cells, a mycobacterium needs to possess factors (proteins/RNA) which could interact or influence the effectors of epigenetic modifications. 17 of the 29 annotated putative methyltransferases in the *Mycobacterium tuberculosis* genome were taken up for an initial analysis to examine their:

- i) DNA methyltransferase activity;
- ii) Ability to get secreted out of the mycobacterium;
- iii) Subcellular localization in the host cell upon infection.

Details of progress made in the current reporting year (April 1, 2011 - March 31, 2012)

In order to respond to the infection by *M. tuberculosis*, the host cells would have to

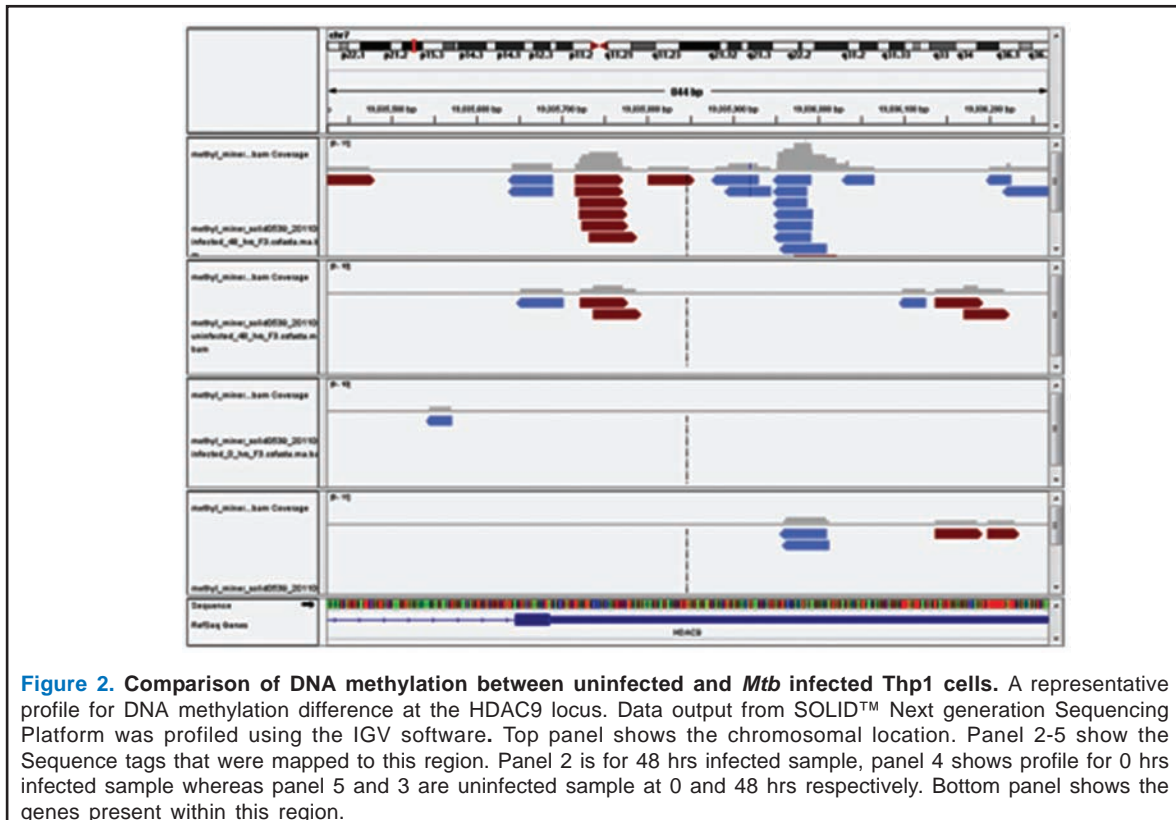

reprogram the epigenetic markings at several loci in the genome so that the affected gene may be appropriately modulated. One of the aims of our study is to examine these epigenetic changes and identify the genetic loci where these changes are

brought about. This, we believe, will provide us important evidence about the genes in the host that might be participating in a response to mycobacterial infection. To examine the DNA methylation changes upon infection, PMA treated

THP1 cells (Human acute monocytic leukemia cell line) were infected with *M. tuberculosis*. DNA isolated from the host cells was analysed by Methylated DNA ChIP-Seq. We were able to identify more than 300 loci in the THP1 cell genome that showed change in DNA methylation upon infection (representative DNA methylation difference shown in Figure 2). Validation of these results and the consequent effect of these changes on the expression of affected genes are ongoing.

Project 3: Specialized chromatin structures as epigenetic imprints to distinguish parental alleles.

Summary of work done until the beginning of this reporting year (Upto March 31, 2011)

We obtained, through a collaboration with CDB, Kobe and NCBS, Bangalore, mice which had the second intron of *Neuronatin* replaced by a Neo-cassette at its endogenous locus (referred to as *NnatΔI²* henceforth). In the previous years we had examined the effect of this deletion on the expression of the imprinted *Neuronatin* gene.

Details of progress made in the current reporting year (April 1, 2011 - March 31, 2012)

Functional analysis of *Neuronatin*'s second intron (NNI²)

To test the possibility that the second intronic region of *Neuronatin* is a transcriptional activator even in mammals, mice in which the second intron of *Neuronatin* had been deleted were generated. We had previously reported loss of *Neuronatin* expression in paternal heterozygous and homozygous *NnatΔI²* mice indicating the role of NNI² as a transcriptional activator. Further analysis of these mice showed that the NNI² deletion also affected the expression of *Bicap* the other imprinted gene in the locus. Moreover, DNA methylation analysis indicated that loss of *Neuronatin* expression in paternal heterozygous and homozygous *NnatΔI²* mice was correlated with gain of DNA methylation at the *Neuronatin* promoter. Moreover, *NnatΔI²* mice were found to have aberrant body weight as compared to their wild type littermates. While paternal heterozygous and homozygous *NnatΔI²* mice showed higher body

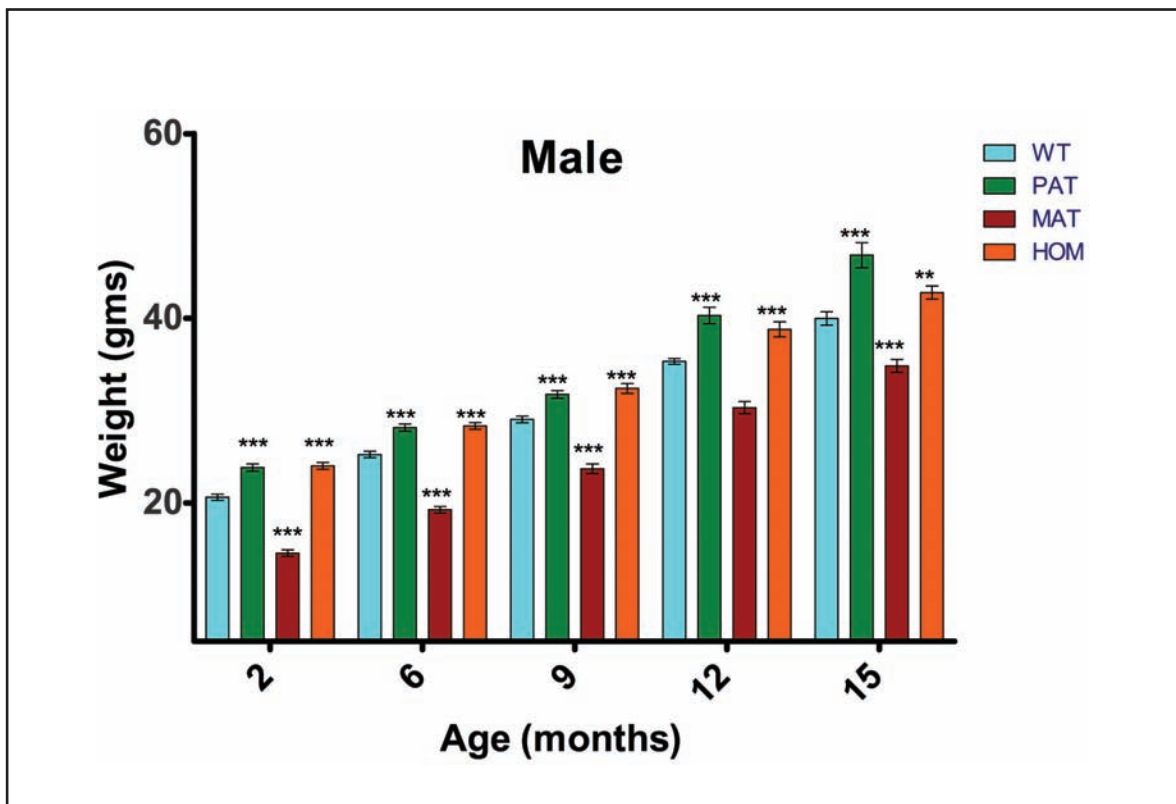

Figure 3. *NnatΔI²* mice show aberrant body weight. Body weight for the different categories of mice was measured at the indicated ages. 15 mice for each category were examined. WT: wild type; PAT: paternal heterozygous *NnatΔI²* mice; MAT: maternal heterozygous *NnatΔI²* mice; HOM: homozygous *NnatΔI²* mice. *: $p \leq 0.05$; **: $p \leq 0.01$; ***: $p \leq 0.005$.

weight, the maternal heterozygous $Nnat\Delta I^2$ were lighter than the wild type mice (Figure 3).

Publications

1. Singh NP, Madabhusi SR, Srivastava S, Senthilkumar R, Neeraja C, Khosla S and Mishra RK (2011). Epigenetic profile of the euchromatic region of human Y chromosome. ***Nucleic Acids Research*** 39: 3594-3606.

2. Thiagarajan D, Dev RR and Khosla S (2011). The DNA methyltransferase Dnmt2 participates in RNA processing during cellular stress. ***Epigenetics*** 6: 103-113.

Other publications

1. Gokul G and Khosla S. DNA methylation and cancer. ***Epigenetics: Development and Disease***. Editor: Kundu TK. Springer Publications (In press).

LABORATORY OF MOLECULAR ONCOLOGY

Genomics and Molecular Genetics of Cancer and Human Genetic Disorders

Principal Investigator	Murali D Bashyam	Staff Scientist
PhD Students	Ratheesh Raman M Khursheed P Ramaswamy Adduri S Rama Raju Dimendra Hazarika	Senior Research Fellow Senior Research Fellow Senior Research Fellow Senior Research Fellow Junior Research Fellow (Since Jul. 2011)
Other Members	Ajay K Chaudhary Jayaprakash Kolla K Viswakalyan Brijesh Yadav V Chandrasekhar	Technical Assistant Research Associate (Since Dec. 2011) Research Assistant Research Assistant Junior Project Technician
Collaborators	A Dalal HA Nagarajaram G Swarnalata RA Sastry R Kongara S Koganti C Sundaram S Uppin M Srinivasulu D Desai Subramanyeswar Rao KVN Raju AR Ramadevi Ramana Davuluri	CDFD, Hyderabad CDFD, Hyderabad Apollo Hospitals, Hyderabad NIMS, Hyderabad NIMS, Hyderabad NIMS, Hyderabad NIMS, Hyderabad NIMS, Hyderabad MNJ Hospital, Hyderabad Hinduja Hospital, Mumbai IACHRC, Hyderabad IACHRC, Hyderabad Sandor Proteomics, Hyderabad Wistar Institute, USA

Objectives

1. Identification and characterization of important deregulated genes/pathways in cancers prevalent in India;
2. Identification and characterization of disease causing mutations in genetic disorders.

Summary of work done until the beginning of this reporting year (upto March 31, 2011)

Colorectal cancer (CRC)

Work carried out during the previous reporting year indicated specific biological differences in tumors occurring in rectum and colon especially in young patients. The reduced occurrence of Wnt activation in early-onset CRC was more pronounced in rectal tumors as compared to colonic tumors. In addition, K-Ras mutation frequency was significantly reduced in rectal cancer occurring in the young but not in the elderly unlike colonic cancer. No

significant difference was however observed with respect to p53 and microsatellite instability status; neither between the two age groups nor between colon and rectum. Surprisingly, the Wnt- samples exhibited significant chromosomal aberrations. In parallel, we profiled genetic aberrations causing Hereditary Non-Polyposis Colorectal Cancer (HNPCC) in Indian patients. Surprisingly, only 42 % of suspected HNPCC patient samples were negative for MLH1/MSH2 protein expression, though 85% samples exhibited microsatellite instability confirming their HNPCC status. Mutations were identified in 10 of 11 samples screened including five novel mutations; four in *hMsh2* and one in *hMlh1*. Loss of heterozygosity appeared to be the most common mode of somatic inactivation of the second allele.

Pancreatic cancer

During the previous reporting year, we characterized a novel tumor suppressor gene for pancreatic

cancer based on analysis of a recurrent deletion located at 6q25.3, which included only one annotated gene viz. *ARID1B* encoding a component of the human SWI/SNF chromatin remodeling complex. Permanent transfectants generated in MiaPaCa2 (harboring a homozygous deletion for *ARID1B*) exhibited reduced ability to form colonies in liquid as well as solid culture when compared to vector transfectants. However, there was no significant difference in growth as determined by MTT and crystal violet staining. We detected elevation of *ARID1B* transcript upon treatment with 5'-Azacytidine in several pancreatic cancer cell lines harboring a mono-allelic loss of *ARID1B*, indicating that the second allele might be repressed through promoter hypermethylation. A CpG island was identified in the *ARID1B* promoter and bisulphite sequencing revealed extensive hypermethylation.

Details of progress made in the current reporting year (April 1, 2011 - March 31, 2012)

Project 1: Molecular genetic analyses of early-onset sporadic CRC

A careful analysis of copy number alterations identified in Wnt- and Wnt+ colorectal tumors revealed the presence of a high level amplification at 5p11.2 (Figure 1A). This locus harbors the hTERT gene. Next we performed genome-wide transcript profiling using microarrays on RNA isolated from Wnt- and Wnt+ colorectal tumor

samples. Preliminary analysis revealed Wnt pathway genes to be differentially expressed in the two colorectal cancer subtypes confirming the Wnt status of the tumors. Computational analysis to identify pathways driving tumorigenesis in Wnt-samples is currently underway. Next we performed genome-wide RNA sequencing using RNA isolated from two Wnt- and Wnt+ early-onset rectal cancer samples each. The samples were matched for grade and stage, were microsatellite stable, wild type for *KRAS* and mutant for *TP53* (Figure 1B). Differential expression analysis using DEseq and Cuffdiff is currently underway. In parallel, we continued our studies on HNPCC. We further analyzed MSH6/PMS2 status in the suspected HNPCC patient samples that were positive for MLH1/MSH2 expression. Of the 31 samples tested, only 2 were negative for MSH6 expression and 3 for PMS2; no mutations were detected in these 5 samples. Since it is possible that mutation might not result in loss of protein expression, we next screened all remaining 26 samples for mutation in the four genes. We detected the MSH2 c.67 T>C (p.F23C) in two samples and the PMS2 c.-88 C>T (5' UTR) mutation in one sample. MLPA kit (MRC; Holland) based evaluation of possible mono-allelic single exon copy number gains and losses in the MLH1 and MSH2 genes in the remaining samples where no mutation was detected, yielded negative results. Therefore, in 23 of the total 46 samples (50%) we could not detect

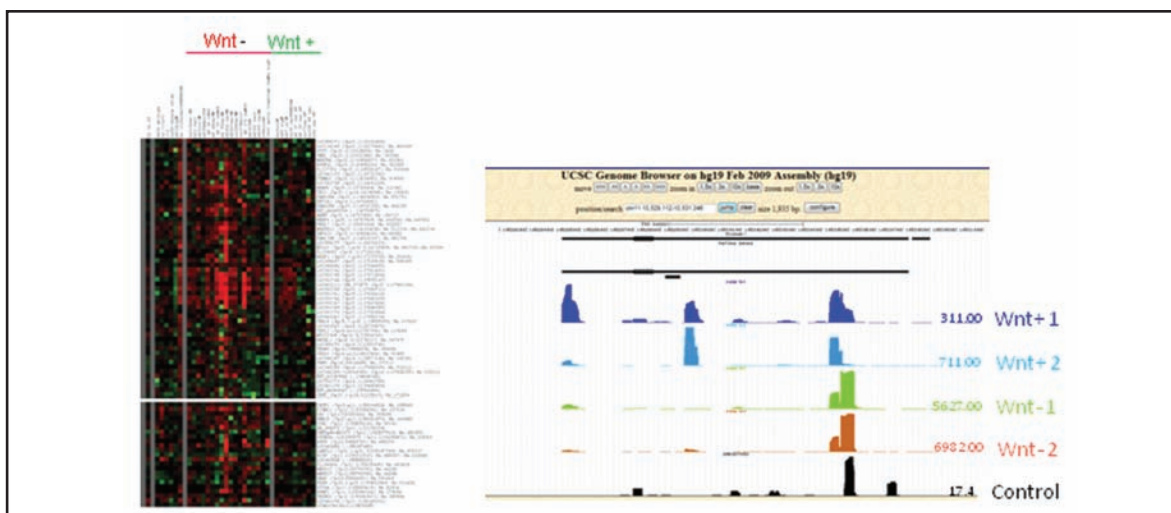

Figure 1. Identification of genetic alterations distinguishing Wnt- and Wnt+ CRC. Panel A shows identification of high level amplification at 5p15.1-2 (hTERT; top) and 7p12 (EGFR; bottom) exclusively in Wnt- CRC samples as determined through array-based comparative genomic hybridization. Panel B shows representative region exhibiting differential transcript profiles as determined through next generation RNA sequencing analysis. The *MTRNR2L8* gene exhibits significantly elevated transcript levels in Wnt- samples (green and magenta) as compared to Wnt+ samples (dark blue and light blue). The result from brain transcripts (black) is shown as a control. The FPKM value for each sample is given on the right side in the same colour code.

any genetic lesion in the four common genes suggesting thereby the possibility of involvement of novel hitherto unidentified genes in HNPCC patients from India.

Project 2: Identification and characterization of novel pancreatic cancer genes

We first confirmed that the *ARID1B* permanent transfectants generated in MiaPaCa2 did not exhibit a significantly different rate of apoptosis (as measured through Hoechst staining and AnnexinV assay) as well as growth (as measured using cell cycle analysis on FACS) when compared to vector transfectants. We next evaluated effect of Trichostatin A (TSA) on *ARID1B* expression in pancreatic cancer cell lines. Varying

tissue as compared to normal pancreas in a high proportion of samples as evaluated using immunohistochemistry. Thus *ARID1B* appears to be a novel tumor suppressor for pancreatic cancer (Figure 2B).

Project 3: Molecular genetic analysis of maple syrup urine disease

This is a new activity. Maple Syrup Urine Disease (MSUD) is a rare metabolic disorder caused by reduced/absent activity of the branched chain α -Ketoacid dehydrogenase enzyme complex. Mutations in *BCKDHA*, *BCKDHB* and *DBT*, that encode important subunits of the enzyme complex namely E1 α , E1 β and E2, are the primary cause for the disease.

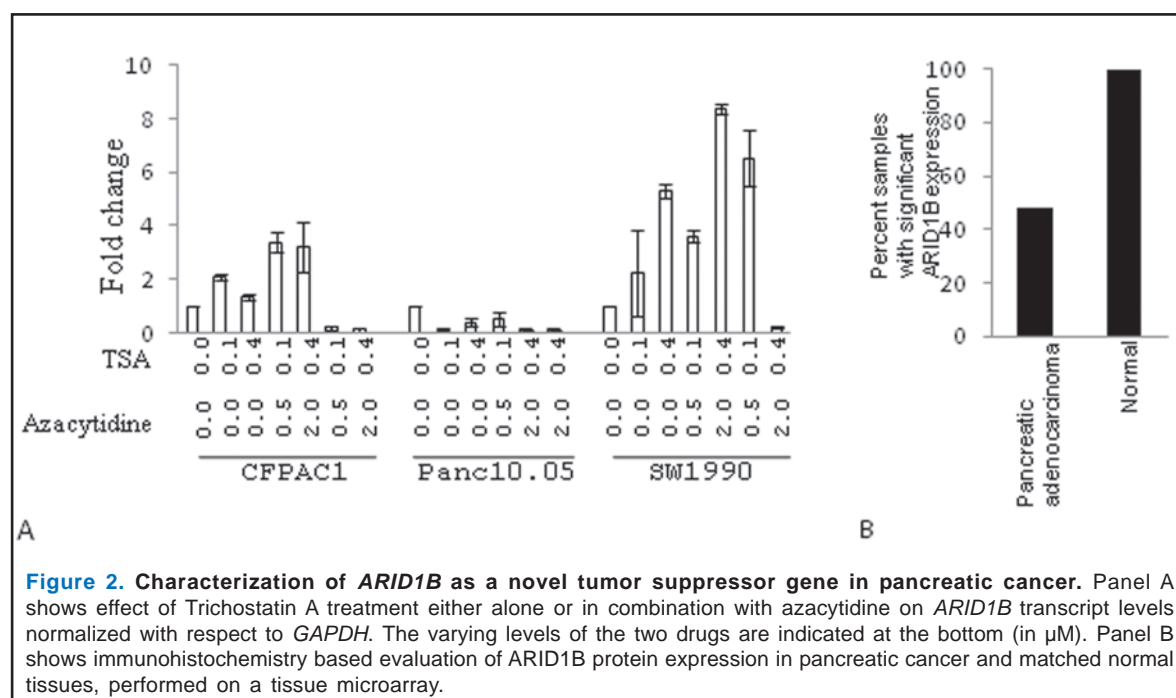

concentrations of TSA, either alone or in combination with azacytidine, resulted in a significant increase in *ARID1B* transcript levels in several cell lines (Figure 2A). In order to assess the clinical significance of *ARID1B* in pancreatic cancer, we generated a pancreatic cancer tissue microarray comprising of a) pancreatic adenocarcinoma from head of pancreas, tail of pancreas, ampulla of vater and duodenum and b) pancreatic neuroendocrine tumors in addition to matched normal tissue for each tumor. Normal and cancerous tissues from stomach, colon, esophagus and normal tissues from muscle and placenta were also included as controls. *ARID1B* exhibited significantly reduced expression in tumor

We have performed the first molecular genetic analysis of MSUD from India on nine patients exhibiting classical MSUD symptoms. *BCKDHA* and *BCKDHB* mutations were identified in four and five patients respectively including seven novel mutations namely the *BCKDHA* c.1249delC, c.1312T>C and c.1561T>A and the *BCKDHB* c.401T>A, c.548G>A, c.964A>G, and c.1065delT. The *BCKDHB* c.853C>T (p.R285X) mutation was shown to trigger nonsense mediated decay-based transcript degradation (Figure 3). Seven of the total eleven mutations resulted in perturbations in the E1 α or E1 β C-termini either through altered termination or through an amino acid change; these are expected to result in disruption of E1 enzyme

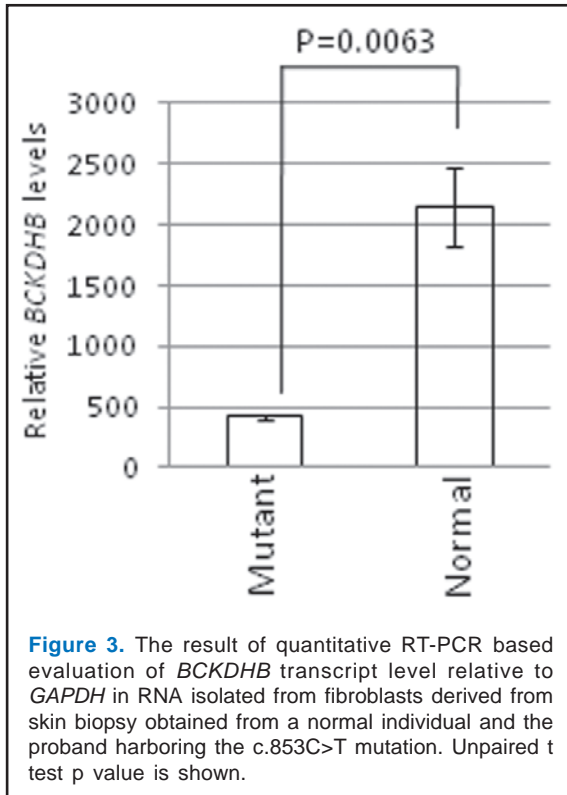

complex assembly. Our study has therefore revealed that *BCKDHA* and *BCKDHB* mutations might be primarily responsible for MSUD in the Indian population.

Future plans and direction

Genome-wide transcript profiling using microarrays and RNA Sequencing will be continued to identify tumorigenesis pathways driving CIN+/Wnt-/MSI-early-onset rectal cancer.

Further characterization of *ARID1B* and its transcriptional targets with respect to pancreatic cancer will be carried out.

Characterization of selected mutations affecting transcript stability/processing identified through screening of various genetic disorders will be characterized.

Publications

1. Kwei KA, Shain AH, Bair R, Montgomery K, Karikari CA, van de Rijn M, Hidalgo M, Maitra A, Bashyam MD and Pollack JR (2011). *SMURF1* amplification promotes invasiveness in pancreatic cancer. ***PLoS One*** 6: e23924.
2. Bashyam MD, Purushotham G, Chaudhary AK, Rao KM, Acharya V, Mohammad TA, Nagarajaram HA, Hariram V and Narasimhan C (2012). A low prevalence of MYH7/MYBPC3 mutations among familial hypertrophic cardiomyopathy patients in India. ***Molecular and Cellular Biochemistry*** 360: 373-382.
3. Shain AH, Giacomini CP, Matsukuma K, Karikari CA, Bashyam MD, Hidalgo M, Maitra A and Pollack JR (2012). Convergent structural alterations define SWI/SNF chromatin remodeler as a central tumor suppressive complex in pancreatic cancer. ***Proceedings of the National Academy of Sciences of the USA*** 109: E252-E259.
4. Bashyam MD, Chaudhary AK and Bhat V. The IVS2+837T>G appears to be a relatively common 'rare' β -GLOBIN gene mutation among β -Thalassemia patients in the South Indian state of Karnataka. ***Hemoglobin*** (In press).
5. Bashyam MD, Chaudhary AK, Reddy EC, Reddy V, Acharya V, Nagarajaram HA, Devi ARR, Bashyam L, Dalal AB, Gupta N, Kabra M, Agarwal M, Phadke SR, Tainwala R, Kumar R and Hariharan SV. A founder ectodysplasin A receptor (*EDAR*) mutation results in a high frequency of the autosomal recessive form of hypohidrotic ectodermal dysplasia in India. ***British Journal of Dermatology*** (In press).
6. Muranjan M, Agarwal S, Lahiri K and Bashyam M. Novel biochemical abnormalities and genotype in Farber disease. ***Indian Pediatrics*** (In press).

LABORATORY OF CANCER BIOLOGY

Cellular Senescence and Sirtuin Biology, and Cancer Cervix Progression

Principal Investigator	Gayatri Ramakrishna	Staff Scientist
PhD Students	Shashi Kiran Babul Moni Ram Tarique Anwar Rajendra Angara	Senior Research Fellow Senior Research Fellow Junior Research Fellow Junior Research Fellow (Since Jul. 2011)
Other Members	Nirupama Chatterjee Sapana Singh Rakesh Kulkarni Vineesha Oddi	Technical Officer Post Doctoral Fellow Project Junior Research Fellow Project Junior Research Fellow (Since Jul. 2011)
Collaborators	Nashreen Islam Renu Wadhwa P Uday Kumar	Tejpur University, Assam AIST, Japan NIN, Hyderabad

Objectives

The major focus of our research includes:

1. Understanding the process of cellular senescence;
2. Role of candidate biochemical pathways and genetic/epigenetic changes during cancer cervix progression.

Project 1: Understanding the mechanism of cellular senescence

Telomere attrition is a well known cause for cellular senescence. However, oxidative damage can accelerate ageing leading to premature senescence. In this context, we had earlier proposed a role of wild type Ras in growth arrest (Arvind *et al.* FASEB J. 2005, Bose *et al.* 2011). Infact, senescence is now considered an important growth arrest mechanism in context of neoplastic transformation. We are currently focusing on two main aspects: (a) to understand the paradoxical role of NAD-dependent histone deacetylase *viz.*, SIRT7, in cellular proliferation and senescence and (b) role of redox in accelerating senescence.

Summary of work done until the beginning of this reporting year (upto March 31, 2011)

We had earlier reported that SIRT7 levels decline during the process of replicative senescence and SIRT7 overexpression provides subtle growth advantage. In addition, we reported the use of catalase resistant peroxovanadate compound, as an alternate tool to induce premature cellular senescence.

Details of progress made in the current reporting year (April 1, 2011 - March 31, 2012)

1a. Understanding the biology of SIRT7 in context of senescence

Besides the genetic make-up of the cell, the epigenome plays a crucial role in gene regulation. The epigenome in turn is maintained by acetylation and methylation of the chromatin and its associated proteins. Chromatin modifications are brought about by DNA methyl transferases (DNMTs) and histone deacetylases (HDACs). Amongst the various known histone deacetylases, members of the silent information regulator 2 (*Sir2*) family are conserved from yeast to humans and regulate lifespan in various organisms. Some of the recent reports point to role of Sirtuins as critical regulators at the crossroads between cancer and aging. However, the exact functions of the various isoforms in context of cell proliferation and ageing is still unclear in higher organisms. We undertook a detailed study on the role of Sirtuins and in particular SIRT7 with the following objectives: (a) identification of localization signals of SIRT7, (b) role of SIRT7 if any in cellular senescence. The nuclear cytoplasmic shuttling of SIRT7 is hitherto unknown. Using two different N- terminal specific antibodies we now demonstrate cytoplasmic localization of SIRT7 in human fibroblasts *viz.*, WI38, TIG and MRC5, besides its well known nucleolar niche (Figure 1). Immunoblot analysis indicated presence of a long isoform of SIRT7 (47.5kD) which remains associated with the cytosolic fraction atleast in the fibroblasts and a

short isoform (45kD) associated with the nuclear fraction. In the epithelial cells SIRT7 was exclusively compartmentalized to the nucleoplasm and nucleolar regions. We have now identified the presence of nuclear and nucleolar localization signals in the N- and C- terminal regions of SIRT7. In the previous report, using fibroblast cultures we had shown that SIRT7 levels decline following replicative senescence. Intriguingly, we now report loss of nucleolar SIRT7 during replicative senescence in primary fibroblasts (TIG, WI38). Interestingly, overexpression of SIRT7 in fibroblasts prevented stress induced senescence by adriamycin when treated at lower doses.

1b. Role of SIRT1 in cervical neoplasia

Recent studies point to a close connection between cancer and ageing. Cellular senescence when initiated early in cancerous cells results in growth suppression due to permanent growth arrest. However, the role of human Sirtuin isoforms in malignancies and cellular senescence is still controversial. We therefore designed a study to evaluate the correlation of SIRT1 expression with proliferation marker Ki-67, and growth arrest/senescence marker p27, during cervical cancer progression. The expression was evaluated by immunohistochemistry in 70 formalin fixed archival human cervical samples: normal/ASCUS (N=20), preneoplastic squamous intraepithelial lesions (SIL N=20) and invasive squamous cell carcinoma

(SCC, N=30 samples). The intraepithelial lesions and SCC cases were positive for human papilloma virus as detected by in-situ hybridization. The SIRT1 expression was either absent or feeble in cytoplasm of normal/ASCUS cervical epithelium, while a progressive increase in its expression was noted in 65% of preneoplastic lesions (SIL). Intriguingly, the invasive carcinoma showed heterogeneous pattern for both expression and localization of SIRT1: ranging from negative to strong expression levels and mixed localization pattern in cytoplasm only or both in nucleus and cytoplasm. The growth arrest/senescence marker p27 showed elevated level of expression in SIL cases compared to SCC (75%). Interestingly, the increased nucleocytoplasmic expression pattern of SIRT1 correlated well with the increased expression of p27 in the intraepithelial preneoplastic lesion. In conclusion, our results suggest activation of growth suppressive pathways by SIRT1-p27 regulation, atleast in the preneoplastic lesions of cancer cervix which may help retard its progression to invasive cancer.

1c. Chemical tools which change the cellular redox states to study premature senescence

In continuation with the previous studies on Sirtuins and ageing, we are also trying to establish cell culture systems to induce premature senescence so as to study various biochemical and cellular changes associated with the process of cellular

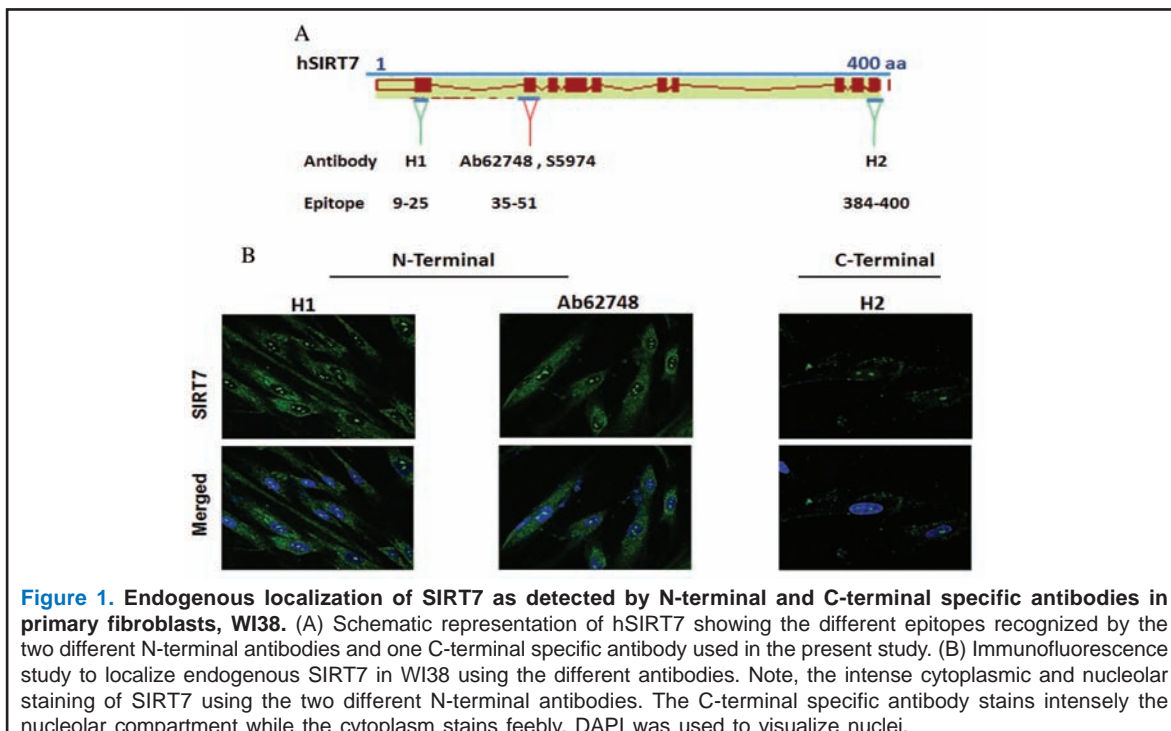

Figure 1. Endogenous localization of SIRT7 as detected by N-terminal and C-terminal specific antibodies in primary fibroblasts, WI38. (A) Schematic representation of hSIRT7 showing the different epitopes recognized by the two different N-terminal antibodies and one C-terminal specific antibody used in the present study. (B) Immunofluorescence study to localize endogenous SIRT7 in WI38 using the different antibodies. Note, the intense cytoplasmic and nucleolar staining of SIRT7 using the two different N-terminal antibodies. The C-terminal specific antibody stains intensely the nucleolar compartment while the cytoplasm stains feebly. DAPI was used to visualize nuclei.

ageing. Treatment of cells with a variety of cytotoxic agents usually at sub-lethal doses can induce stress induced premature senescence (SIPS). H_2O_2 is the most preferred oxidant for studying SIPS and is also considered a unifying ageing mediator. H_2O_2 is rapidly degraded as cells as are well equipped with catalase and glutathione peroxidase systems, hence very high concentrations and long duration of H_2O_2 treatment is needed to induce features of SIPS. Intriguingly, H_2O_2 forms a stable peroxy-complex with orthovanadate, diperoxovanadate (DPV), at pH 7.0, and its peroxy groups are relatively slowly degraded by catalase. In this context we had earlier shown that DPV can act as a good oxidant because of an active and stable peroxy-group, and can substitute for H_2O_2 mediated SIPS at much lower concentrations. In continuation with this work we are now utilizing polymeric peroxovanadate which are also able to induce SIPS. The polymeric peroxovanadate induce cytoskeletal changes including activation of the small GTPase, Rac-1. The role of Rac1-NADPH oxidase system in accelerating the process of senescence is

currently being investigated. Our findings suggest that inorganic peroxides act as an alternate and more efficient tool in studying various cellular effects such as cytoskeletal changes and cellular senescence because of its definitive faster response as compared to H_2O_2 .

Project 2: Pathways in cancer cervix progression

Cervical cancer is a leading cause of mortality among women especially in rural India. Our research group's current focus is on: cancer cervix prevention strategies in rural population and role of candidate biochemical pathways and genetic/epigenetic changes during cancer cervix progression. In this respect we undertook an initiative with the following objectives: (a) the prevalence and genotype distribution of high risk HPV types in cervical specimens collected from women residing in rural set up of Medchal Mandal in Andhra Pradesh (collaboration with Mediciti group) and (b) role of serine/threonine phosphatase, calcineurin in cervical cancer.

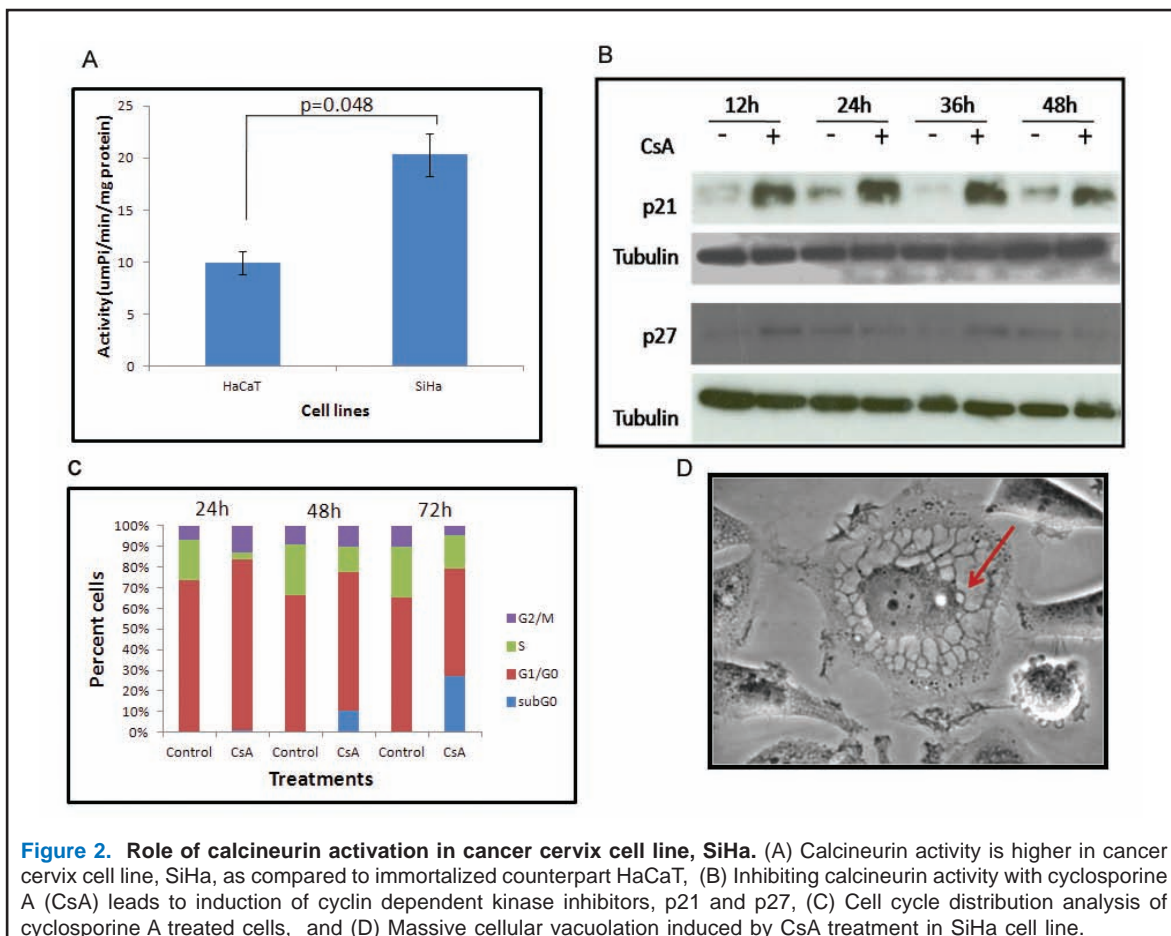

Figure 2. Role of calcineurin activation in cancer cervix cell line, SiHa. (A) Calcineurin activity is higher in cancer cervix cell line, SiHa, as compared to immortalized counterpart HaCaT, (B) Inhibiting calcineurin activity with cyclosporine A (CsA) leads to induction of cyclin dependent kinase inhibitors, p21 and p27, (C) Cell cycle distribution analysis of cyclosporine A treated cells, and (D) Massive cellular vacuolation induced by CsA treatment in SiHa cell line.

Details of progress made in the current reporting year (April 1, 2011 - March 31, 2012)

Role of calcineurin pathway in cancer cervix progression and inhibition of calcineurin results in non-apoptotic cell death pathway

Calcium (Ca^{2+}) has been known for long as an almost universal intracellular messenger, controlling a diverse range of cellular processes, such as gene transcription, cell proliferation and cell death. Calcium signaling is mediated through many signal transduction cascades involving calcium interacting proteins and one such important signaling event is activation of protein phosphatase calcineurin and its downstream effector NFAT (Nuclear Factor Activated in T cells). The role of calcineurin signaling is well established in immune cells, cardiac cells and certain neuronal cells. However, there is still a lacuna in understanding of calcineurin mediated pathways with regard to other epithelial cell types. An attempt is being made to understand the role of calcineurin-NFAT network in context of neoplasia with the following objectives: (a) role of calcineurin activated pathways in cervical cancer cell lines and (b) impact of pharmacological inhibitor of calcineurin viz., cyclosporine A, on growth of cancer cervix cell lines viz., Hela and SiHa. Our results indicate a significant increase in activity of calcineurin in cervical cancer cell line (SiHa) as

compared to its immortalized cell counterpart, HaCaT (Figure 2). The HPV infected cancer cervix cell lines showed a significant upregulation of NFAT-DNA binding activity. To test if calcineurin inhibition results in growth inhibition in cervical cancer cell lines, we used cyclosporine A (CsA) a well known immunosuppressant and pharmacological inhibitor of calcineurin. Indeed, CsA inhibited the growth and foci formation in SiHa cells and serendipitously we made an unusual observation that cyclosporine-A treatment leads to massive cellular vacuolation leading to a non-apoptotic cell death pathway.

Publications

1. Bose S, Sakhuja P, Bezawada L, Agarwal AK, Kazim NS, Khan LA, Sarin SK and Ramakrishna G (2011). Hepatocellular carcinoma with persistent hepatitis B virus infection shows unusual downregulation of Ras expression and differential response to Ras mediated signaling. *Journal of Gastroenterology and Hepatology* 26: 135-144.
2. Chatterjee N, Kiran S, Ram BM, Islam N, Ramasarma T and Ramakrishna G (2011). Diperoxovanadate can substitute for H_2O_2 at much lower concentration in inducing features of premature cellular senescence in mouse fibroblasts (NIH3T3). *Mechanisms of Ageing and Development* 132: 230-239.

LABORATORY OF COMPUTATIONAL AND FUNCTIONAL GENOMICS

Computational and Functional Genomics of Microbial Pathogens

Principal Investigator	Akash Ranjan	Staff Scientist
PhD Students	Jamshaid Ali Rohan Misra Bhavik Sawhney Ajit Roy Suhail Yousuf Abhishek Kumar	Senior Research Fellow Senior Research Fellow Senior Research Fellow Senior Research Fellow Senior Research Fellow Junior Research Fellow (Since Jan. 2012)
Other Members	T Shashi Rekha G Srujana	DBT Research Associate Project Junior Research Fellow (Since Dec. 2011)
Collaborators	Regine Hengge Lothar H Wieler Astrid Lewin Niyaz Ahmed	Freie University, Germany Freie University, Germany Robert Koch Institute, Germany University of Hyderabad, Hyderabad

Project I: Genome analysis and functional characterization of the genomes of microbial organisms

1. Characterization of the promoter and transcription factor binding sites in *Mycobacterium tuberculosis*

There are thirteen sigma factors encoded in the genome of *M. tuberculosis*, which regulate gene expression. Most promoters, however, have not been successfully classified to their relevant sigma factor.

Objective

1. To elucidate the promoter context of transcription factors.

A machine learning approach was applied to the problem of promoter prediction in *M. tuberculosis*. A gold standard data set of experimentally verified mycobacterial promoters was constructed, with the negative dataset consisting of coding sequences. Several substitution schemes were tested, and a six digit binary substitution proved the most effective. Various models were constructed in WEKA and were graded on the basis of their Receiver Operator Characteristic (ROC) values. The Naive Bayesian algorithm performed best, with an ROC of 0.853. The evaluation of this model is enumerated in Table 1.

	TP Rate	FP Rate	Precision	Recall	F-Measure	ROC Area	Class
Weighted	0.83	0.26	0.75	0.83	0.79	0.85	Promoter
	0.74	0.17	0.83	0.74	0.78	0.85	Negative
Average	0.78	0.21	0.79	0.78	0.78	0.85	

Table 1. Results of the Naive Bayesian model

Summary of the work done until the beginning of this reporting year (upto March 31, 2011)

A database of putative *M. tuberculosis* promoters was constructed using the already published consensus sequences of sigma factors. Binding sites of the IdeR repressor were used to generate putative binding sites using PredictRegulon.

Details of progress made in the current reporting year (April 1, 2011 – March 31, 2012)

2. Characterization and functional studies on FadR like proteins from *M. tuberculosis*

GntR family of transcription regulators plays a wide range of roles in cellular physiology. Initially characterized in *Bacillus subtilis*, this family has been studied in many other organisms. However this family remains poorly studied in mycobacteria. Hence, we initiated the characterization of few members of this family from *M. tuberculosis*. One

of the members of this family, Rv0494, is a GntR like protein predicted to be a member of FadR family. Since FadR members from other organisms have been shown to play vital functions in cellular physiology, we wanted to characterize this protein in mycobacteria.

Objectives

1. Expression of GntR as recombinant protein;
2. Identification of transcription factor binding site;
3. Promoter characterization;
4. Target gene identification;
5. Identification of effector molecules.

Details of progress made in the current reporting year (April 1, 2011 – March 31, 2012)

During this period of work we cloned *rv0494* gene in pET23a vector. The protein was expressed, the homogeneity of which was checked on SDS PAGE. We have shown that Rv0494 is present in dimer form in solution. The binding site of Rv0494 was predicted using computational approach, and it was localized near the start codon in the form of a five base pair long palindrome. This predicted binding site was verified using electrophoretic mobility shift assay. Similar sites were found out in the whole genome of *M. tuberculosis* and these sites were verified for their interaction with Rv0494, we have also shown that long chain fatty acyl

coli that is not present in non-pathogenic strains. Several open reading frames are present within this locus, including one that was identified as *slyA*. It was inferred from the study that the pathogenic strains of *E. coli* have two *slyA* like genes. The first *slyA* gene is located at 37.6 min. on the chromosome. The second *slyA* is a homologous gene, ECs3594, whose initial identification was based on an annotation of the *rpoS-mutS* region sequence from *E. coli* O157:H7. This gene was later identified as a different gene and was renamed as *hosA*. Through comparative amino acid analysis it has been shown that HosA protein belongs to MarR family. Our study aims to understand the structural, biophysical, and functional characterization of the HosA protein. The results of this study will provide insight into the role and importance of this protein uniquely present in pathogenic *E. coli*.

Objectives

1. Expression and purification of HosA;
2. Determination of biochemical and biophysical properties of recombinant HosA protein;
3. Structural study of the recombinant HosA protein;
4. Determination of consensus nucleotide sequence recognised by HosA;
5. Identification and characterization of the HosA regulon.

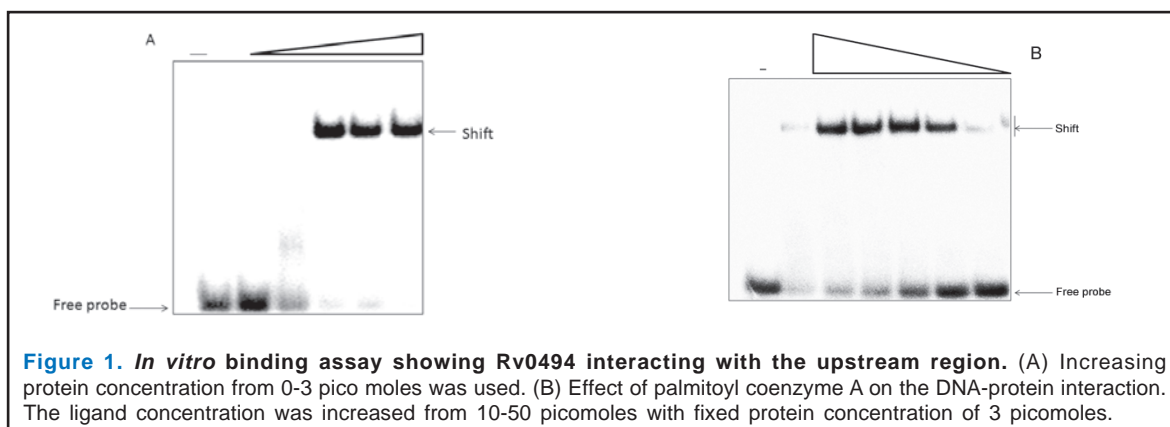

coenzyme A molecules inhibit the protein-DNA interaction, however no effect on this interaction was observed in case of short and medium chain fatty acyl coenzyme A (Figure 1).

3. Structural and functional studies of HosA, a MarR like protein from pathogenic *Escherichia coli*

A novel 2.9-kb insertion sequence is located at the 32 terminus of *rpoS* in pathogenic *Escherichia*

Details of progress made in the current reporting year (April 1, 2011 – March 31, 2012)

The *hosA* gene was cloned and expressed in pET21b (+) vector. The purification of recombinant HosA was done using Ni-NTA affinity chromatography. The purity of the protein was checked by 12% SDS-PAGE and has been shown to form a dimer through gel filtration chromatography using a Superdex 75 column (Figure 2). The purified protein was shown to bind to the

upstream region of the gene for flagellar hook protein *fljC* (Figure 3). Hence it is being considered to regulate the motility in pathogenic strains.

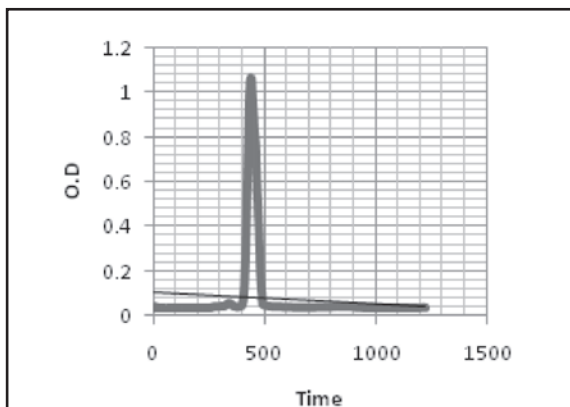

Figure 2. Gel Exclusion chromatography of HosA protein. (Dimer fraction showing the peak at Molecular weight 34kDa, Markers not shown).

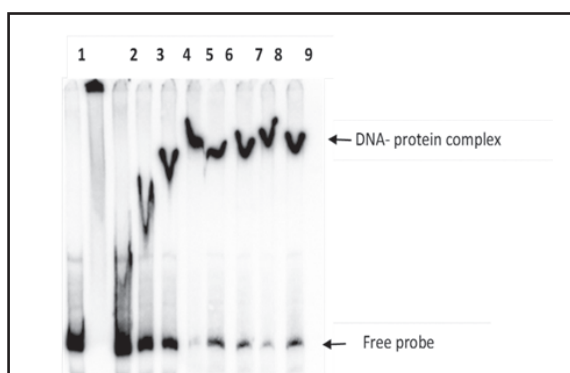

Figure 3. Electrophoretic mobility shift assay (EMSA) (Lane 1 - Free probe, Lane 2 - 0.2 μ M of HosA, Lane 3 - 0.4 μ M of HosA, Lane 4 - 0.8 μ M of HosA, Lane 5 - 1.6 μ M of HosA, Lane 6 - 3.2 μ M of HosA, Lane 7 - 4 μ M of HosA, Lane 8 - 5 μ M of HosA, Lane 9 - 6 μ M of HosA).

Project 2: Genome analysis and functional characterization of *Plasmodium falciparum*

1. An improved method of classification for the intronic and exonic sequences of the apicomplexan genomes

Apicomplexa is a phylum comprising of organisms, which cause several infectious/parasitic diseases in human as well as animals. This phylum consists of genomes, with a demarcation in the AT-content of the coding and noncoding regions, which can be explored further for better classification.

Objective

1. To develop a better method of classification for the intronic and exonic sequences.

Summary of the work done until the beginning of this reporting year (upto March 31, 2011)

Dinucleotide analysis of the coding and noncoding regions of *P. falciparum* exhibits a significant demarcation in their correlation values with the noncoding regions having higher correlations than the coding.

Details of progress made in the current reporting year (April 1, 2011 – March 31, 2012)

We have obtained the experimentally validated exonic and intronic sequences for *P. falciparum* 3D7. The datasets were divided into training (66%) and test (33%) sets and different classifiers were applied using Weka tool (version 3.7.5). The best model generated on the training set was with Random Forest classifier (with 10-fold cross-validation), that was further used for evaluating the test set. We have observed that the test data was evaluated, with a significant ROC value of 0.89 (exons and introns) and a precision of 0.919 (exons) and 0.934 (introns) (Table 2).

Class	TP rate	FP rate	Precision	ROC Area
Exon	0.985	0.294	0.919	0.89
Intron	0.706	0.015	0.934	0.8

Table 2. Evaluation summary of the test set obtained for *P. falciparum* 3D7 using the Random Forest classifier

2. Role of multiple Acyl CoA binding protein paralogs in *P. falciparum*

Acyl-coenzyme A binding proteins (ACBPs) are a family of 86 to 103 residues (~10 kD) proteins with conserved amino acid sequences. There are experimental evidences from diverse sources suggesting their role in modulation of fatty acid biosynthesis, regulation of the intracellular acyl-CoA pool size and many more basic metabolic processes. Knockout/down studies in *Trypanosoma brucei* and HeLa cell lines have proved that ACBP is essential.

Objective

1. To study the binding preferences of all Pf ACBPs for different ligands

Summary of the work done until the beginning of this reporting year (upto March 31, 2011)

We have cloned and expressed all the four ACBPs as histidine-tagged recombinant proteins and purified them by Ni-NTA affinity chromatography. The ACBPs were further purified by gel filtration on a Superdex-75 column.

Details of progress made in the current reporting year (April 1, 2011 – March 31, 2012)

ACBPs are highly conserved even in a highly diverged eukaryote like *P. falciparum*. We hypothesized that there should be some additional function of ACBP in *P. falciparum* apart from binding to acyl CoAs. It is a well known fact that the lipid contents of normal and infected RBCs are different from each other. The maximum expression stage of ACBP is merozoite in which these lipid changes are observed. We wanted to know whether Pf ACBP has anything to do with lipid changes in merozoite stage or not. We checked the binding of Pf ACBPs with phospholipids and diacylglycerols in addition to different acyl CoAs using Protein Lipid Overlay assay, a technique similar to western blot used for detecting protein-lipid interactions. Next we took fluorescence spectra in presence of these molecules and observed that they quench ACBP fluorescence (data not shown).

3. Functional genomic studies of unannotated proteins in *P. falciparum* tRNA modification pathway in *P. falciparum*

tRNA act as an adaptor molecule in protein translation that ensures decoding of the successive codons in the messenger RNA on the ribosome, thus facilitating synthesis of a protein corresponding to that mRNA molecule. To attain a stable structure and perform the important function, tRNA undergoes extensive post transcriptional modifications, of which the conversion of adenosine to inosine at the wobble position facilitates the recognition of the three different nucleotides of an amino acid. *P. falciparum* tRNAs which undergoes modification at the wobble position from A to I were identified. In *P. falciparum* this enzymatic modification of adenosine to inosine is catalyzed by Adenosine deaminase acting on tRNA molecule; ADAT 2 (PF13_0259) and ADAT3 (PFL0230w) respectively.

Objectives

1. To identify amino acid codons, which do not have cognate tRNA molecules in *P. falciparum* and within this pool identify the tRNA molecules which have A to I modification;
2. To determine the enzyme/s involved and study their individual role in binding and editing.

Details of progress made in the current reporting year (April 1, 2011 – March 31, 2012)

It was observed that different tRNA species undergo A to I modification to varying degrees. Interestingly, it was further observed that such modifications at anticodon of tRNA was invariably accomplished by modification of C to U at one position upstream of the first base of anticodon. Also, both ADAT2 and ADAT3 were homogenously expressed from bacterial expression system and it was observed that ADAT3 plays an important role in binding tRNA molecules (Figure 4).

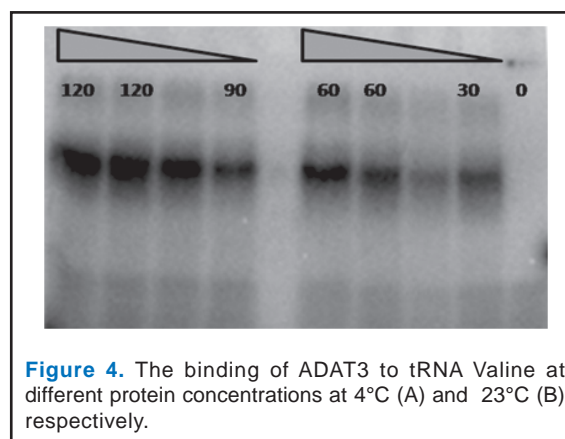

Publication

1. Ali J, Paila U and Ranjan A (2011). ApicoAlign: An alignment and sequence search tool for apicomplexan proteins. *BMC Genomics* 12 (Suppl. 3): S6.

LABORATORY OF TRANSCRIPTION

Mechanism of Transcription Termination and Antitermination in *Escherichia coli*

Principal Investigator	Ranjan Sen	Staff Scientist
PhD Students	Ghazala Muteeb Amitabh Ranjan Rajesh Kumar Saurabh Mishra Mohd Zuhaib Qayyum V Vishalini	Senior Research Fellow Senior Research Fellow Senior Research Fellow Senior Research Fellow Junior Research Fellow Junior Research Fellow
Other Members	Debashis Dey Rajeswari Hosammani Savita Sharma Sapna Godavarthi Shalini Mohan Radhika Kunamneni M Pallavi	Post Doctoral Fellow Post Doctoral Fellow (Since Jul. 2011) Post Doctoral Fellow (Since Dec. 2011) Technical Officer I Project Assistant (Till Jan. 2012) Project Assistant (Since Jun. 2011) Project Assistant (Since Nov. 2011)
Collaborators	Udayaditya Sen V Nagaraja	SINP, Kolkata IISc, Bangalore

Objectives

Transcription must terminate at the end of each operon. In *E. coli*, the end of 50% of operons consist of an intrinsic termination signal that codes for a hairpin followed by a U-rich stretch in mRNA. Rest of the operons do not have any signature sequence and it is possible that termination of these operons depends on a factor called Rho. On the other hand, these termination signals can be overcome in response to certain types of modifications in the elongation complex and this process is called antitermination. The mechanism of these termination and antitermination processes is still not very clear and offers an exciting subject for study. In our laboratory, studies in the following areas are in progress.

1. Mechanism of action of transcription termination factor, Rho;
2. Molecular basis of Rho-NusG interaction;
3. Mechanism of transcription antitermination by N protein at Rho-dependent terminators;
4. Mechanism of action of transcription antitermination of Rho-dependent termination by an anti-rho factor *Psu*;
5. Physiological significance of Rho dependent termination.

Summary of the work done until the beginning of this reporting year (upto March 31, 2011)

1. We made a detailed *in vitro* characterization of the nascent RNA binding properties of Rho and established that loading onto RNA is prerequisite for Rho to perform the termination function (Kalyani *et al.*, J. Mol. Biol., 2011).
2. We made significant progress in establishing the existence of *in vivo* kinetic coupling between the two molecular motors, Rho and RNA polymerase using different Rho, NusG and RNAP mutants.

Details of progress made in the current reporting year (April 1, 2011 - March 31, 2012)

Project 1: Suppression of *in vivo* Rho-dependent transcription termination defects: Evidence for kinetically controlled steps (Shashni *et al.*, Microbiology, 2012)

The conventional model of Rho-dependent transcription termination in bacteria requires a "kinetic coupling" between the elongation complex and the translocating Rho on the nascent mRNA. This model has been recently challenged by a radical view, wherein Rho binds to the elongating RNA polymerase prior to loading onto the mRNA. This view questions the relevance of the kinetic coupling which was proposed from an observation

of the suppression of a Rho-mutant (*rho201*) by a slow-elongating RNA polymerase. The generality of this concept has never been tested. Using growth assays, micro-array analyses and reporter based transcription termination assays *in vivo*, we showed that slowing down of the transcription elongation rate suppressed the termination defects of five Rho mutants, three NusG mutants defective for Rho-binding and the defects caused by the two Rho-inhibitors, Psu and Bicyclomycin. These results established the generality of the existence of kinetic coupling in *in vivo* Rho-dependent termination which also strongly suggests that Rho translocates along the RNA and does not piggy-back the elongation complex *in vivo*. Furthermore, these results indicated that one of the major roles of NusG in *in vivo* Rho-dependent termination is to enhance the RNA-release speed from the elongation complex.

Project 2: A multipronged strategy of an antiterminator protein to overcome Rho-dependent transcription termination (manuscript submitted)

Rho-dependent transcription termination in bacteria has evolved to prevent gene expression from the DNA injected by bacteriophages. Lambdoid phages have designed transcription antitermination systems to overcome this Rho action. The

antiterminator protein N has three interacting regions which interact 1) with the mRNA, 2) with NusA and 3) with the RNAP. Here we show that N uses all these interaction modules to overcome Rho action. N and Rho co-occupy their overlapping binding sites on the nascent RNA (the *nut* site) and this configuration slows down the rate of ATP hydrolysis as well as the rate of RNA release by Rho from the elongation complex (EC). N-RNAP interaction is not too important for this Rho inactivation process near/at the *nut* site. This interaction becomes essential when the EC moves away from the *nut* site. From the unusual NusA-dependence property of a Rho mutant E134K, a suppressor of N, we deduced that the N-NusA complex in the antitermination machinery reduces the efficiency of Rho by removing NusA from the termination pathway. As NusA is a major component of the all the antitermination systems, we propose that “NusA-scavenging” is a universal mechanism for the antiterminators to overcome the termination signals (Figure 1).

Project 3: Molecular basis of inhibition of Rho-dependent transcription termination by a bacteriophage capsid protein

The 21kDa bacteriophage P4 capsid protein has a moonlighting activity as an inhibitor of the transcription terminator, Rho. It inhibits Rho by

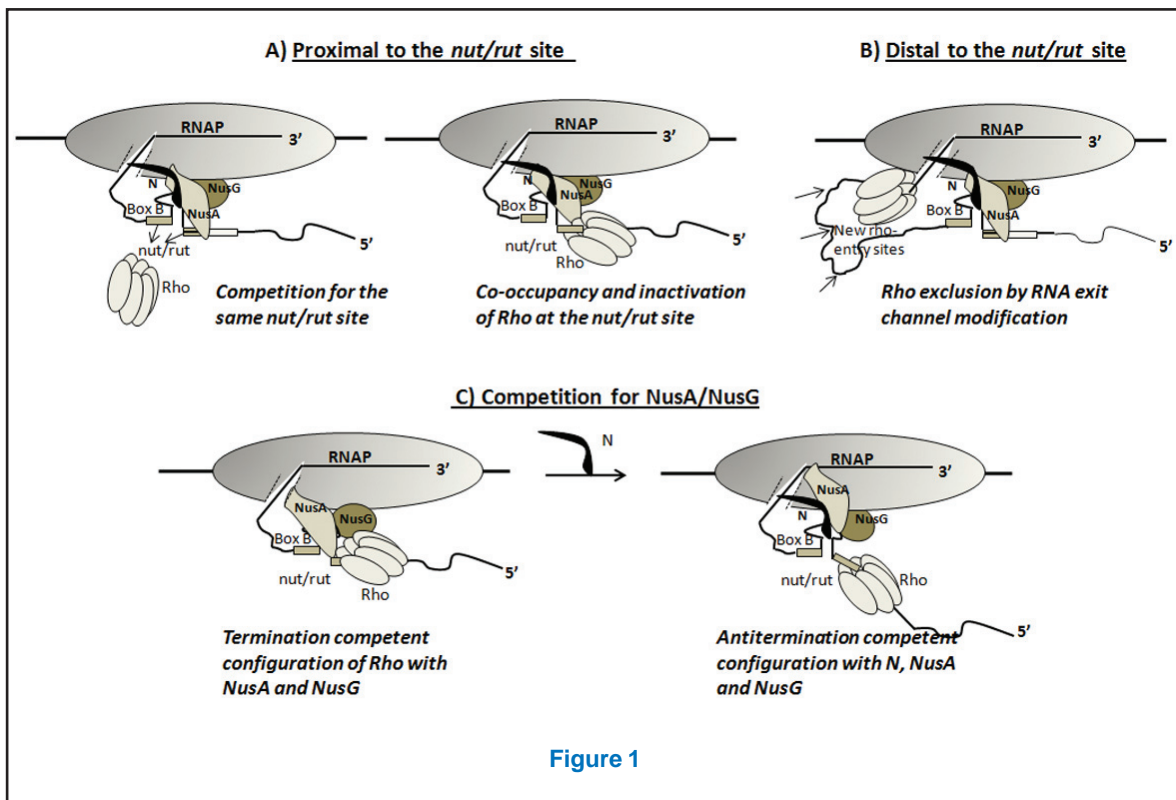
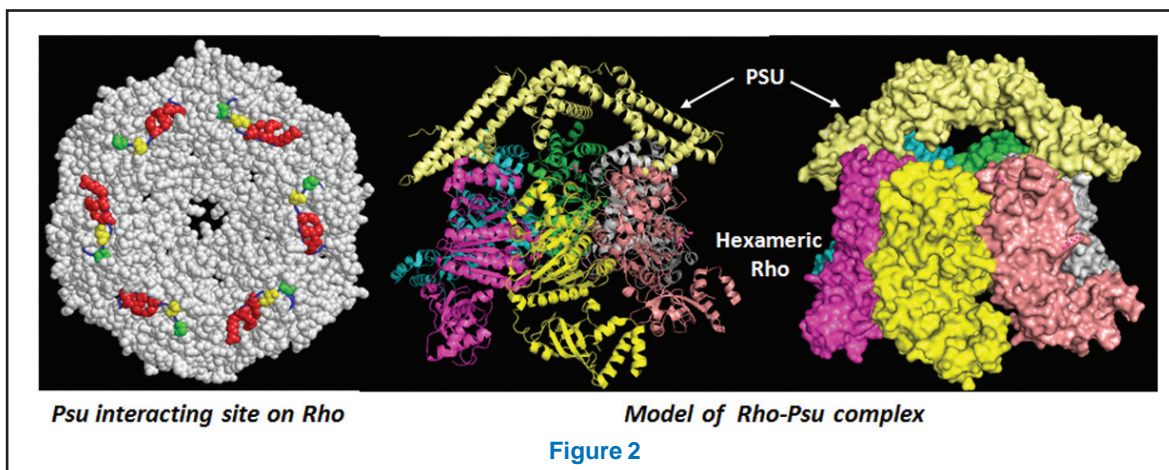

Figure 1

forming a specific complex. The interaction surface of Psu on Rho is not known. Here by using suppressor genetics, cross-linking, Fe-BABE cleavage and site-specific mutagenesis we identified that a disordered looped region between 139-153 amino acids of Rho constitute the interaction surface for Psu. Based on these results and the crystal structures of Rho and Psu, we have proposed the structural model of Rho-Psu complex. In this model each of the monomers of the V-shaped Psu dimer interact with the two diagonally opposite subunits of Rho. This nature of complex formation explains the structural basis of inhibition of the translocase activity of Rho by Psu (Figure 2). The homology models of Rho proteins from several pathogenic bacteria revealed the conservation of this Psu-docking site which led us also to propose that Psu may function as an inhibitor of these Rho proteins.

Publications

1. Chalissery J, Muteeb G, Nisha CK, Mohan S, Jisha V and Sen R (2011). Interaction surface of the transcription terminator Rho required to form a complex with the C-terminal domain of the antiterminator NusG. **Journal of Molecular Biology** 405: 49-64.
2. Kalyani BS, Muteeb G, Qayyum MZ and Sen R (2011). Interaction with the nascent RNA is a pre-requisite for the recruitment of Rho to the transcription elongation complex *in vitro*. **Journal of Molecular Biology** 413: 548-560.
3. Swapna G, Chakraborty A, Kumari V, Sen R and Nagaraja V (2011). Mutations in β' subunit of *E. coli* RNA polymerase perturb the activator polymerase functional interaction required for promoter clearance. **Molecular Microbiology** 80: 1169-1185.



Future plans

The following projects are being and will be pursued in our lab in the next one year. i) Role of NusA in Rho-dependent termination. ii) Importance of Rho-RNA interactions *in vivo*. iii) Mechanism of NusG mediated stimulation of Rho. iv) Characterization of predicted Rho-binding proteins.

4. Shashni R, Mishra S, Kalayani BS and Sen R. Suppression of *in vivo* Rho-dependent transcription termination defects: Evidence for kinetically controlled steps. **Microbiology** (In press).

LABORATORY OF CELL SIGNALLING

Investigating the Role of Inositol Pyrophosphates in Eukaryotic Cell Physiology

Principal Investigator	Rashna Bhandari	Staff Scientist & WT-DBT India Alliance Senior Fellow
PhD Students	Swarna Gowri Thota Rathan Singh Jadav Manasa VL Chanduri Aushaq Bashir Malla	Senior Research Fellow Senior Research Fellow Senior Research Fellow Junior Research Fellow
Other Members	L Padmavathi Ruth Manorama Ravoori Dharmika Kumar Somadri Ghosh CP Unnikannan Sayak Bhattacharya	Scientist B Technical Assistant Project Senior Research Fellow Project Junior Research Fellow Project Junior Research Fellow IUSSTF RISE Intern (Oct. 2011-Feb. 2012)
Collaborators	Satish Kumar Sagar Sengupta Nagaraj Balasubramanian	CCMB, Hyderabad NII, Delhi IISER, Pune

Objectives

Inositol pyrophosphates are derivatives of inositol that contain pyrophosphate or diphosphate moieties in addition to monophosphates. They include diphosphoinositol pentakisphosphate (PP-IP₅, or IP₇) and bis-diphosphoinositol tetrakisphosphate ([PP]₂-IP₄ or IP₈), which are implicated in diverse biological functions, including vesicular trafficking, apoptosis, telomere length maintenance and osmotic regulation. We have earlier demonstrated that the beta phosphate group of inositol pyrophosphates can be transferred to pre-phosphorylated serine residues on proteins to form pyrophosphoserine. Pyrophosphorylation occurs on several proteins within the cell, including proteins involved in ribosome biogenesis and vesicular trafficking. 5PP-IP₅ (IP₇) is synthesised from inositol hexakisphosphate (IP₆) and ATP by IP₆ kinases, three isoforms of which are present in mammals (IP6K1, IP6K2 and IP6K3). IP6K1 knockout mice display low body weight compared with wild type mice, low insulin levels and defective spermatogenesis.

Our aim is to understand the biochemical link between protein pyrophosphorylation and cellular phenomena regulated by inositol pyrophosphates. We utilise *S. cerevisiae*, mammalian cell lines, and knockout mouse strains as model systems to investigate the signalling and metabolic pathways that are altered when inositol pyrophosphate levels

are perturbed. In particular, we focus on the following objectives:

1. Examine the role of inositol pyrophosphates in yeast ribosome biogenesis;
2. Understand the cellular functions of mammalian inositol hexakisphosphate kinase 1;
3. Study the role of inositol pyrophosphates in whole animal physiology.

Summary of work done until the beginning of this reporting year (upto March 31, 2011)

We observed that *S. cerevisiae* strains lacking the IP₆ kinase *kcs1* display slow growth, sensitivity towards antibiotics that inhibit ribosome function, have reduced levels of ribosomes, and lower rates of protein synthesis. Steady state levels of 35S precursor rRNA, and the incorporation of radiolabelled uracil into rRNA are substantially lowered in *kcs1Δ* yeast. Run-on transcription analysis demonstrated that the rate of rRNA transcription is reduced. Together, our data suggested that inositol pyrophosphates regulate ribosome biogenesis in yeast by participating in RNA polymerase I mediated transcription of rRNA.

To understand the role of IP₇ in the regulation of mammalian physiology, we use mouse embryonic fibroblasts (MEFs) derived from IP6K1 knockout (KO) and wild type (WT) mice as a model system. IP6K1 KO MEFs have 70% reduced levels of IP₇ compared with WT MEFs. Analysis of gene

expression microarray data comparing WT and IP6K1 KO MEFs predicted that regulation of the actin cytoskeleton is altered in KO MEFs. We observed an altered pattern of polarised migration and slower spreading in IP6K1 KO MEFs plated on fibronectin coated surfaces, confirming that there is indeed a perturbation in actin cytoskeleton dynamics in fibroblasts lacking IP6K1.

Details of progress made in the current reporting year (April 1, 2011 - March 31, 2012)

Project 1: Regulation of yeast ribosome biogenesis by IP₇

To determine the mechanism by which IP₇ regulates rRNA transcription, we have examined the sequences of 14 subunits of yeast RNA polymerase I core complex and 9 accessory factors, and identified 5 proteins that contain acidic serine sequence motifs that may be pyrophosphorylated by IP₇ (Figure 1). We expressed these proteins as GST-fusions in *S. cerevisiae*, and tested phosphorylation of the purified recombinant proteins using radiolabelled IP₇ *in vitro*. RPA34, RPA43 and RPA190, subunits of RNA polymerase I, are phosphorylated by IP₇. We are currently conducting site directed mutagenesis to identify the site of IP₇-mediated pyrophosphorylation, and determine its effect on protein function.

Project 2: Cellular functions of mammalian inositol hexakisphosphate kinase 1 (IP6K1): Role of inositol pyrophosphates in homologous DNA recombination

In addition to examining signalling pathways altered

in IP6K1 KO MEFs that were revealed by gene expression microarray analysis, we have begun to study specific cellular functions of inositol pyrophosphates that may be biochemically linked with protein pyrophosphorylation. Specifically, we are examining the role of inositol pyrophosphates in the regulation of homologous DNA recombination in mammalian cells.

Several lines of evidence suggest that IP₆ kinases may regulate DNA recombination. *KCS1* was originally identified in a screen for suppressors of a hyper-recombination phenotype observed in *pkc1Δ* yeast, suggesting that IP₇ may promote DNA recombination. To examine whether this phenomenon is conserved in mammals, we analysed WT and IP6K1^{-/-} MEFs for their response to DNA damaging agents that cause double strand breaks.

Treatment of MEFs with hydroxyurea (HU) leads to replication stress, inducing double strand DNA breaks and triggering repair via homologous recombination (HR). We monitored HU treated wild type and knockout MEFs for cell cycle arrest and release during a 12 h period following drug removal. IP6K1^{-/-} cells arrest at the G1/S boundary to the same extent as IP6K1^{+/+} cells, indicating that checkpoint activation following DNA damage is intact in the absence of IP6K1 (Figure 2A). However, fewer knockout cells enter the S phase after HU removal. Conversely, a higher number of knockout MEFs are present in the hypodiploid (<G0) population, representing non-viable cells, after a 12 h recovery period. The RecQ family helicase BLM participates in HR-mediated DNA repair. BLM

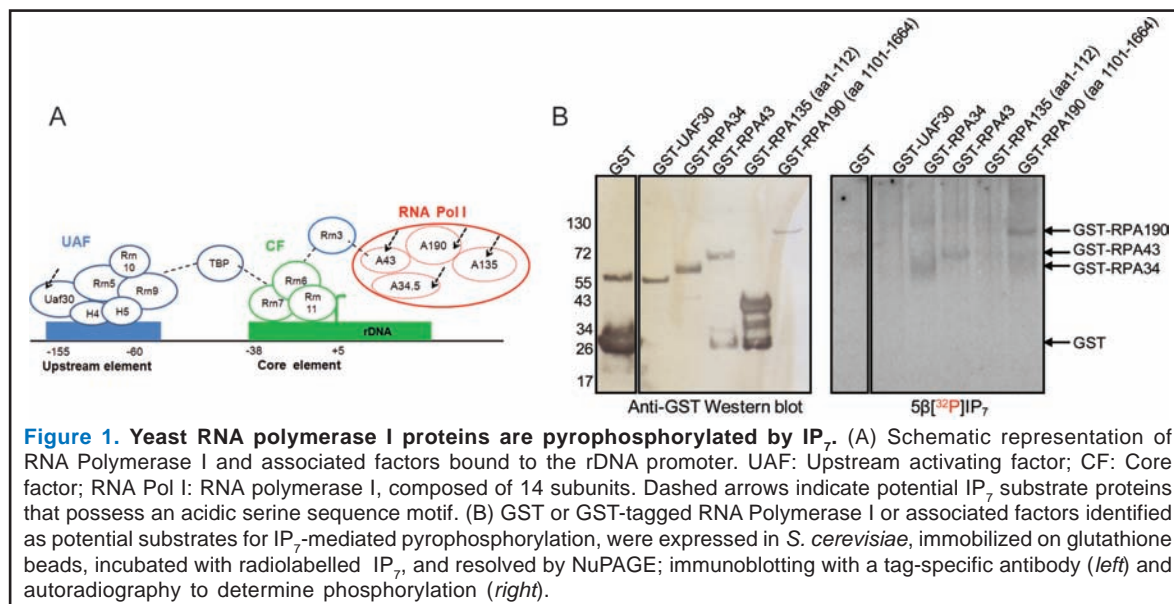

containing foci marking the sites of DNA damage were observed by confocal fluorescence microscopy (Figure 2B). These foci persist 6 h after HU removal in knockout, but not in wild type MEFs, indicating that HR-mediated DNA repair is initiated but incomplete in cells lacking IP6K1 (Figure 2B, C). To determine whether the role of IP6K1 in HR is dependent upon its inositol pyrophosphate synthesis activity, we stably expressed active and catalytically inactive forms of IP6K1 in IP6K1^{-/-} MEFs. BLM foci persist after a 6 h recovery period following HU removal in cells expressing inactive IP6K1, but the number of foci were reduced in cells expressing active IP6K1

(Figure 2D), implying that inositol pyrophosphate synthesis by IP6K1 is required for HR-mediated repair of damaged DNA.

Data presented here reveal a role for inositol pyrophosphates synthesised by IP6K1 in HR-mediated repair of double strand breaks in mammalian cells. At a mechanistic level, it is clear that IP6K1 is not required for cell cycle checkpoint activation or the initiation of HR following DNA damage, but participates in the successful completion of HR. Inositol pyrophosphates may regulate this process by binding or pyrophosphorylating one or more proteins involved

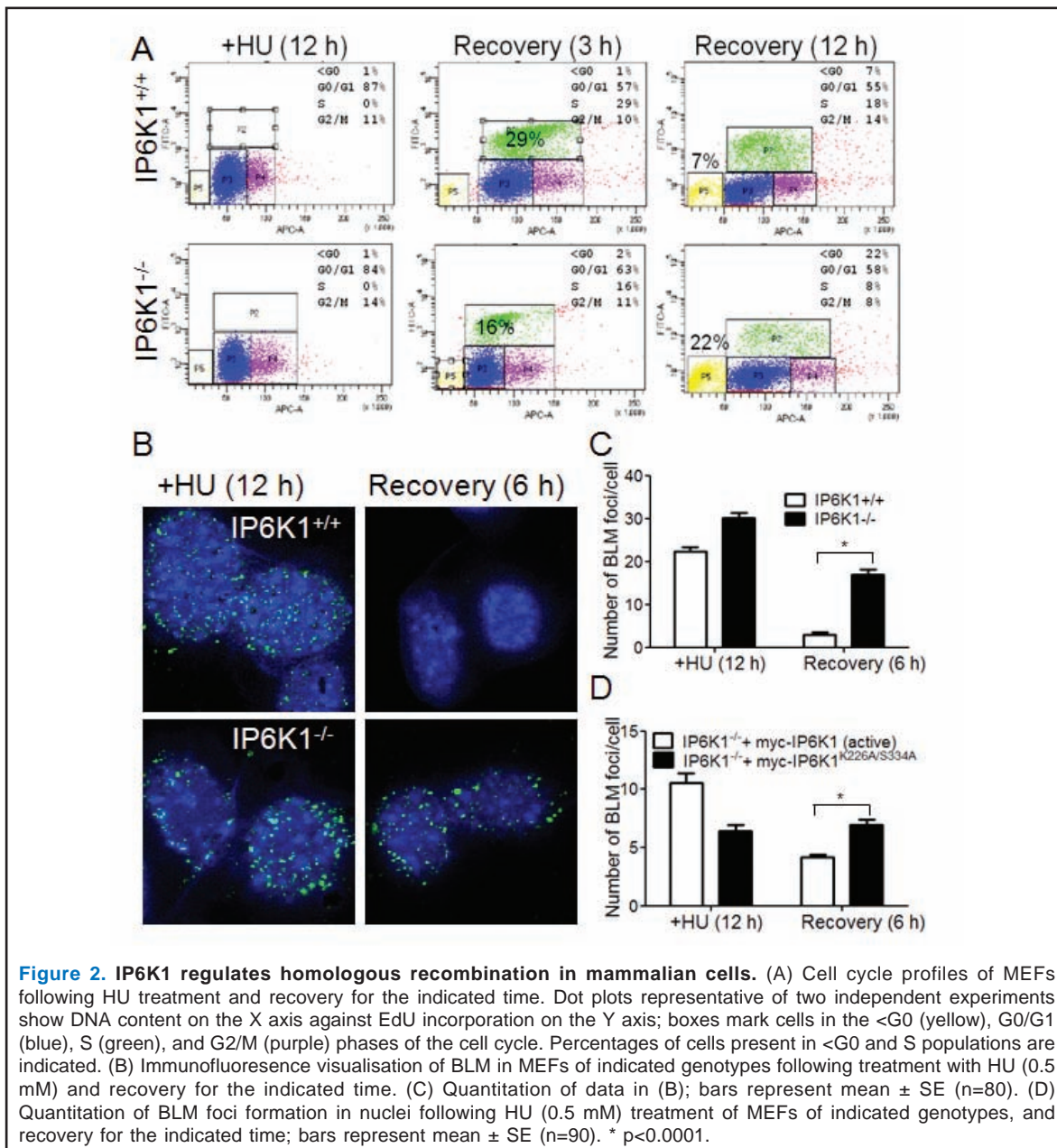

in HR. In the near future we will focus on identifying molecular targets that mediate the involvement of IP6K1 in HR. A manuscript outlining this work is currently in preparation.

Project 3: Physiological role of IP₇ in mice: Regulation of mouse spermiogenesis by IP6K1

This is a new activity. This project aims to understand the role played by IP6K1 in spermatogenesis. We have established a colony of IP6K1 heterozygous mice and are breeding them to obtain wild type and knockout litter-mates. We have earlier shown that IP6K1 knockout male mice are infertile and have no mature spermatozoa in the epididymis (Bhandari *et al.*, Proc. Natl. Acad. Sci., USA, 2008). Flow cytometry analysis of germ cells isolated from seminiferous tubules of wild type

and IP6K1^{-/-} mouse testes revealed that the loss of IP6K1 does not affect meiosis (Figure 3A). Round and elongated spermatids are present in IP6K1^{-/-} mice testes, although the fraction of elongated spermatids is marginally reduced in IP6K1^{-/-} compared with wild type testes. However, elongated spermatids isolated from IP6K1 knockout testes have misshapen heads, and absent or bent tails (Figure 3B). This may explain why there is no spermiation in IP6K1^{-/-} mouse testes, which is reflected in the absence of mature spermatozoa in the epididymis. We are presently characterising this defect in greater detail, and plan to investigate whether the spermiogenesis defect in IP6K1^{-/-} male mice is linked to the role of IP₇ in regulating actin cytoskeleton dynamics and DNA repair.

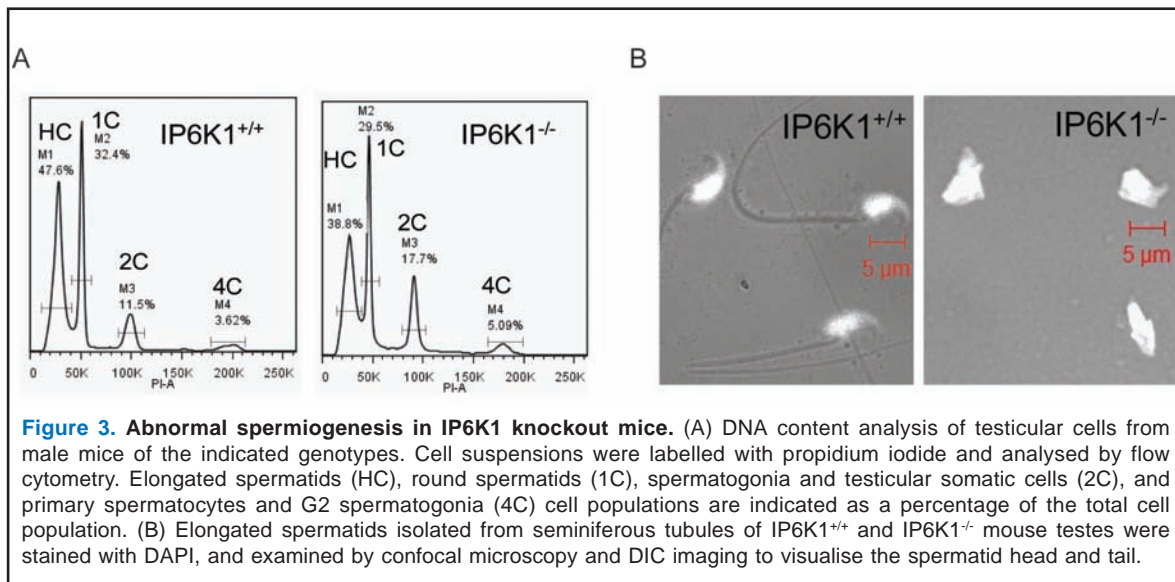

Figure 3. Abnormal spermiogenesis in IP6K1 knockout mice. (A) DNA content analysis of testicular cells from male mice of the indicated genotypes. Cell suspensions were labelled with propidium iodide and analysed by flow cytometry. Elongated spermatids (HC), round spermatids (1C), spermatogonia and testicular somatic cells (2C), and primary spermatocytes and G2 spermatogonia (4C) cell populations are indicated as a percentage of the total cell population. (B) Elongated spermatids isolated from seminiferous tubules of IP6K1^{+/+} and IP6K1^{-/-} mouse testes were stained with DAPI, and examined by confocal microscopy and DIC imaging to visualise the spermatid head and tail.

LABORATORY OF PLANT MICROBE INTERACTION

Understanding Virulence Mechanisms of *Xanthomonas* Plant Pathogens and Interaction with Host Plants

Principal Investigator	Subhadeep Chatterjee	Staff Scientist
PhD Students	Rikky Rai Sheo Shankar Pandey Raj Kumar Verma Tanmoy Sarkar	Senior Research Fellow Senior Research Fellow Junior Research Fellow Junior Research Fellow (Since Aug. 2011)
Other Members	Binod Bihari Pradhan Narasimha Rao N Sree Gowrinadh Javvadi L Santhosh Kumar	Technical Officer DBT Research Associate (Till Apr. 2012) Project Junior Research Fellow Project Junior Research Fellow (Since Sep. 2011)

Objectives

1. Identification and characterization of virulence factors of *Xanthomonas*;
2. Role of cell-cell communication in *Xanthomonas* colonization and virulence;
3. Function of protein secretion system in *Xanthomonas* and role in virulence;
4. Role of PAMP in pathogen recognition and plant defense response.

Summary of work done until the beginning of this reporting year (upto March 31, 2011)

We are trying to understand the virulence mechanisms of important *Xanthomonas* pathogens like, *Xanthomonas campestris* pv. *campestris* (Xcc; a pathogen of crucifers), *Xanthomonas oryzae* pv. *oryzae* & *Xanthomonas oryzae* pv. *oryzicola* (Xoo, Xola; pathogens of rice) and *Xanthomonas axonopodis* pv. *citri* (Xac; pathogen of citrus).

To understand the role of DSF in the virulence of *Xanthomonas oryzae* pv. *oryzae*, we have made mutants unable to synthesize DSF (*rpfF* mutants) and deficient in DSF sensing. DSF deficient *rpfF* mutant exhibited significant reduction in the biofilm thickness as compare to the wild type and mutant with the complementing clone. We are presently studying in more detail the dynamics of biofilm formation in Xoo using different cell-cell signaling mutants alone or in combination to see the contribution of these in this process.

Details of the progress made in the current reporting year (April 1, 2011 – March 31, 2012)

Project 1: Role of DSF in virulence of *Xanthomonas oryzae* pv. *oryzae*

In *Xanthomonas oryzae* pv. *oryzae*, the bacterial blight pathogen of rice, a secreted fatty acid signaling molecule known as diffusible signal factor (DSF) is required for virulence and growth on low iron medium. To identify other virulence associated traits that are regulated by DSF in this pathogen, we have performed microarray analysis of transcriptional changes between wild type and DSF deficient mutants of *X. oryzae* pv. *oryzae* (Figure 1). Expression of genes that encode secreted hydrolytic enzymes, motility and chemotaxis functions are negatively regulated by DSF while functions involved in adhesion and biofilm formation are positively regulated. Enzymatic assays for hydrolytic enzymes (Figure 2) as well as assays for chemotaxis, motility, attachment and biofilm formation corroborate these findings (Figure 3). These results demonstrate that in *X. oryzae* pv. *oryzae*, DSF mediated cell-cell signaling coordinates transition from solitary to biofilm lifestyle by promoting expression of attachment functions and negatively regulating expression of motility functions. This is in contrast to *X. campestris* pv. *campestris*, a pathogen of crucifers, wherein the DSF system positively regulates motility functions and negatively regulates biofilm formation. These results indicate that virulence associated functions can be regulated in a completely contrasting fashion by the same signaling system in very closely related bacteria.

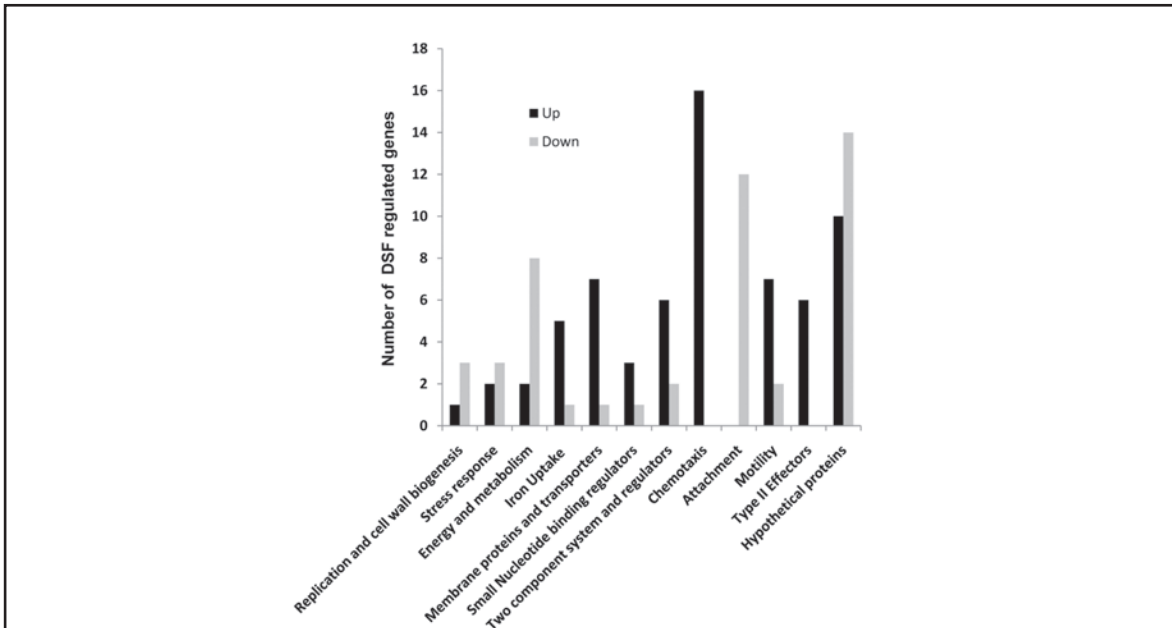

Figure 1. DSF regulates diverse functions in *X. oryzae pv. oryzae*. Functional categorization of DSF regulated genes in *X. oryzae pv. oryzae* based on expression analysis by microarray and Real Time RT-PCR. Values on the Y-axis represent number of up and down regulated genes in the DSF deficient *rpfF* mutant in comparison to the wild type strain for each functional category.

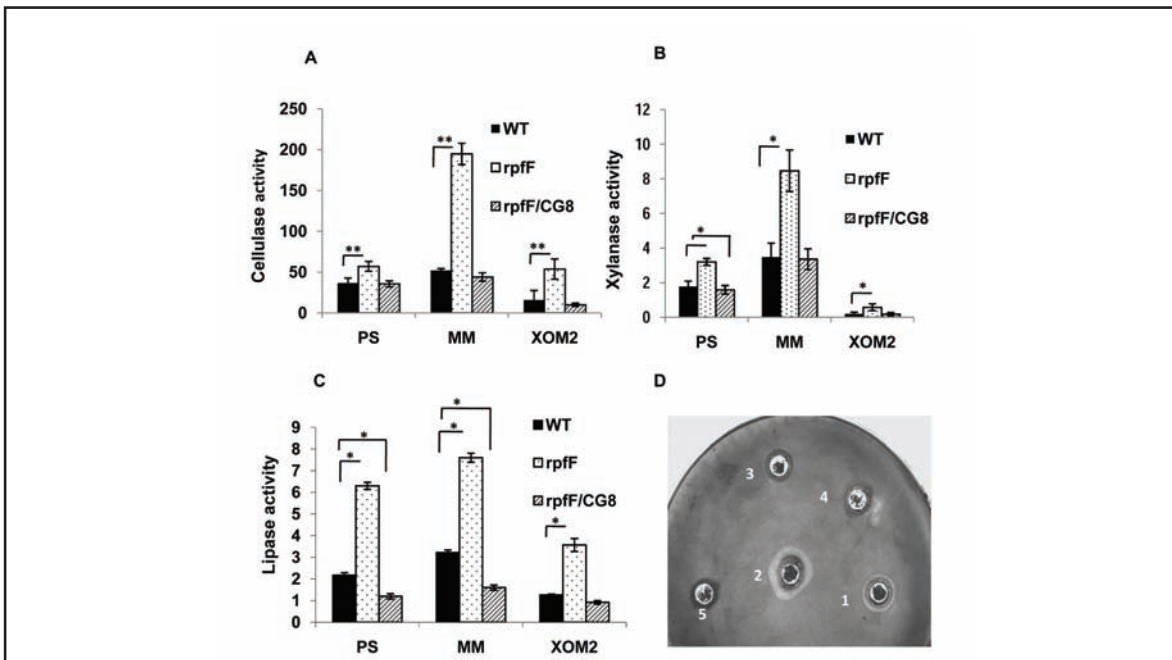
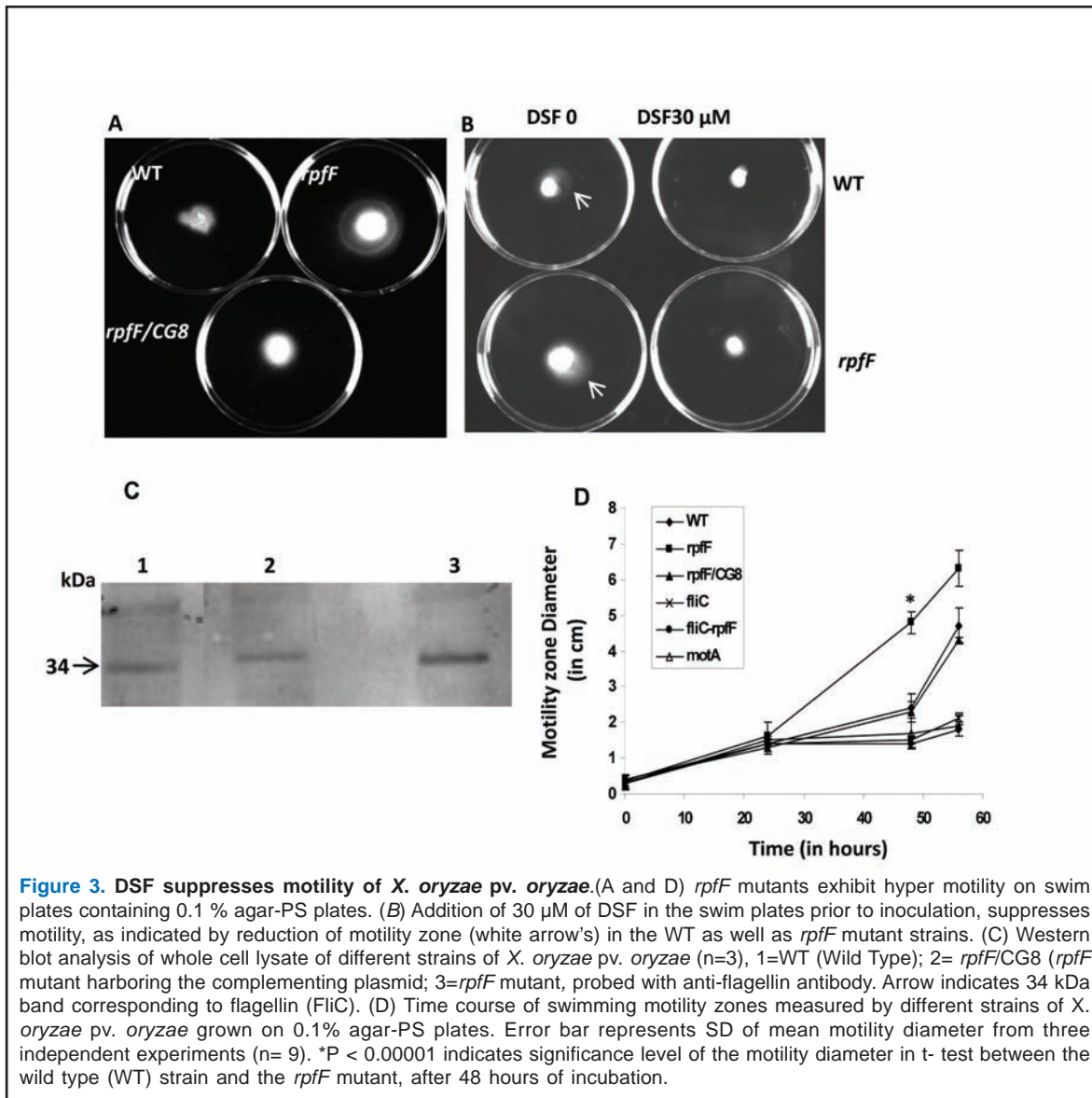

Figure 2. Influence of DSF and growth condition on the synthesis of Type II effectors. (A) Cellulase, (B) xylanase and (C) lipase activities in the culture supernatants of *X. oryzae pv. oryzae* wild type (WT), *rpfF* and *rpfF/CG8* (*rpfF* mutant with the complementing plasmid) strains represented by black, dotted and striped bar's grown to a density of 10^9 cells/ml in rich (PS), Minimal (MM) and XOM2 (media mimicking Type III secretion) medium. (D) Representative picture of plates of CMC-cellulose stained with congo red for cellulase production well assay from culture supernatant of different strains of *X. oryzae pv. oryzae* (1) WT, (2) *rpfF* mutant, (3) *rpfF/CG8* (*rpfF* mutant with the complementing plasmid), (4) *rpfF* mutant supplemented with 30 μ M of DSF and (5) T2SS mutant (Type II Secretion System). Halo zone around the wells indicates cellulase activity. Error bar's represent SD of mean activity from three independent experiments ($n=3$). Statistically significant difference in activity by t- test for cellulase (A) **for p value = or < 0.001; xylanase (B) * for p values = 0.05- 0.01; lipase (C) * for p values = 0.05- 0.01.



We propose a model that elucidates the role of DSF-mediated cell-cell signaling in establishing colonization and subsequent infection in rice leaves by *X. oryzae* pv. *oryzae* (Figure 4). At low DSF levels, which corresponds to low cell densities of *X. oryzae* pv. *oryzae* before it enters rice leaves, chemotaxis and motility is activated. This facilitates *X. oryzae* pv. *oryzae* movement through chemotaxis towards hydathodal exudates. Initially, hypermotility in the absence of high DSF might promote spread of the pathogen in rice xylem vessels. Type II effectors are then released causing hydrolysis of plant cell walls which leads to nutrient release, promoting *X. oryzae* pv. *oryzae* growth. When high cell densities of *X. oryzae* pv. *oryzae* are reached, DSF levels also increase, promoting biofilm

formation by the synthesis of EPS and various adhesions such as XadA and YapH. Production of excess Type II effectors is also suppressed which prevent overgrowth of biofilms, which otherwise would lead to xylem blockage.

Project 2: Understanding the mechanism of biofilm formation and motility and virulence

We have previously isolated a novel adhesin of *Xanthomonas*, XadM, which is required for virulence and biofilm formation. In this study we have further characterize the expression and localization of XadM. Expression studies indicate that XadM is induced inside the plant (*in planta*) and is required for binding of *Xanthomonas oryzae* pv. *oryzae* to extracellular polysaccharide (EPS) and plant cell wall.

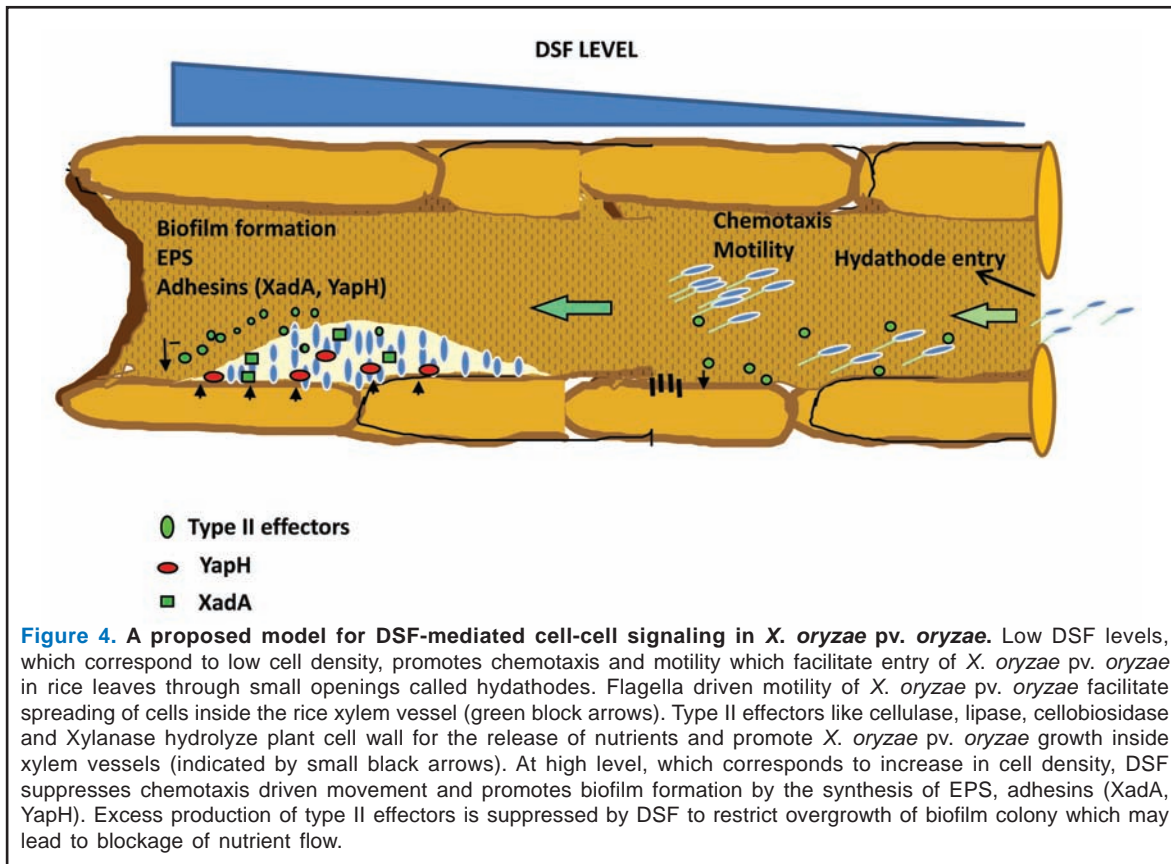

Publications

1. Li YR, Zou HS, Che YZ, Cui YP, Guo W, Zou LF, Chatterjee S, Biddle EM, Yang CH and Chen GY (2011). A novel regulatory role of HrpD6 in regulating *hrp-hrc-hpa* genes in *Xanthomonas oryzae pv. oryzicola*. ***Molecular Plant-Microbe Interactions*** 24: 1086-1101.
2. Almeida RPP, Killiny N, Newman KL, Chatterjee S, Ionescu M and Lindow SE. Contribution of *rpfB* to cell-to-cell signal synthesis, virulence, and vector transmission of *Xylella fastidiosa*. ***Molecular Plant-Microbe Interactions*** (In press).
3. Pradhan BB, Ranjan M and Chatterjee S. XadM, a novel adhesin of *Xanthomonas oryzae pv. oryzae*, exhibits similarity to Rhs family proteins and is required for optimum attachment, biofilm formation and virulence. ***Molecular Plant-Microbe Interactions*** (In press).
4. Rai R, Ranjan M, Pradhan BB and Chatterjee S. Atypical regulation of virulence associated functions by a Diffusible Signal Factor in *Xanthomonas oryzae pv. oryzae*. ***Molecular Plant-Microbe Interactions*** (In press).

LABORATORY OF CELL DEATH & CELL SURVIVAL

Molecular Mechanisms Controlling Cell Life and Death

Principal Investigator	Maddika Subba Reddy	Staff Scientist & WT-DBT India Alliance Intermediate Fellow
PhD Students	Neelam Rani PV Vivek Reddy G Narmadha Reddy Swapnil R Shinde	Junior Research Fellow Junior Research Fellow Junior Research Fellow Junior Research Fellow (Since Aug. 2011)
Other Members	Vimal Pandey K Sridhar J Kiranmai Nanci Rani	Research Associate (Since Aug. 2011) Project Junior Research Fellow Project Junior Research Fellow Technical Assistant
Collaborators	Murali D Bashyam	CDFD, Hyderabad

Objectives

1. To dissect the functional network of phosphatases regulating cell life and death;
2. To understand the role of E3 ubiquitin ligases involved in tumorigenesis.

Summary of work done until the beginning of this reporting year (upto March 31, 2011)

PTEN (phosphatase and tensin homologue deleted on chromosome 10) is a lipid phosphatase, which antagonizes the cellular phosphatidylinositol-3 kinase (PI3K) signalling pathway and a well defined tumor suppressor that plays critical roles in cell survival, proliferation, and cell death. To understand the functional interactome of PTEN, we performed a tandem affinity purification using streptavidin agarose beads and S-protein agarose beads followed by mass spectrometry analysis. Our studies identified WWP2 (HECT-type E3 ubiquitin ligase) as one of the functional interacting partners of PTEN (Maddika *et al.*, Nature Cell Biol. 2011; 13(6):728-33). The interaction of WWP2 and PTEN was confirmed both *in vitro* and in cultured cells by GST-pull down assay and co-immunoprecipitation experiments respectively. We demonstrated that WWP2 promotes PTEN polyubiquitination both *in vivo* and *in vitro*. In addition, knock down of WWP2 leads to an increase in PTEN levels, which correlates with decreased Akt phosphorylation and cell survival. By using a prostate cancer cell line model, we demonstrated that depletion of WWP2 by siRNA reduces cell proliferation, fails to support the anchorage independent growth and reduces tumor

growth in nude mice. Overall in this study, we have identified WWP2 as a novel functional E3 ubiquitin ligase for PTEN phosphatase.

Details of progress made in the current reporting year (April 1, 2011 - March 31, 2012)

Project 1: Studies on the functional interactome of PTEN phosphatase

As PTEN is a very critical tumor suppressor and trivial changes in PTEN levels lead to susceptibility to malignancy, it is essential to define the regulatory mechanisms that control PTEN functions. Several studies have indicated that PTEN is regulated by multiple mechanisms either at the transcriptional or post translational level. PTEN expression is regulated by transcription factors such as p53, PPAR γ and egr-1 at the transcription level, whereas PTEN ubiquitination and phosphorylation regulate its protein levels and activity at the posttranslational level. In our work, we demonstrate that PTEN activity can be regulated through a direct protein-protein interaction.

To elucidate potential regulators of PTEN, we recently performed a tandem affinity purification using PTEN stable cell line and identified several PTEN associated proteins (Maddika *et al.*, Nature Cell Biol. 2011; 13(6):728-33). We found PNUTS as one of the potential PTEN associated proteins. PNUTS (Protein phosphatase-1 nuclear targeting subunit), also called PPP1R10, CAT53 and p99, was originally isolated as a nuclear protein that forms a stable complex with PP1 α and PP1 γ in mammalian cells. PNUTS binds to PP1 and potently decreases the catalytic activity of PP1

towards exogenous substrates such as Retinoblastoma (Rb) protein *in vitro*, and reduced expression of PNUTS in mammalian cells affects cell viability. However, the exact function of PNUTS under normal and disease condition remains to be elucidated.

We demonstrated the interaction of PTEN with PNUTS by immunoprecipitating HEK-293T cell lysates using a PNUTS polyclonal antibody (Figure 1A). We also confirmed the direct interaction of PTEN and PNUTS by using *in vitro* GST-pull down assays. Our deletion mapping analysis suggested that PNUTS via its N-terminal TF2S domain interacts with the C2-domain of PTEN. We further tested whether PTEN and PNUTS co-localize in

the cell. PTEN is mainly localized in the cytoplasm with sparse nuclear localization. Interestingly, expression of full length PNUTS, but not Δ TF2S PNUTS leads to drastic re-localization of PTEN to the nucleus, where it co-localizes with PNUTS (Figure 1B). On the other hand, expression of PNUTS has no effect on PHLPP indicating the specificity of PNUTS-PTEN interaction. Collectively these data suggest that PNUTS sequesters PTEN in the nucleus by directly interacting with PTEN.

To further explore the effect of PNUTS on PTEN access to lipids at the membrane, we tested whether Akt signalling downstream of PTEN is affected when PNUTS levels are modulated in cells. Indeed, knockdown of PNUTS by specific siRNA

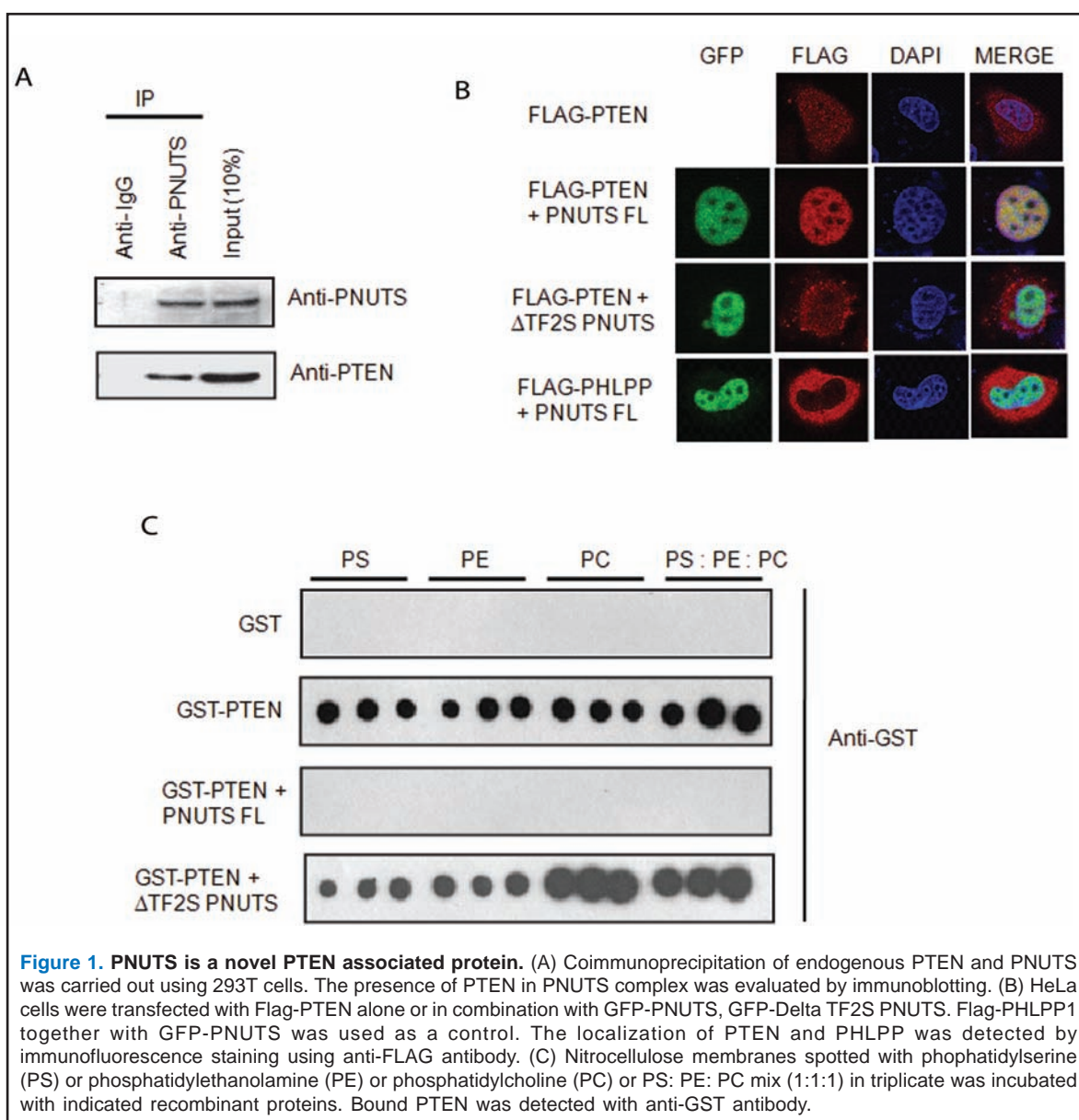

in HeLa cells resulted in decreased Akt phosphorylation (Figure 2A) followed by increased cellular apoptosis in a PTEN dependent manner (Figures 2B). To further test whether PNUTS influences cellular survival and growth and to establish its role as a proto-oncogene, we stably depleted PNUTS with short hairpin RNA (shRNA). Cells expressing PNUTS shRNA showed reduced cell proliferation (Figure 2C) and fail to support anchorage independent growth in soft agar assays (Figure 2D) compared with control shRNA

expressing cells. Conversely, stable expression of full length PNUTS but not Δ TF2S PNUTS in normal BPH1 prostate epithelial cells enhanced the proliferation and the transforming ability of cells. Collectively these results indicate that PNUTS acts as a potential oncogene by sequestering PTEN.

Project 2: Studies on E3 ubiquitin ligases involved in cell survival and proliferation

E3-ubiquitin ligases play a critical role in the final step of the ubiquitination process by recruiting

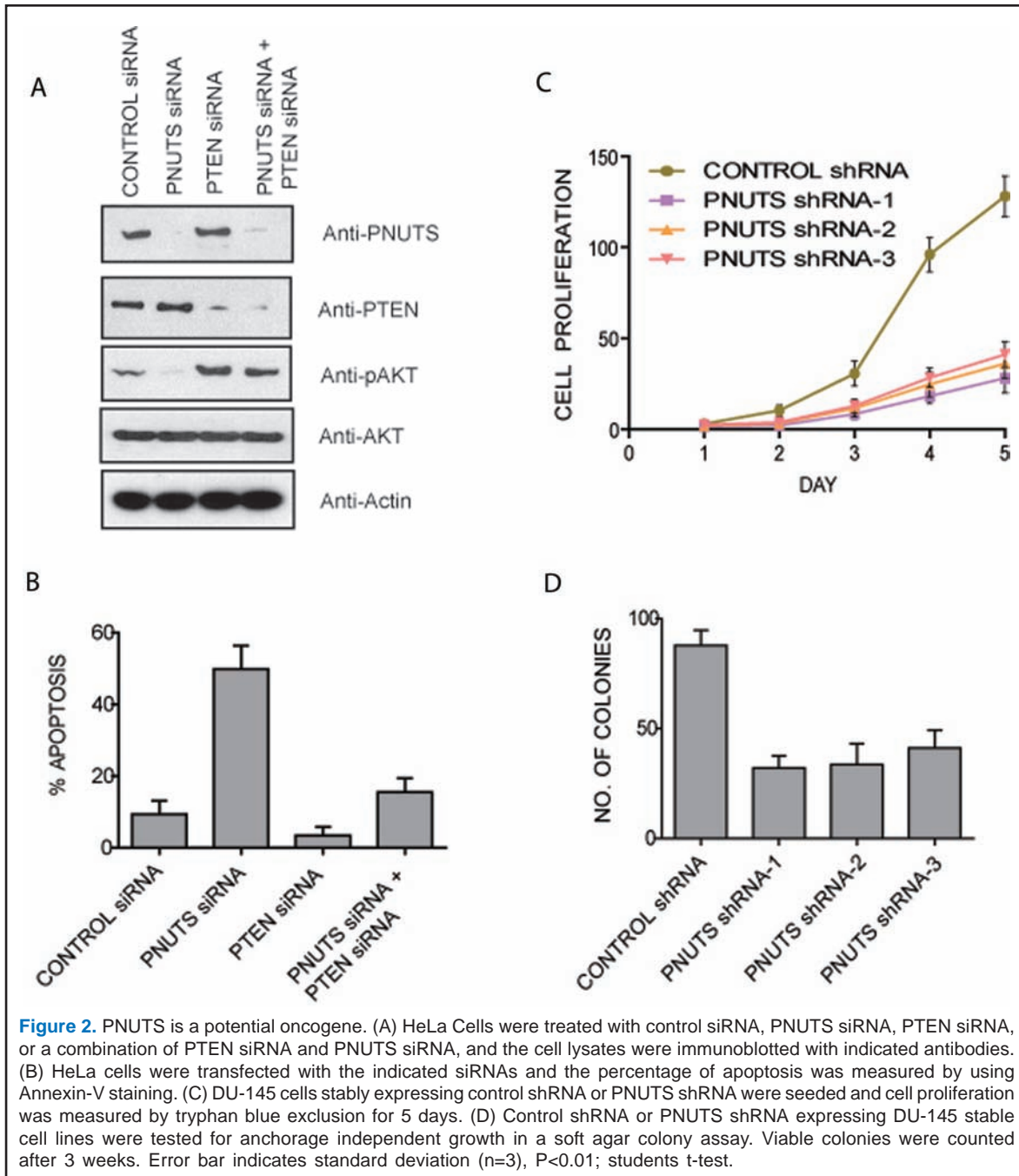

ubiquitin charged E2s, recognizing specific substrates, and mediating, or directly catalyzing, ubiquitin transfer to the substrates. The human ubiquitin system contains nearly 600 ubiquitin ligases of which several of them were classified as tumor suppressors or protooncogenes. In this project, we are interested in identifying the cellular substrates and the regulators for different E3 ligases during cell survival and proliferation. We have isolated interacting partners for HECT E3 ligases such as WWP2, WWP1 and HACE1. We were

able to successfully identify several novel associated proteins for these E3 ligases and are currently studying the functional significance of these newly identified interacting partners in controlling cell survival and proliferation.

Publication

1. Maddika S, Kavela S, Rani N, Palicharla VR, Pokorny JL, Sarkaria JN and Chen J (2011). WWP2 is an E3 ubiquitin ligase for PTEN. ***Nature Cell Biology*** 13: 728-733.

LABORATORY OF DROSOPHILA NEURAL DEVELOPMENT

Understanding Patterning and Development of Central Nervous System
using *Drosophila melanogaster*

Principal Investigator Rohit Joshi

Staff Scientist & WT-DBT India
Alliance Intermediate Fellow

PhD Students Risha Khandelwal
Neha Ghosh

Junior Research Fellow
Junior Research Fellow (Since Feb. 2012)

Other Members P Kalyani
V Sruthakeerthi
Ankush Auradhkar

Technical Officer I
Project Assistant
Project Assistant (Since Nov. 2011)

Objectives

The key objective of the project is to understand how neural progenitor cells attain their positional identity in the developing Central Nervous System (CNS) of an organism, and how this translates into generation of a variety of cell types found in the CNS (as represented in Figure 1). The Hox family of transcription factors are known to play an important role in giving positional identity to the cells and in generation of a variety of cell types along the AP axis of the CNS during development. The molecular basis of this phenomenon is not well investigated. We are interested in understanding the molecular basis of Hox function in patterning the CNS using *Drosophila melanogaster* as our model organism, focusing mainly on early embryonic and late larval stages of development. To this end, the specific aims are

as follows:

1. Understanding the molecular function of Hox gene *Abdominal-A* (*Abd-A*) in larval CNS patterning;
2. Understanding the role of Hox gene *Deformed* (*Dfd*) in patterning of embryonic subesophageal ganglia.

Summary of work done until the beginning of this reporting year (upto March 31, 2011)

1. **Understanding the molecular function of Hox gene *Abdominal-A* (*Abd-A*) in larval CNS patterning**

The abdominal region of the *Drosophila* larval CNS has a lower number of neurons compared to its thoracic counterpart. Hox gene *Abd-A* is known to cause programmed cell death (apoptosis) of neural

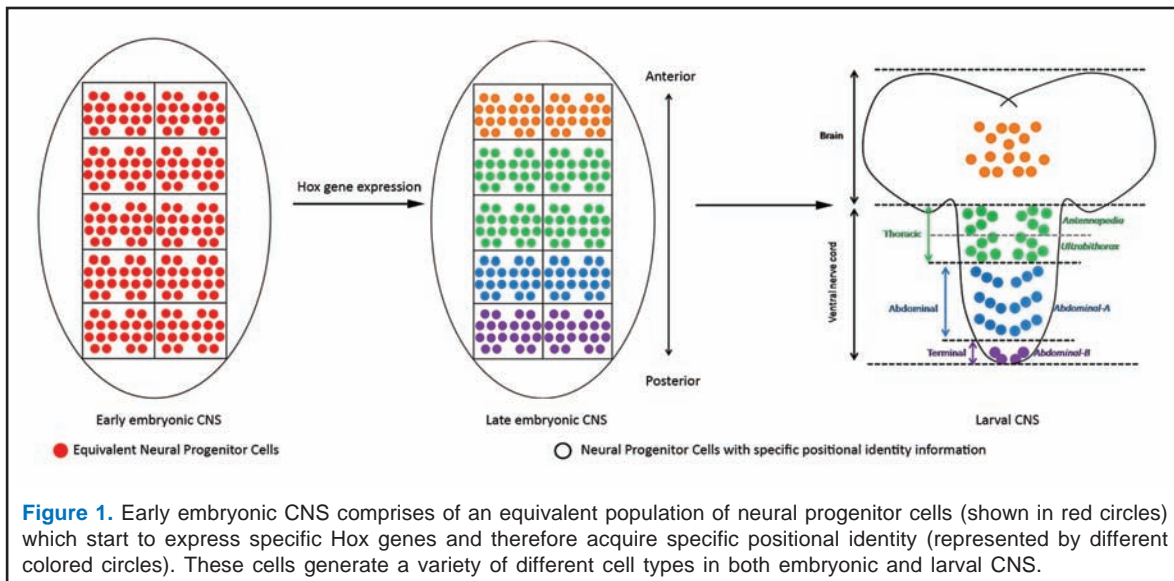

progenitor cells (also called Neuroblasts-Nbs) and therefore limit the number of neurons in the abdominal region of the CNS.

The precise molecular details of how *Abd-A* cause Nb apoptosis are unknown. Genetic evidence suggests a role for a helix-loop-helix transcription factor *Grainyhead (Grh)* along with *Abd-A* in control of this apoptosis. Characterization of the molecular basis of this link is the primary goal of this project. There are three apoptotic genes in *Drosophila* (*hid*, *grim* and *reaper*). A genetic deficiency spanning all the three genes prevents apoptosis of Nbs in the abdominal region of the larval brain. Amongst the three, *reaper (rpr)* was selected for further analysis since a 600bp regulatory region of *rpr* is suggested to express the *rpr* gene in embryonic Nbs. The central hypothesis is that *Abd-A* and *Grh* cause Nb apoptosis through direct activation of *rpr*. A *Drosophila-E. coli* shuttle vector (*pCasPer-nls-lacZ*) with a reporter gene β -galactosidase was used to clone the embryonic Nb specific 600bp *rpr* enhancer to check its expression in larval abdominal Nbs. Transgenic lines were made using this shuttle vector.

2. Role of Hox gene *Deformed (Dfd)* in patterning of embryonic subesophageal ganglia

Hox genes express in the CNS (in neural progenitor cells) in embryonic stages of development (as represented in Figure 1) but how their expression patterns the embryonic nervous system is not well understood. *Deformed (Dfd)* is known to express in the cells of subesophageal ganglion of the embryonic CNS. This project focuses on understanding auto-regulation of *Dfd* in this region and finding out how this helps in giving cells their specific positional identity. This is being done by using a 630bp long auto-regulatory CNS specific enhancer for *Dfd* which recapitulates the expression of *Dfd* gene in the developing embryonic CNS. The 630bp enhancer is suggested (but not conclusively tested) to express in progenitor cells of the CNS and has potential binding sites for *Dfd* and known Hox cofactors like Extradenticle (vertebrate homolog being *Pbx*) and *Hth* (vertebrate homolog being *Meis*). These cofactors are also homeodomain containing transcription factors and their role in autoregulation of *Dfd* gene needs to be tested. A *Drosophila-E.coli* shuttle vector with *pCasPer-nls-lacZ* was used to clone the CNS specific 630bp autoregulatory enhancer of *Dfd*.

Transgenic lines were made to check its expression in specific cell types (especially Nbs) in subesophageal region of the embryonic brain. Simultaneously, protein expression was standardized for *Dfd*, *Exd* and *Hth*.

Details of progress made in the current reporting year (April 1, 2011 - March 31, 2012)

1. Understanding the molecular basis of Hox gene *Abdominal-A (Abd-A)* in larval CNS patterning

A report in early 2011 (Tan *et al.*, Development 2011) conclusively shows that *grim* instead of *rpr* is the gene primarily responsible for abdominal Nb apoptosis during larval stages of development. A systematic genetic analysis using chromosomal deficiency lines narrow down a 23 kb region of the genome which contains the *grim* enhancer responsible for its activation in abdominal Nbs (also called NBRR-Neuroblast Regulatory Region). These results have been helpful in redirecting the research plans and do not significantly affect the course of ongoing research, since the initial hypothesis that *Grh* and *Abd-A* interact together to result in apoptosis of abdominal Nbs is still valid and needs to be tested in context of the Nb specific *grim* enhancer.

Work is ongoing for the identification of the Nb specific *grim* enhancer by a systematic screening of the 23kb NBRR. The region has been divided into 4 overlapping fragments (of 8kb, 10kb, 8 kb and 8kb each) that will be cloned into *pCasPer-nls-lacZ* reporter construct and *enhancer-lacZ* transgenic lines will be screened. These 4 fragments have been amplified by PCR from genomic DNA using region specific primers. The first 8kb fragment has already been cloned into *pCasPer-nls-lacZ* shuttle vector and microinjections are being done for the same. The cloning work is ongoing for the rest of the three fragments. Simultaneously, a genetic approach is being taken to generate smaller deficiencies in the 23kb NBRR to identify the potential Nb specific enhancer of *grim* gene. A transposon line inserted in the beginning of the 2nd fragment (10kb region) is being crossed into a relevant background to be mobilized to cause imprecise excision of the transposon. The deficiencies thus obtained will be screened for their ability to prevent larval abdominal Nbs apoptosis. On identification of the Nb specific functional enhancer of the *grim* gene, *in vitro* and

in vivo experiments will be done to test the directness of Abd-A and Grh input in activation of *grim* to cause abdominal Nb apoptosis.

Since Grh is involved in Nb apoptosis and is not expressed in neuronal progeny refractory to this apoptosis, it is of interest to define *grh* regulation in these cells which keeps *grh* “on” in the Nbs and “off” in the neuronal progeny of Nbs. A 4kb enhancer of *grh* (referred to as *grh4*) is responsible for the neuroblast specific expression of the gene in CNS. This 4kb region of *grh* is divided into 3 parts and being analyzed to identify the minimal enhancer which will recapitulate the expression of the gene in Nbs. All the three fragments have been sub-cloned into *pCasPer-nls-lacZ* and the transgenic lines for fragment 1 and fragment 3 have been generated and are being balanced. These transgenic lines will be screened to check their capacity to drive the expression in Nbs. The functional enhancer for *grh* identified by this method will be used to understand the mechanism responsible for differential expression of *grh* gene in Nbs versus neurons.

2. Role of Hox gene *Deformed* in patterning of embryonic subesophageal ganglia

The 630bp *Dfd* autoregulatory element was scanned for Hox-Exd binding sites and two putative compound binding sites were identified for these two transcription factors. *In vitro* binding studies were done on these binding sites using EMSA and both the binding sites showed binding to Dfd-Exd heterodimer. In order to investigate the *in vivo* relevance of these binding sites, these sites were mutagenized in the 630bp DNA element and these various mutagenized forms of the enhancers have been sub-cloned into the *pCasPer-nls-lacZ* shuttle vector and the transgenic lines are being made for the same. These transgenic lines will be tested for their capacity to activate the reporter β -galactosidase to test the relevance of the binding site and a direct role of these transcription factors in auto-regulation of *Dfd* gene. Reagents are also being generated to test the activity of the *enhancer-lacZ* in background mutants for known Hox cofactors like Exd and Hth.

LABORATORY OF CELL CYCLE REGULATION

Elucidating the Role of Effector Proteins in G1 to S Phase Progression

Principal Investigator	Shweta Tyagi	Staff Scientist & Ramalingswamy Fellow
PhD Students	Aamir Ali Zaffer Ullah Zargar Swathi Chodisetty	Junior Research Fellow Junior Research Fellow Junior Research Fellow (Since Aug. 2011)
Other Members	VN Sailaja G Ashwini Kumar Manjari Mulukutla	Technical Officer II Project Associate (Till Nov. 2011) Project Assistant (Since Feb. 2012)

Objectives

1. Identification of new effector proteins involved in regulation of E2F-responsive promoters;
2. Study of chromatin modifying proteins in cell cycle regulation.

Summary of work done until the beginning of this reporting year (Upto March 31, 2011)

To proliferate, eukaryotic cells have to complete an ordered series of events called the 'cell cycle', which include the faithful replication of their genome and the correct segregation of the two copies generated into two daughter cells upon cell division. A disruption of these events may lead to cell death or oncogenic transformation. The processes of cell cycle, therefore, are carefully regulated. We have previously shown that HCF-1 is an important regulator of G1 to S-phase transition and plays a direct role in the activation of E2F-responsive promoters through the cell-cycle-specific recruitment of the MLL-family of H3K4 histone methyltransferases. While this work has added new effectors to G1 to S-phase transition, how E2Fs affect passage into S phase is still poorly understood. In this project we aim to identify new effector proteins involved in regulation of E2F-responsive promoters and better understand how these effectors influence transcriptional regulation during G1 to S phase progression.

Epigenetic marks such as DNA methylation and histone modifications are either precisely transmitted to the daughter cells or dynamically changed during cell cycle. Indeed, some histone modifications are intimately linked with specific cell-cycle phases. Histone 3 lysine 4 trimethylation is linked to active gene expression, but its precise role in cell cycle regulation is now being uncovered.

We have shown that MLL-family of H3K4 histone methyltransferases is linked to cell cycle regulation by interacting with E2F1. In this project, we are looking at other roles of this chromatin-modifying complex that may influence cell cycle regulation.

Details of the progress made in the current reporting year (April 1, 2011 - March 31, 2012)

Project 1: Identification of new effector proteins involved in regulation of E2F-responsive promoters

A key step in the eukaryotic cell cycle is the G1 to S phase transition and this step is tightly coupled to the transcriptional control of genes involved in growth and DNA replication. In mammalian cells, the E2F family of transcription factors primarily controls this temporal gene expression regulation. After two decades of research, how E2Fs affect passage into S phase is still poorly understood. Here, we aim to identify new effector proteins involved in regulation of E2F-responsive promoters.

We will take a candidate based approach to look for effector proteins. A key methodology in this project is cell synchronization. In order to harvest cells in a particular cell cycle phase, we synchronized Hela cells using double thymidine block and harvested cells every two hours after release into normal media. The DNA content of propidium iodide-stained cells was analyzed by flow-cytometry and the percentage of cells in a particular cell cycle phase was determined. Repeat experiments gave us the time points that we could use to harvest cells in G1/S, S, G2/M, early G1 and late G1 phase (see Figure 1A). We will use the synchronized cells later in the project to look at specific binding of our protein of interest to E2F-responsive promoters using Chromatin immunoprecipitation (ChIP).

In order to assess if our protein of interest associates with E2F-responsive promoters, we will make use of three well-characterized E2F-regulated promoters namely *p107*, *E2F1* and *cyclin A*. As negative control, we will use a region from U2 snRNA gene- U2_C. To initiate our studies, we standardized ChIP for immunoprecipitation against E2F1 and E2F4 antibody followed by qPCR

(Figure 1B). Pre-immune IgG and water were used as negative controls for ChIP and qPCR, or qPCR respectively. Consistent with previous reports, our results showed that both E2F1 and E2F4 bind to p107 promoter in asynchronous cultures. We will now use antibodies specific to our protein of interest to perform ChIP experiments.

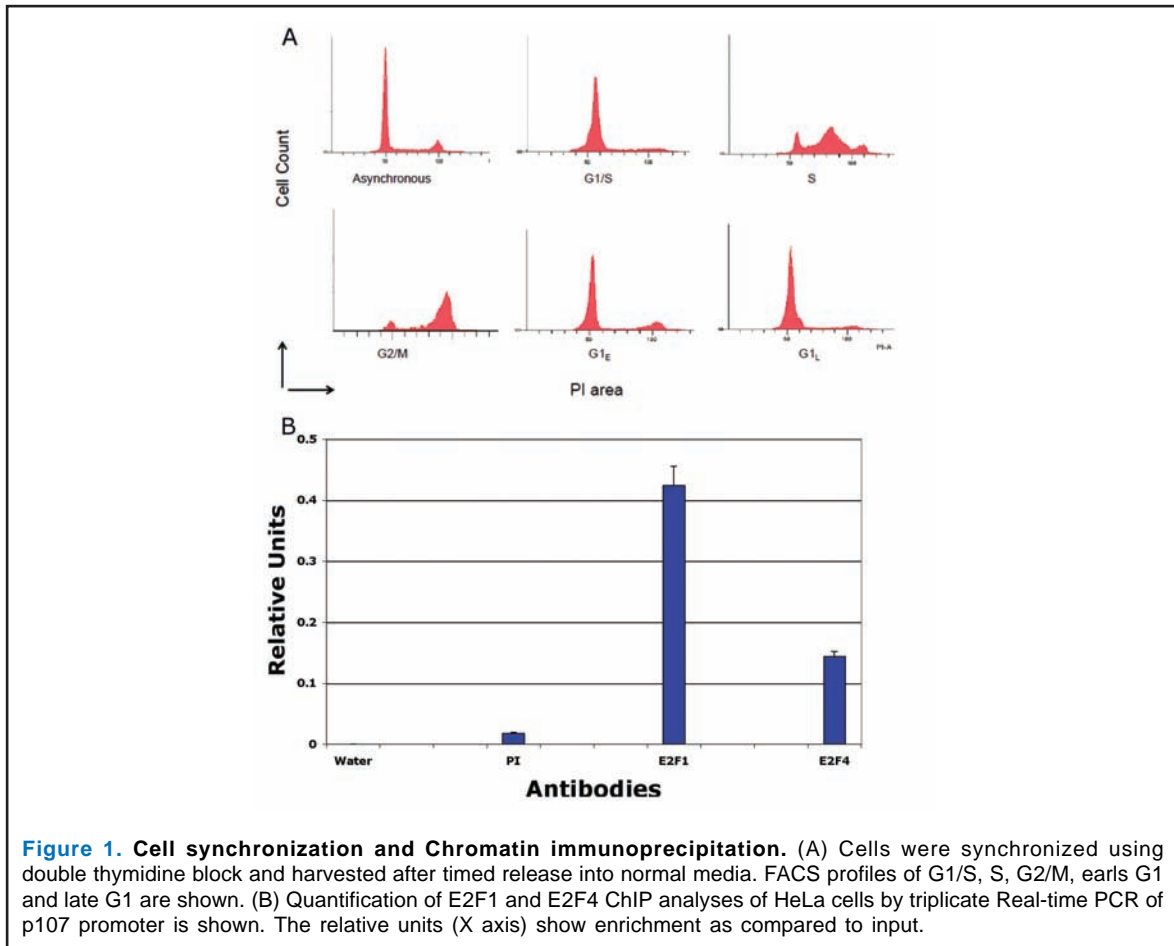

Figure 1. Cell synchronization and Chromatin immunoprecipitation. (A) Cells were synchronized using double thymidine block and harvested after timed release into normal media. FACS profiles of G1/S, S, G2/M, early G1 and late G1 are shown. (B) Quantification of E2F1 and E2F4 ChIP analyses of HeLa cells by triplicate Real-time PCR of p107 promoter is shown. The relative units (X axis) show enrichment as compared to input.

Project 2: Study of chromatin modifying proteins in cell cycle regulation.

To decipher the role of histone 3 lysine 4 trimethylation in cell cycle regulation, we will make use of siRNA to deplete specific members of MLL family of H3K4 HMT. All members of mammalian MLL family form protein complexes with at least three common structural components, RbBP5, Ash2L and WDR5 along with the catalytic subunit that harbors the SET domain (Figure 2A). We have initiated our studies by selectively knocking down WDR5, which is well-characterized and a universal component of H3K4 HMT complexes. To knock

down WDR5, we made use of siRNA pool consisting of four siRNAs specific to WDR5. As a control, we used siRNA directed against *luciferase* gene (*Luc*), which is absent in mammalian cells. These siRNAs were transfected in mammalian cell lines U2OS using a polycationic lipid-based reagent. 72 hours later, we harvested the cells and analyzed them for loss of WDR5 protein by sodium dodecyl sulfate polyacrylamide gel electrophoresis followed by immunoblot. As shown in Figure 2B, we were able to knock down WDR5 efficiently in 72 hours post-transfection. We will now look for cell-cycle specific defects arising due to loss of WDR5 protein.

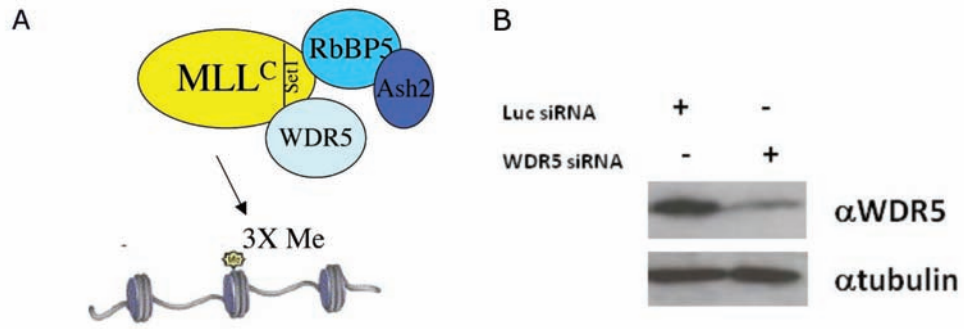

Figure 2. Components of Histone 3 lysine 4 histone methyltransferase (H3K4 HMT). (A) Each Set1 homolog exists as a multi-protein complex containing a minimum of SET domain containing protein and Ash2L, RbBp5 and WDR5 subunits. Together, this complex trimethylates lysine 4 of histone 3. (B) U2OS cells were treated with Luciferase and WDR5 siRNA and harvested 72 hrs later. Whole cell lysate immunoblots stained with WDR5 and tubulin antisera are shown.

अन्य वैज्ञानिक सेवाएँ / सुविधाएँ
Other Scientific Services / Facilities

LABORATORY ANIMAL FACILITY

Faculty Co-ordinators	Rashna Bhandari Sanjeev Khosla	Staff Scientist Staff Scientist
Other Members	Jayant P Hole Suman Komjeti	Officer-in-Charge Technical Assistant

Objectives

1. Establish a Laboratory Animal Facility for CDFD scientists who wish to use rodent models in their research;
2. Maintain inbred and transgenic strains of mice in a controlled environment, as per CPCSEA guidelines;
3. Assist users in procuring rodents for research, and conducting IAEC approved procedures.

Details of progress made in the current reporting year (April 1, 2011 - March 31, 2012)

Although CDFD was established more than 15 years ago, and is now a recognised centre for basic life science research, a laboratory animal facility was not available to its researchers. An animal facility is necessary to support biological research in areas, such as immunology, cancer biology, cell biology, genetics, infectious disease, etc., and enables such research to meet internationally accepted standards. Given CDFD's current geographical constraints, it was not possible to construct a laboratory animal facility in our present temporary campus building. Therefore, it was decided to invite proposals from experienced and reputed companies, operating a laboratory animal facility located in Hyderabad, to provide animal experimentation services to the scientific staff of CDFD.

Based on a two bid tendering system, M/s Vimta Labs Limited, located at Genome Valley, Shameerpet, Hyderabad was selected to provide laboratory animal experimentation services to CDFD. Services provided by M/s Vimta Labs include the provision of 5 rooms suitable for animal experimentation exclusively for CDFD to house at least 500 individually ventilated cages (IVCs) for rodents; common utilities including, animal feed, bedding, cage washing and sterilization; necropsy, quarantine and euthanasia rooms; maintenance of

a light, temperature, sound and humidity controlled environment; and an experienced veterinarian to provide veterinary care to laboratory rodents. All animals kept in this facility and reagents generated therein are considered the sole property of CDFD.

Following the decision to establish a Laboratory Animal Facility within the premises of M/s Vimta Labs Ltd., CDFD recruited two personnel to set up and operate this facility. From July 1, 2011, CDFD started its activities at the Laboratory Animal Facility, beginning by establishing colonies of two transgenic mouse strains (Figure 1). Infrastructure was established to house mice in IVCs (Figure 2, 3), and conduct standard experimental procedures (Figure 4). All procedures, conducted on animals housed in this facility, are approved by the Institutional Animal Ethics Committee (IAEC) constituted by the Committee for the Purpose of Control and Supervision of Experiments on Animals (CPCSEA), Ministry of Environment and Forests, Govt. of India, at M/s Vimta Labs Ltd.

Currently, this facility houses approximately 150 mice of each transgenic strain, IP6K1 and Nnat. Procedures conducted on these animals include blood collection for measurement of biochemical parameters, embryo collection for the preparation of mouse embryonic fibroblasts, tail biopsies for genotyping analysis, and necropsy for histopathological analysis.

Future directions

In the near future, apart from further research being carried out on the two transgenic strains, we will obtain additional transgenic strains, and procure C57BL/6, BALB/c and FOXN1^{nu} mouse strains to expand our experimental activities. We aim to generate antibodies in mice against recombinant proteins being studied by several different investigators at CDFD. Tumourigenesis studies using Athymic Nude Mice and fungal pathogenesis studies using mice as model organisms are also planned.



Figure 1



Figure 2



Figure 3



Figure 4

Figure 1. Transgenic female mouse with new-born pups. **Figure 2.** Individually ventilated caging system with air handling unit, cage racks, and cages with identification tags. **Figure 3.** Laboratory animal facility staff working at a cage changing station to transfer mice to clean sterile cages. **Figure 4.** Small laboratory equipment used in a procedure room adjacent to the animal rooms.

BIOINFORMATICS

Scientist-in-Charge	HA Nagarajaram	Staff Scientist
Other Members	R Chandra Mohan Prashanthi Katta	Technical Officer I Technical Assistant (CoE)

Objectives

1. To maintain the CDFD website, provide web based services and e-mail services;
2. To maintain various servers, workstations, PCs, printers and other peripheral devices;
3. To maintain Institute-wide LAN as well as the internet connectivity;
4. To coordinate the procurement process of workstations, PCs, laptops, printers, other peripheral devices and software required;
5. To secure the CDFD network from security threats;
6. To integrate Institute's network into National and International grid computing networks.

Summary of work done until the beginning of this reporting year (April 1, 2010 - March 31, 2011)

- ❖ Activities related to installation, administration and maintenance of servers which provide various services, databases and computational jobs were undertaken.
- ❖ A comprehensive PC Annual Maintenance Contract and the agreement for remote monitoring and managed services for Sun servers in the Data Center set up were renewed.

- ❖ Successfully migrated CDFD Network to NKN.
- ❖ Signed a new MoU with CDAC for availing GARUDA-grid facility.

Details of progress made in the current reporting year (April 1, 2011 - March 31, 2012)

- ❖ Activities related to installation, administration and maintenance of servers which provide various services, databases and computational jobs were undertaken.
- ❖ Internet, web services were provided with enhanced functionalities.
- ❖ High-end PCs, workstations, laptops, scanners and printers were procured and installed.
- ❖ Existing PC Annual Maintenance Contract was renewed. Remote monitoring and managed services for Sun servers in the Data Center were also renewed.
- ❖ Procured a dedicated, high-end server with 3TB storage capacity for E-mail facility. Migrated existing email server to Zimbra Email server. The migration was done with minimum downtime.
- ❖ Upgraded 4Mbps leased line from BSNL to 8Mbps.
- ❖ Proposal from NIC-DBT for the deployment of IPv6 was initiated.

INSTRUMENTATION

Head	Raghavendrachar J	Staff Scientist
Other Members	R N Mishra	Technical Officer II
	S D Varalaxmi	Technical Officer I
	M Laxman	Technical Officer I
	R M K Sathyanarayana	Technical Officer I
	T Ramakrishna Reddy	Technical Assistant

Objective

To maintain, repair and service all the equipment in the Laboratory. To provide pre-installation requirements for new instruments and to coordinate with the manufacturers/ their agents in installation and warranty service of the new instruments. Also to provide reports on the newly arrived instruments and to follow up with suppliers for short shipped items.

Summary of work done until the beginning of the reporting year (April 1, 2010 - March 31, 2011)

We had set up the facilities for major instruments like ABI Solid 3.5 Next Generation whole Genome DNA Sequencer, Illumina Bead Express Whole Genome Genotyping System, Becton Dickinson FACS ARIA Flow Cytometer, Waters HPLC, Perkin Elmer Packard 2910 Liquid Scintillation Counter, Nikon Live Cell Imaging System, Nikon Stereomicroscope with Microinjection system and Conviron Plant Growth Chambers.

During the year 2010-11, we installed 138 new equipments and also completed 412 work orders for repair and maintenance of various laboratory equipments. We had successfully set up the video conferencing system to communicate and make presentations from CDFD to other institutions in India and abroad. In addition, we were involved in organizing the audio and visual requirements for presentations in various seminars, lectures and workshops, distinguished Scientist lectures etc. We were actively involved in conducting the 14th Transcription Assembly Meeting, Indo-Canada

Tuberculosis Workshop and Indo-French Bioinformatics Meeting.

Details of progress made in the current reporting year (April 1, 2011 - March 31, 2012)

During the year 2011-12, we have installed 144 new equipments like Beckman High Speed Centrifuge, Hitachi Spectrofluorimeter, Robotic Protein Crystallization System, Accuri C6 Flowcytometer, Two Color IR Imaging System, Individually Ventilated Cages for Animal house, Microscopes, PCR Machines, Nanodrop Spectrophotometers, Refrigerated Centrifuges, Orbital Shakers, Electroporators, -80°C Freezer, -20°C Freezers, cold cabinets etc., and have also completed 472 work orders for repair and maintenance of various laboratory equipments. We have successfully set up the ID card printing system for issuing identity cards instantly to all our staff, research scholars, and project staff.

In addition, we are conducting basic course on instrumentation and imparting theory as well as practical knowledge on the equipments. We were involved in organizing the audio and visual requirements for presentations in various seminars, lectures and workshops, Foundation Day lecture series, distinguished Scientist lectures held in CDFD. We were actively involved in conducting the Ramalingaswamy Fellows' Conclave and DBT Silver Jubilee Lectures. We maintained most of the equipment with maximum uptime in the Laboratory. Most of the instruments are maintained by our Instrumentation staff, thereby saving on the expensive AMCs and with very little downtime of the equipment.

प्रकाशन
Publications

RESEARCH PAPERS

A. Publications during the year 2011

1. Ali J, Paila U and Ranjan A (2011). ApicoAlign: An alignment and sequence search tool for apicomplexan proteins. **BMC Genomics** 12 (Suppl. 3): S6.
2. Anupama K, Leela JK and Gowrishankar J (2011). Two pathways for RNase E action in *Escherichia coli* *in vivo* and bypass of its essentiality in mutants defective for Rho-dependent transcription termination. **Molecular Microbiology** 82: 1330-1348.
3. Arora A, Chandra NR, Das A, Gopal B, Mande SC, Prakash B, Ramachandran R, Sankaranarayanan R, Sekar K, Suguna K, Tyagi AK and Vijayan M (2011). Structural biology of *Mycobacterium tuberculosis* proteins: The Indian efforts. **Tuberculosis** 91: 456-468.
4. Arunkumar KP and Nagaraju J (2011). Drosophila intersex orthologue in the silkworm, *Bombyx mori* and related species. **Genetica** 139: 141-147.
5. Bairwa G and Kaur R (2011). A novel role for a glycosylphosphatidylinositol-anchored aspartyl protease, CgYps1, in the regulation of pH homeostasis in *Candida glabrata*. **Molecular Microbiology** 79: 900-913.
6. Bentur JS, Sinha DK, Padmavathy C, Revathy C, Muthulakshmi M and Nagaraju J (2011). Isolation and characterization of microsatellite loci in the asian rice gall midge (*Orseolia oryzae*) (Diptera: Cecidomyiidae). **International Journal of Molecular Science** 12: 755-772.
7. Borah S, Shivarathri R and Kaur R (2011). The Rho1 GTPase-activating protein CgBem2 is required for survival of azole stress in *Candida glabrata*. **Journal of Biological Chemistry** 286: 34311-34324.
8. Bose S, Sakhuja P, Bezawada L, Agarwal AK, Kazim NS, Khan LA, Sarin SK and Ramakrishna G (2011). Hepatocellular carcinoma with persistent hepatitis B virus infection shows unusual downregulation of Ras expression and differential response to Ras mediated signaling. **Journal of Gastroenterology and Hepatology** 26: 135-144.
9. Chalissery J, Muteeb G, Nisha CK, Mohan S, Jisha V and Sen R (2011). Interaction surface of the transcription terminator Rho required to form a complex with the C-terminal domain of the antiterminator NusG. **Journal of Molecular Biology** 405: 49-64.
10. Chatterjee N, Kiran S, Ram BM, Islam N, Ramasarma T and Ramakrishna G (2011). Diperoxovanadate can substitute for H₂O₂ at much lower concentration in inducing features of premature cellular senescence in mouse fibroblasts (NIH3T3). **Mechanisms of Ageing and Development** 132: 230-239.
11. Das A and Mukhopadhyay S (2011). The evil axis of obesity, inflammation and type-2 diabetes. **Endocrine, Metabolic and Immune Disorders - Drug Targets** 11: 23-31.
12. Dutta UR, Rajitha P, Kumar PV and Dalal A (2011). Cytogenetic abnormalities in 1162 couples with recurrent miscarriages in southern region of India: Report and review. **Journal of Assisted Reproduction and Genetics** 28: 145-149.
13. Gunnarsdóttir ED, Nandineni MR, Li M, Myles S, Gil D, Pakendorf B and Stoneking M (2011). Larger mtDNA than Y-chromosome differences between matrilineal and patrilineal groups from Sumatra. **Nature Communications** 2: 228.
14. Hegde S, Klimova E, Mande S, Medvedeva IA, Makeev V and Permina EA (2011). Using the operonic gene pairs for establishing the threshold correlation coefficient of differently expressed genes. **Biofizika** 56: 1062-1064. [Article in Russian]
15. Jailkhani N, Ravichandran S, Hegde SR, Siddiqui Z, Mande SC and Rao KVS (2011). Delineation of key regulatory elements identifies points of vulnerability in the mitogen-activated signaling network. **Genome Research** 21: 2067-2081.
16. Kalyani BS, Muteeb G, Qayyum MZ and Sen R (2011). Interaction with the nascent RNA is a prerequisite for the recruitment of Rho to the transcription elongation complex *in vitro*. **Journal of Molecular Biology** 413: 548-560.

17. Khanna V, Jain M, Barthwal MK, Kalita D, Boruah JJ, Das SP, Islam NS, Ramasarma T and Dikshit M (2011). Vasomodulatory effect of novel peroxovanadate compounds on rat aorta: Role of Rho kinase and nitric oxide/cGMP pathway. **Pharmacology Research** 63: 274-282.
18. Kole L, Giri B, Manna SK, Pal B and Ghosh S (2011). Biochanin-A, an isoflavon, showed anti-proliferative and anti-inflammatory activities through the inhibition of iNOS expression, p38-MAPK and ATF-2 phosphorylation and blocking NF- κ B nuclear translocation. **European Journal of Pharmacology** 653: 8-15.
19. Kumar CMS and Mande SC (2011). Protein chaperones and non-protein substrates: On substrate promiscuity of GroEL. **Current Science** 100: 1646-1653.
20. Kumar P, Chaitanya PS and Nagarajaram HA (2011). PSSRdb: A relational database of polymorphic simple sequence repeats extracted from prokaryotic genomes. **Nucleic Acids Research** 39: D601-D605.
21. Kwei KA, Shain AH, Bair R, Montgomery K, Karikari CA, van de Rijn M, Hidalgo M, Maitra A, Bashyam MD and Pollack JR (2011). *SMURF1* amplification promotes invasiveness in pancreatic cancer. **PLoS One** 6: e23924.
22. Li YR, Zou HS, Che YZ, Cui YP, Guo W, Zou LF, Chatterjee S, Biddle EM, Yang CH and Chen GY (2011). A novel regulatory role of HrpD6 in regulating *hrp-hrc-hpa* genes in *Xanthomonas oryzae* pv. *oryzicola*. **Molecular Plant-Microbe Interactions** 24: 1086-1101.
23. Maddika S, Kavela S, Rani N, Palicharla VR, Pokorny JL, Sarkaria JN and Chen J (2011). WWP2 is an E3 ubiquitin ligase for PTEN. **Nature Cell Biology** 13: 728-733.
24. Mahali S, Raviprakash N, Raghavendra PB and Manna SK (2011). Advanced glycation end products (AGEs) induce apoptosis via a novel pathway: Involvement of Ca²⁺ mediated by interleukin-8 protein. **Journal of Biological Chemistry** 286: 34903-34913.
25. Majumdar S, Dutta K, Manna SK, Basu A and Bishayi B (2011). Possible protective role of chloramphenicol in TSST-1 and coagulase positive *Staphylococcus aureus* induced septic arthritis with altered levels of inflammatory mediators. **Inflammation** 34: 268-281.
26. Manna SK, Gangadharan C, Edupalli D, Raviprakash N, Navneetha T, Mahali S and Thoh M (2011). Ras puts brake on doxorubicin-mediated cell death in p53 expressing cells. **Journal of Biological Chemistry** 286: 7339-7347.
27. Marbaniang CN and Gowrishankar J (2011). Role of ArgP (IciA) in lysine-mediated repression in *Escherichia coli*. **Journal of Bacteriology** 193: 5985-5996.
28. Mohammad TA and Nagarajaram HA (2011). A hierarchical approach to protein fold prediction. **Journal of Integrative Bioinformatics** 8: 185.
29. Mohareer K, Sahdev S and Hasnain SE (2011). Baculovirus *p35* gene is oppositely regulated by P53 and AP-1 like factors in *Spodoptera frugiperda*. **Biochemical and Biophysical Research Communications** 414: 688-693.
30. Mrinal N, Tomar A and Nagaraju J (2011). Role of sequence encoded κ B DNA geometry in gene regulation by Dorsal. **Nucleic Acids Research** 39: 9574-9591.
31. Mukhopadhyay S and Balaji KN (2011). The PE and PPE proteins of *Mycobacterium tuberculosis*. **Tuberculosis** 91: 441-447.
32. Naik US, Gangadharan C, Abbagani K, Nagalla B, Dasari N and Manna SK (2011). A study of nuclear transcription factor-kappa B in childhood autism. **PLoS One** 6: e19488.
33. Nair S, Pandey AD and Mukhopadhyay S (2011). The PPE18 protein of *Mycobacterium tuberculosis* inhibits NF- κ B/rel-mediated proinflammatory cytokine production by upregulating and phosphorylating SOCS3 protein. **Journal of Immunology** 186: 5413-5424.
34. Ponnala R and Dalal A (2011). Partial monosomy 7q. **Indian Pediatrics** 48: 399-401.
35. Reich D, Patterson N, Kircher M, Delfin F, Nandineni MR, Pugach I, Ko AMS, Ko YC, Jinam TA, Phipps ME, Saitou N,

- Wollstein A, Kayser M, Paabo S and Stoneking M (2011). Denisova admixture and the first modern human dispersals into Southeast Asia and Oceania. **American Journal of Human Genetics** 89: 516-528.
36. Sahai I, Zytkowick T, Kotthuri SR, Kotthuri AL, Eaton RB and Akella RRD (2011). Neonatal screening for inborn errors of metabolism using tandem mass spectrometry: Experience of the pilot study in Andhra Pradesh, India. **Indian Journal of Pediatrics** 78: 953-960.
37. Saxena S and Gowrishankar J (2011). Modulation of Rho-dependent transcription termination in *Escherichia coli* by the H-NS family of proteins. **Journal of Bacteriology** 193: 3832-3841.
38. Saxena S and Gowrishankar J (2011). Compromised factor-dependent transcription termination in a nusA mutant of *Escherichia coli*: Spectrum of termination efficiencies generated by perturbations of Rho, NusG, NusA, and H-NS family proteins. **Journal of Bacteriology** 193: 3842-3850.
39. Shamim MT and Nagarajaram HA (2011). SVM-based method for protein structural class prediction using secondary structural content and structural information of amino acids. **Journal of Bioinformatics and Computational Biology** 9: 489-502.
40. Sharadamma N, Khan K, Kumar S, Patil N, Hasnain SE and Muniyappa K (2011). Synergy between the N-terminal and C-terminal domains of *Mycobacterium tuberculosis* HupB is essential for high-affinity binding, DNA supercoiling and inhibition of RecA-promoted strand exchange. **FEBS Journal** 278: 3447-3462.
41. Shukla JN, Jadhav S and Nagaraju J (2011). Novel female-specific splice form of *dsx* in the silkworm, *Bombyx mori*. **Genetica** 139: 23-31.
42. Singh NP, Madabhusi SR, Srivastava S, Senthilkumar R, Neeraja C, Khosla S and Mishra RK (2011). Epigenetic profile of the euchromatic region of human Y chromosome. **Nucleic Acids Research** 39: 3594-3606.
43. Swapna G, Chakraborty A, Kumari V, Sen R and Nagaraja V (2011). Mutations in β' subunit of *E. coli* RNA polymerase perturb the activator polymerase functional interaction required for promoter clearance. **Molecular Microbiology** 80: 1169-1185.
44. Terenius O, ... (67 authors) ..., Nagaraju J, Richard H, Herrero S, Gordon K, Swevers L and Smagge G (2011). RNA interference in Lepidoptera: An overview of successful and unsuccessful studies and implications for experimental design. **Journal of Insect Physiology** 57: 231-245.
45. Thiagarajan D, Dev RR and Khosla S (2011). The DNA methyltransferase Dnmt2 participates in RNA processing during cellular stress. **Epigenetics** 6: 103-113.
46. Thoh M, Babajan B, Raghavendra PB, Sureshkumar C and Manna SK (2011). Azadirachtin interacts with retinoic acid receptors and inhibits retinoic acid-mediated biological responses. **Journal of Biological Chemistry** 286: 4690-4702.
47. Yadav AK, Desai PR, Rai MN, Kaur R, Ganesan K and Bachhawat AK (2011). Glutathione biosynthesis in the yeast pathogens *Candida glabrata* and *Candida albicans*: Essential in *C. glabrata*, and essential for virulence in *C. albicans*. **Microbiology** 157: 484-495.
- B. Publications in 2012 (Till March 31, 2012)**
48. Acharya V and Nagarajaram HA (2012). Hansa: An automated method for discriminating disease and neutral human nsSNPs. **Human Mutation** 33: 332-327.
49. Akhter Y, Ehebauer MT, Mukhopadhyay S and Hasnain SE (2012). The *PE/PPE* multigene family codes for virulence factors and is a possible source of mycobacterial antigenic variation: Perhaps more? **Biochimie** 94: 110-116.
50. Bashyam MD, Purushotham G, Chaudhary AK, Rao KM, Acharya V, Mohammad TA, Nagarajaram HA, Hariram V and Narasimhan C (2012). A low prevalence of MYH7/MYBPC3 mutations among familial hypertrophic cardiomyopathy patients in India. **Molecular and Cellular Biochemistry** 360: 373-382.
51. Dutta UR, Pidugu VK, Goud V and Dalal AB (2012). Mosaic Down syndrome with a marker: Molecular cytogenetic

- characterization of the marker chromosome. *Gene* 495:199-204.
52. Hegde SR, Rajasingh H, Das C, Mande SS and Mande SC (2012). Understanding communication signals during Mycobacterial latency through predicted genome-wide protein interactions and boolean modeling. *PLoS One* 7: e33893.
 53. Kumar R, Panigrahi I, Dalal A and Agarwal S (2012). Sick cell anemia - Molecular diagnosis and prenatal counseling: SGPGI experience. *Indian Journal of Pediatrics* 79: 68-74.
 54. Mukhopadhyay S, Nair S and Ghosh S (2012). Pathogenesis in tuberculosis: Transcriptomic approaches to unraveling virulence mechanisms and finding new drug targets. *FEMS Microbiology Reviews* 36: 463-485.
 55. Pidugu VK, Pothula RKS, Narra D and Srivastava V (2012). Development of a multiplex Polymerase Chain Reaction method for specific detection of genetically modified cotton events MON 531 and MON 15985. *International Journal of Basic and Applied Sciences* 1: 45-53.
 56. Shain AH, Giacomini CP, Matsukuma K, Karikari CA, Bashyam MD, Hidalgo M, Maitra A and Pollack JR (2012). Convergent structural alterations define SWItch/Sucrose NonFermantable (SWI/SNF) chromatin remodeler as a central tumor suppressive complex in pancreatic cancer. *Proceedings of the National Academy of Sciences of the USA* 109: E252-E259.
 57. Siddiq EA, Vemireddy LR and Nagaraju J (2012). Basmati rices: Genetics, breeding and trade. *Agricultural Research* 1: 25-36.
- C. Publications in Press (as on March 31, 2012)**
58. Almeida RPP, Killiny N, Newman KL, Chatterjee S, Ionescu M and Lindow SE. Contribution of *rpfB* to cell-to-cell signal synthesis, virulence, and vector transmission of *Xylella fastidiosa*. *Molecular Plant-Microbe Interactions*.
 59. Angalena R, Aggarwal S, Phadke SR and Dalal A. Compound heterozygote condition in beta thalassemia major due to a novel single nucleotide deletion (-T) at codon 69 in association with IVS 1-5 (G>C) mutation. *International Journal of Laboratory Hematology*.
 60. Bashyam MD, Chaudhary AK and Bhat V. The IVS2+837T>G appears to be a relatively common 'rare' β -GLOBIN gene mutation among β -Thalassemia patients in the South Indian state of Karnataka. *Hemoglobin*.
 61. Bashyam MD, Chaudhary AK, Reddy EC, Reddy V, Acharya V, Nagarajaram HA, Devi ARR, Bashyam L, Dalal AB, Gupta N, Kabra M, Agarwal M, Phadke SR, Tainwala R, Kumar R and Hariharan SV. A founder ectodysplasin A receptor (*EDAR*) mutation results in a high frequency of the autosomal recessive form of hypohidrotic ectodermal dysplasia in India. *British Journal of Dermatology*.
 62. Bhat KH, Chaitanya CK, Parveen N, Varman R, Ghosh S and Mukhopadhyay S. Proline-Proline-Glutamic Acid (PPE) protein Rv1168c of *Mycobacterium tuberculosis* augments transcription from HIV-1 Long Terminal Repeat promoter. *Journal of Biological Chemistry*.
 63. Fialho AM, Salunkhe P, Manna SK, Mahali S and Chakrabarty AM. Glioblastoma multiforme: Novel therapeutic approaches. *ISRN Neurology*.
 64. Kumar P and Nagarajaram HA. A study on mutational dynamics of simple sequence repeats in relation to mismatch repair system in prokaryotic genomes. *Journal of Molecular Evolution*.
 65. Manna SK. Double-edged sword effect of biochanin to inhibit nuclear factor kappaB: Suppression of serine/threonine and tyrosine kinases. *Biochemical Pharmacology*.
 66. Muranjan M, Agarwal S, Lahiri K and Bashyam M. Novel biochemical abnormalities and genotype in Farber disease. *Indian Pediatrics*.
 67. Padma Priya T and Dalal AB. Tuberos scleriosis: Diagnosis and prenatal diagnosis by MLPA. *Indian Journal of Pediatrics*.
 68. Patil SJ, Ponnala R, Shah S and Dalal A. Mosaic Trisomy 9 presenting with congenital heart disease, facial dysmorphism and pigmentary skin lesions: Intricate issues of genetic counseling. *Indian Journal of Pediatrics*.

69. Ponnala R, Ranganath P, Dutta UR, Pidugu VK and Dalal AB. Phenotypic and molecular characterization of partial trisomy 2q resulting from insertion-duplication in chromosome 18q: A case report and review of literature. **Cytogenetic and Genome Research**.
70. Pradhan BB, Ranjan M and Chatterjee S. XadM, a novel adhesin of *Xanthomonas oryzae* pv. *oryzae*, exhibits similarity to Rhs family proteins and is required for optimum attachment, biofilm formation and virulence. **Molecular Plant-Microbe Interactions**.
71. Rai R, Ranjan M, Pradhan BB and Chatterjee S. Atypical regulation of virulence associated functions by a Diffusible Signal Factor in *Xanthomonas oryzae* pv. *oryzae*. **Molecular Plant-Microbe Interactions**.
72. Ramasarma T, Joshi NV, Sekar K, Uthayakumar M and Sherlin D. Transmembrane domains. **eLS (formerly known as Encyclopedia of Life Sciences)**.
73. Ramasarma T. A touch of history and a peep into the future of the lipid-quinone known as coenzyme Q and ubiquinone. **Current Science**.
74. Ramasarma T. In praise of H₂O₂, the versatile ROS, and its vanadium complexes. **Toxicology Mechanisms and Methods**.
75. Ranganath P, Sharma V, Danda S, Nandineni MR and Dalal A. Report of novel mutations in the lysosomal sialidase (NEU1) gene in Indian cases of sialidosis. **Indian Journal of Medical Research**.
76. Shashni R, Mishra S, Kalayani BS and Sen R. Suppression of *in vivo* Rho-dependent transcription termination defects: Evidence for kinetically controlled steps. **Microbiology**.
77. Singh CP, Singh J and Nagaraju J. A baculovirus-encoded miRNA suppresses its host miRNAs biogenesis by regulating the Exportin-5 co-factor Ran. **Journal of Virology**.
78. Verma PK, Dalal A, Mittal B and Phadke SR. Utility of MLPA in mutation analysis and carrier detection for Duchenne muscular dystrophy. **Indian Journal of Human Genetics**.
79. Verma PK, Ranganath P, Dalal A and Phadke SR. Spectrum of lysosomal storage disorders at medical genetics center in North India. **Indian Pediatrics**.
- D. Other Publications**
1. Dalal A (2011). Annual review of genomics and human genetics, 2010. (Book Review) **Current Science** 100: 933-934.
 2. Dalal A (2011). Genetic tests. **API Textbook of Medicine**, 9th Edition, Pg. 21-25. Editor-in-Chief: Munjal YP. Jaypee Brothers Medical Publications.
 3. Gowrishankar J (2011). Funding of investigator-initiated research projects in India: The case for moving from a proposal-based to a performance-based evaluation process. **Current Science** 101: 823.
 4. Gowrishankar J (2011). Why scientists are missing (Letter). **Down to Earth** (1 May 2011), Pg. 6.
 5. Ranganath P and Dalal A (2012). Annual review of genomics and human genetics, 2011. (Book Review) **Current Science** 102: 923-924.
 6. Gokul G and Khosla S. DNA methylation and cancer. **Epigenetics: Development and Disease**. Editor: Kundu TK. Springer Publications (In press).
 7. Gowrishankar J. What should our policy be for appointing non-Indian citizens as heads of public institutions? **Current Science** (In press).
- E. Patents**
- (i) **Granted**
Gowrishankar J and Nandineni MR. A microbial process for arginine production.
❖ Japanese Patent 4836440, issued on 7 October 2011.
 - (ii) **Applications filed**
Nagaraju J. Virus resistant transgenic silkworm.
❖ PCT International Application No. PCT/IN2012/000083 filed on 2 February 2012.

मानव संसाधन विकास
Human Resource Development

PhD Program

For the PhD program CDFD invites applications from highly motivated candidates willing to take up challenges in modern biology, usually in the month of March. Keeping in view the interdisciplinary nature of modern biology, the Centre especially encourages persons from different scientific disciplines to take up challenges in these areas. Those admitted as Junior Research Fellows (JRFs) are encouraged to take admission in the PhD program of Manipal Academy of Higher Education or University of Hyderabad.

The eligibility for the program is MBBS or Masters degree in any branch of Science, Technology or Agriculture from a recognized University or Institute. Candidates (other than MBBS graduates) must have cleared National Eligibility Test (NET) with valid CSIR-JRF or UGC-JRF or DBT-JRF or ICMR-JRF or ICAR-JRF or INSPIRE-Ph.D. or DAE-JEST or GATE (All India top 100 ranks of all the streams). Those who have appeared for their final semester examination, but are awaiting results, are also eligible to apply. Those with independent Senior Research Fellowships (SRF) from CSIR can also apply. As the number of applicants outnumbers the seats available each year by a ratio of 1:40 or more, eligible candidates are invited for a written examination followed by interviews of short-listed candidates.

Currently the Centre has 87 Research Scholars working for their doctorates in different areas of

research. In the reporting year 6 of the Research Scholars have completed PhD and are pursuing careers in science elsewhere in India or abroad.

Postdoctoral Program

In addition to the JRF program, the Centre also carries out training at the post-doctoral level. The post-doctoral fellows are funded through the extramural grants that CDFD receives. Some post-doctoral fellows are also selected competitively by the DST fast track young scientist scheme, or the DBT post-doctoral fellowship program.

Summer Training Program

CDFD provides admissions to summer training program only to those students who are supported either by the Indian Academy of Science, Bangalore or Jawaharlal Nehru Centre for Advanced Scientific Research, Bangalore or the Kishore Vigyanik Protsahan Yojna, New Delhi. In the reporting year 24 students received summer training at the Centre.

Training for students from BITS, Pilani

CDFD has an agreement with BITS, Pilani to provide project training to their M.Sc. students. Under this programme, the students spend 6 months to 1 year at CDFD and work on active projects being carried out here. The project work helps the students in gaining hands-on experience in modern biology. In the reporting year, 7 students were given the opportunity to avail training under this programme.

Research Scholars Conferred Ph.D Degree During the Reporting Period

Scholar	Supervisor	Date of viva voce examination	Title of thesis
Maikho Thoh	Sunil K Manna	06.06.2011	Understanding the mechanism of Azadirachtin-mediated cell signalling: Role in anti-inflammation and anti-tumorigenesis
Pramod Kumar	Shekhar C Mande	13.07.2011	Structural and functional study of the toxin-antitoxin modules in <i>Mycobacterium tuberculosis</i>
Jyoti Singh	J Nagaraju	18.07.2011	Identification and characterization of miRNAs and their targets for studying gene regulation and insect-pathogen interaction in the domesticated silkworm, <i>Bombyx mori</i>
Vishal Acharya	H A Nagarajaram	25.11.2011	Computational studies of disease-causing mutations in proteins
Arvind Singh	Gayatri Ramakrishna	29.11.2011	Studies on the functions of RAS in lung epithelium
Shivalika Saxena	J Gowrishankar	23.02.2012	Studies on transcription-translation coupling and the consequences of its failure in <i>Escherichia coli</i> : Modulation of Rho-dependent transcription termination by H-NS family of proteins

व्याख्यान, बैठक, कार्यशाला व
अन्य महत्वपूर्ण कार्यक्रम
**Lectures, Meetings, Workshops
and Important Events**

DISTINGUISHED VISITORS AND LECTURES

Visitor	Title of Lecture	Date
Dr Krishna Murari Sinha, Institute of Molecular Medicine, New Delhi	Multiple pathways of DNA double-strand break repair in mycobacterium	01.04.2011
Dr Aswin Seshasayee, National Centre for Biological Sciences, Bangalore	Functional and comparative genomics of bacterial signaling and genome optimizations	20.04.2011
Dr Srinivasa M Srinivasula, National Cancer Institute, NIH, USA	Autophagy in host defense: Role of p62 in TLR signaling	21.04.2011
Dr Sourav Banerjee, University of California, USA	Micromanaging neuronal network: Regulatory control of neuronal development and plasticity by microRNAs and piRNAs	26.04.2011
Dr Ravikumar Ponnusamy, University of California, USA	Training and taming fear memories in the mammalian brain: Neural pathways of fear development and reduction	06.06.2011
Dr Shweta Suresh, National Centre for Biological Sciences, Bangalore	IndiaBioscience (IBS)-An initiative to strengthen life-sciences research in India	24.06.2011
Dr Raghavendra Nidhanapati, Ohio State University, USA	EDGF/p75 and novel host proteins interacting with HIV-1 preintegration complex	29.06.2011
Dr Milan Surjit, Institute of Genetics and Molecular and Cellular Biology, France	How do we respond to stress? A new insight into the mechanism of action of a stress hormone	01.07.2011
Dr Nagaraj Balasubramanian, Indian Institute of Science Education and Research, Pune	Adhesion dependent regulation of membrane trafficking. Role in anchorage dependence and cancer.	14.07.2011
Dr Beena Krishnan, University of Massachusetts Amherst, USA	Unraveling the mechanisms of folding and function of serpins: <i>In vitro</i> and <i>in vivo</i> .	27.07.2011
Dr Jitendra K Gautam, University of Virginia Health System, USA	Toll signalling, inflammation and kidney autoimmunity: Associated?	14.10.2011
Dr Radha Devi Chauhan, The Rockefeller University, USA	Insight into structure and versatility of the transport channel of the nuclear pore complex	14.10.2011
Prof Richard D Vaughan-Jones, University of Oxford, UK	H ⁺ ion signalling in heart and cancer	19.10.2011
Dr K Natrajan, Jawaharlal Nehru University, New Delhi	Novel regulatory paradigms in fungal pathogenesis: Complexes that regulate transcription	24.10.2011
Dr Anirban Banerjee, The Rockefeller University, USA	Structural and mechanistic studies of voltage-gated potassium channels and their interactions with peptide toxins	07.11.2011
Dr Randall Peterson, Harvard Medical School, USA	Discovering small molecules through <i>in vivo</i> screening in Zebrafish	09.11.2011
Dr Benu Brata Das, National Cancer Institute, NIH, USA	A novel nuclear and mitochondrial DNA repair enzyme Tyrosyl-DNA phosphodiesterase (TDP1): Insights into Topoisomerase 1-induced DNA damage and human disease	18.11.2011

Visitor	Title of Lecture	Date
Dr Upender Manne, University of Alabama at Birmingham, USA	Preclinical validation of molecular markers of colorectal cancer	08.12.2011
Prof Mark Stoneking, Max Planck Institute for Evolutionary Anthropology, Germany	Admixture signals in modern human populations from archaic genomes	13.12.2011
Prof Jagan Pongubala, University of Hyderabad, Hyderabad	Gene regulatory networks and chromatin dynamics controlling hematopoietic lineage differentiation	15.12.2011
Prof Rajagopal Ramesh, The University of Oklahoma Health Sciences Center, USA	Interleukin (IL)-24-based cancer therapy: Rationale for testing in the clinic	19.12.2011
Dr Tirumala Kumar Chowdary, Tufts University School of Medicine, USA	Passing the baton – Structure reveals regulatory role of gH/gL complex in herpesvirus entry	09.01.2012
Dr Barnali Neel Chaudhuri, University of California, USA	Organization of the mycobacterial partition assembly	11.01.2012
Dr Dharendra K Simanshu, Memorial Sloan-Kettering Cancer Center, USA	Molecular machineries involved in trafficking of signaling lipids and small RNA-mediated gene silencing	13.01.2012
Dr Rajakumara Eerappa, Memorial Sloan-Kettering Cancer Center, USA	Structural and biochemical basis for methylated DNA and histone codes read-out and interpretation by chromatin associated modular proteins	20.01.2012
Dr Dhruv K Sethi, Harvard Medical School, USA	Horror autotoxicus: T cell receptor recognition of self and foreign antigens	23.01.2012
Prof Sue Lin-Chao, Institute of Molecular Biology, Academia Sinica, Taiwan	The role of membrane binding in RNase E mediated RNA decay	24.01.2012
Prof Lothar H Wieler, Freie University, Germany	The EHEC enigma – Genes on the move	24.01.2012
Dr Purusharth Rajyaguru, University of Arizona, USA	To translate, remain silent or get destroyed: How are mRNA fate decisions made?	27.01.2012
Prof Martin Killias, University of Zurich Switzerland	Experimental research in criminology and criminal justice	02.02.2012
Prof Junjie Chen, The University of Texas MD Anderson Cancer Center, USA	DNA damage signaling and DNA repair	06.02.2012
Prof Toru Shimada, The University of Tokyo, Japan	Genetic and genomic studies on the food habits of the silkworm	24.02.2012
Prof Aseem Ansari, University of Wisconsin- Madison, USA	Chemical-genomic dissection of the CTD code of RNA polymerase II	05.03.2012
Prof Prabhat Arya, Institute of Life Sciences, Hyderabad	Going in for protein:protein interactions	29.03.2012

IMPORTANT EVENTS

Event	Partnering Institutions	Date
MoU between CDFD and Survey of India (Sol)	CDFD-Sol	12.04.2011
Handing over of campus and land between CDFD and Sol	CDFD-Sol	19.06.2011
Fire drill		21.06.2011 & 22.06.2011
CDFD Research Area Panels-Scientific Advisory Committee (RAP– SAC) Meeting		29.07.2011 & 30.07.2011
Independence Day celebrations		15.08.2011
MoU between CDFD, Govt. of Orissa and Institute of Life Sciences (ILS), Bhubaneswar		18.08.2011
Commemoration of Hindi week		09.09.2011 to 14.09.2011
CDFD Building Committee Meeting		13.10.2011
CDFD Finance Committee Meeting		13.10.2011
CDFD Governing Council Meeting		17.10.2011
Visit of delegation from Academia Sinica, Taiwan		01.11.2011
CDFD Society Meeting		22.11.2011
Dr Salam Khan Memorial Lecture	CDFD & University of Hyderabad	24.01.2012
Republic Day celebrations		26.01.2012
Commemoration of DBT Silver Jubilee		February 2012
CDFD Foundation Day celebrations		11.02.2012
Ramalingaswami Fellows' Conclave	DBT & CDFD	11.03.2012 to 14.03.2012
Hindi awareness workshop		16.03.2012

सी डी एफ डी कर्मचारियों की
विदेशों में प्रतिनियुक्ति
**Deputations Abroad of
CDFD Personnel**

DEPUTATIONS ABROAD - FACULTY & STAFF

Faculty	Period	Country of Visit and Purpose
J Gowrishankar	10.05.2011 to 25.05.2011 01.08.2011 to 10.08.2011	France: Scientific Council and Industrial Research Committee meeting of the Indo-French Council for Promotion of Advanced Research (IFCPAR) and visit to various laboratories. USA: Meeting on “Molecular Genetics of Bacteria and Phages” at University of Wisconsin, Madison and visit to various laboratories.
J Nagaraju	07.05.2011 to 15.05.2011 06.06.2011 to 20.06.2011 01.10.2011 to 06.10.2011 07.10.2011 to 10.10.2011 20.10.2011 to 25.10.2011 31.01.2012 to 12.02.2012	China: 2 nd Technical Meeting on “Development and Evaluation of Improved Strains of Insect Pests for SIT” at Nanjing and visit to various laboratories. USA: 5 th “Annual Arthropod Genomics Symposium” at Kansas City and visit to various laboratories. The Netherlands: 6 th “International Symposium on Molecular Insect Science” followed by “Workshop on Sex Determination” at Amsterdam. USA: Young Investigator Meeting (YIM) at Boston. China: Plenary talk in the “International Symposium on Silkworm Functional Genomics and Modern Silk Road” at Chongqing. Japan: Visit to the University of Tokyo, Tokyo; National Institute of Agrobiological Sciences, Tsukuba; and, National Institute of Genetics, Mishima under the Indo-Japan Cooperative Science Programme (IJCSP).
Shekhar C Mande	16.05.2011 to 20.05.2011 02.07.2011 to 13.07.2011 21.07.2011 to 24.07.2011	United Kingdom: Seminar on “Trends in protein biophysics: From in silico molecules to <i>in vivo</i> and <i>in vitro</i> proteins” at the University of Warwick, Coventry. Italy & Spain: Gordon Conference on Tuberculosis Drug Development at Lucca and visit to various laboratories. Russia: Indo-Russian Satellite MCCMB meeting on Computational Biology at Moscow.
Ranjan Sen	18.06.2011 to 26.06.2011	USA: FASEB summer conference on “Mechanisms and Regulation of Prokaryotic Transcription” at Vermont.
Akash Ranjan	21.07.2011 to 24.07.2011 29.11.2011 to 03.12.2011	Russia: Indo-Russian Satellite MCCMB meeting on Computational Biology at Moscow. Malaysia: InCoB/ISCB-Asia Joint Conference-2011 at Kuala Lumpur.

Faculty	Period	Country of Visit and Purpose
M D Bashyam	23.03.2011 to 09.04.2011	USA: 102 nd Annual Meeting of the American Association for Cancer Research (AACR) in Orlando and visit to various laboratories.
Rupinder Kaur	27.03.2012 to 04.04.2012	USA: ASM Conference on Candida and Candidiasis at San Francisco.
Ashwin B Dalal	10.10.2011 to 15.10.2011	Canada: Workshop on "Genetics in Developing Countries" organized by International Genetics Education Network (IGEN) at Montreal.
Rashna Bhandari	04.11.2011 to 12.11.2011	USA: HHMI International Early Career Scientist 12.11.2011 Competition Symposium at Virginia and visit to various laboratories.
N Madhusudan Reddy	18.07.2011 to 28.08.2011	Germany: Conduct research in Prof. Mark Stoneking's laboratory in Leipzig.
Subhadeep Chatterjee	22.05.2011 to 27.05.2011	Italy: To attend course work on quorum sensing in Dr. Vittorio Venturi's laboratory at Trieste.
R Harinarayanan	10.08.2011 to 29.09.2011	USA: Conduct research in the Laboratory of Molecular Genetics at the National Institute of Child Health and Human Development, NIH, Bethesda.
Payel Ghosh	21.07.2011 to 24.07.2011	Russia: Indo-Russian Satellite MCCMB meeting on Computational Biology at Moscow.

DEPUTATIONS ABROAD - STUDENTS

Faculty	Period	Country of Visit and Purpose
Shubhada R Hegde	26.06.2011 to 01.07.2011 and 02.07.2011 to 08.07.2011	Germany: 61 st Meeting of Nobel Laureates and students at Lindau followed by visit to various research institutes in Germany.
Carmelita N Marbaniang and Amitabh Ranjan	02.08.2011 to 07.08.2011	USA: Conference on "Molecular Genetics of Bacteria and Phages".
S Divya Tej	21.09.2011 to 23.09.2011	Spain: Conference on "Genomic Imprinting and Beyond".
Sidhartha Kumar Mahali	29.01.2012 to 03.02.2012	USA: Conference on "Pathogenesis of Diabetes: Emerging Insights into Molecular Mechanisms".
Shashi Kiran	12.02.2012 to 16.02.2012	USA: Conference on "Sirtuins in Metabolism, Aging and Disease".
Babul Moni Ram	19.03.2012 to 24.03.2012	Canada: Conference on "Cell Death Pathways: Beyond Apoptosis".

सी डी एफ डी के
वरिष्ठ वैज्ञानिक व अधिकारी
**Senior Staff and
Officers of CDFD**

SCIENTIFIC GROUP LEADERS (FACULTY)

Dr. J Gowrishankar
Dr. J Nagaraju
Dr. Shekhar C Mande (till August 2011)
Dr. Ranjan Sen
Dr. Sunil Kumar Manna
Dr. Sangita Mukhopadhyay
Dr. M D Bashyam
Dr. H A Nagarajaram
Dr. Akash Ranjan
Dr. Sanjeev Khosla
Dr. Gayatri Ramakrishna
Dr. Rupinder Kaur
Dr. Ashwin Bhikaji Dalal
Dr. Rashna Bhandari
Dr. Madhusudan R Nandineni
Dr. Subhadeep Chatterjee
Dr. Abhijit A Sardesai
Dr. R Harinarayanan
Dr. Shweta Tyagi
Dr. Rohit Joshi
Dr. M V Subba Reddy
Dr. Arun Kumar K P

ADJUNCT FACULTY

Prof. E A Siddiq
Prof. T Ramasarma
Prof. Anuradha Lohia
Dr. Renu Wadhwa
Dr. Prajnya Ranganath

OTHER GROUP LEADERS

Mr. Raghavendrachar J
Ms. M Kavita Rao
Dr. Ankkur Goel

SENIOR ADMINISTRATIVE STAFF

Mr. K Ananda Rao (till July 2011)
Mr. J Sanjeev Rao
Mr. B Jagannathacharyulu

केन्द्र की समितियाँ

(31.03.2012 तक)

Committees of the Centre

(As on 31.03.2012)

MEMBERS OF CDFD SOCIETY

Shri Pawan K Bansal Hon'ble Minister for S&T and Earth Sciences	-	President (till July 2012)
Shri Vilasrao Deshmukh Hon'ble Minister for S&T and Earth Sciences	-	President (from July 2012)
Prof M K Bhan Secretary, DBT, New Delhi	-	Member
Prof Samir K Brahmachari Director General, CSIR, New Delhi	-	Member (Ex-officio)
Prof P Balaram Director, IISc, Bangalore	-	Member (Ex-officio)
Prof V S Chauhan Director, ICGEB, New Delhi	-	Member
Prof Dipankar Chatterji IISc, Bangalore	-	Member
Shri Satish Chandra Joint Secretary & Legal Adviser Ministry of Law, New Delhi	-	Member (Ex-officio)
Shri S Suresh Kumar Joint Secretary (PM) Ministry of Home Affairs, New Delhi	-	Member (Ex-officio)
Shri Sanjay Goel Director (Finance) DBT, New Delhi (Nominee of JS & FA, DBT)	-	Member (Ex-officio)
Shri M K Chhabra Director (Modernization) BPR&D, New Delhi (Nominee of DG, BPR&D)	-	Member (Ex-officio)
Dr Suman Govil Advisor, HRD Division, DBT, New Delhi	-	Member (Ex-officio)
Dr J Gowrishankar Director, CDFD	-	Member Secretary

MEMBERS OF CDFD GOVERNING COUNCIL

Prof M K Bhan Secretary, DBT, New Delhi	-	Chairperson
Prof Samir K Brahmachari Director General, CSIR, New Delhi	-	Member (Ex-officio)
Prof P Balaram Director, IISc, Bangalore	-	Member (Ex-officio)
Prof V S Chauhan Director, ICGEB, New Delhi	-	Member
Prof Dipankar Chatterji IISc, Bangalore	-	Member
Shri Satish Chandra Joint Secretary & Legal Adviser Ministry of Law, New Delhi	-	Member (Ex-officio)
Shri S Suresh Kumar Joint Secretary (PM) Ministry of Home Affairs, New Delhi	-	Member (Ex-officio)
Joint Secretary & Financial Advisor DBT, New Delhi	-	Member (Ex-officio)
Shri K N Sharma Additional Director General BPR&D, New Delhi (Nominee of DG, BPR&D)	-	Member (Ex-officio)
Dr Suman Govil Advisor, HRD Division, DBT, New Delhi	-	Member (Ex-officio)
Dr J Gowrishankar Director, CDFD, Hyderabad	-	Member Secretary

MEMBERS OF CDFD RESEARCH AREA PANELS – SCIENTIFIC ADVISORY COMMITTEE (RAP-SAC)

Prof P Balaram Director, IISc, Bangalore	-	Chairman
Prof Ramakrishna Ramaswamy Vice Chancellor, UoH, Hyderabad	-	Member
Dr Veena K Parnaik CCMB, Hyderabad	-	Member
Dr S K Apte Associate Director, BARC, Mumbai	-	Member
Dr D P Kasbekar CCMB, Hyderabad (Nominee of CCMB)	-	Member
Prof Sandhya S Visweswaraiah IISc, Bangalore	-	Member
Prof Usha Vijayraghavan IISc, Bangalore	-	Member
Prof Umesh Varshney IISc, Bangalore	-	Member
Prof Sanjeev Galande IISER, Pune	-	Member
Dr Chetan E Chitnis ICGEB, New Delhi	-	Member
Prof Jaya Sivaswami Tyagi AIIMS, New Delhi	-	Member
Prof Joyoti Basu Bose Institute, Kolkata	-	Member
Dr Debasisa Mohanty NII, New Delhi	-	Member
Dr M K Mathew NCBS, Bangalore	-	Member
Prof Shubha R Phadke SGPGI, Lucknow	-	Member

Dr Suman Govil Adviser, HRD Division, DBT, New Delhi (Nominee of DBT)	-	Member
Dr K V Bhat NBPGR, New Delhi (Nominee of Director General, ICAR)	-	Member
Dr Vijay Kumar ICMR, New Delhi (Nominee of Director General, ICMR)	-	Member
Nominee from Ministry of Home Affairs	-	Member
Dr J Gowrishankar Director, CDFD, Hyderabad	-	Member Secretary

MEMBERS OF CDFD ACADEMIC COMMITTEE

Prof A S Raghavendra Dean, School of Life Sciences University of Hyderabad, Hyderabad	-	Chair
Prof Anil K Tyagi University of Delhi, South Campus, New Delhi	-	Member
Dr K Satyamoorthy Director, Manipal Life Sciences Centre Manipal University, Manipal	-	Member
Dr D P Kasbekar CCMB, Hyderabad	-	Member
Dr Ranjan Sen CDFD, Hyderabad	-	Member
Dr Sanjeev Khosla Co-ordinator (Academics), CDFD, Hyderabad	-	Member Convenor

MEMBERS OF CDFD FINANCE COMMITTEE

Dr V S Chauhan Director, ICGEB, New Delhi	-	Chairman
Mr Sanjay Goel Director (Finance), DBT, New Delhi (Nominee of JS&FA, DBT)	-	Member (Ex-officio)
Prof Dipankar Chatterji IISc, Bangalore	-	Member
Shri K M Kutty Deputy Secretary, DBT, New Delhi (Nominee of Senior Scientist, DBT)	-	Member (Ex-officio)
Dr J Gowrishankar Director, CDFD, Hyderabad	-	Member
Joint Secretary & Financial Adviser Ministry of Home Affairs, New Delhi	-	Member (Ex-officio)
Shri B J Acharyulu Head - Finance & Accounts CDFD, Hyderabad	-	Member Secretary

MEMBERS OF CDFD BUILDING COMMITTEE

Prof V S Chauhan Director, ICGEB, New Delhi	-	Chairman
Dr J Gowrishankar Director, CDFD, Hyderabad	-	Member
Shri S Raghavan Joint Secretary, DBT, New Delhi	-	Member
Shri V H Rao Senior Consultant, NIAB, Hyderabad	-	Member
Shri J Sanjeev Rao Head - Administration, CDFD, Hyderabad	-	Member
Shri B J Acharyulu Head - Finance & Accounts, CDFD, Hyderabad	-	Member
Shri K Ananda Rao Senior Consultant (Engineering), CDFD, Hyderabad	-	Member Convenor

MEMBERS OF CDFD MANAGEMENT COMMITTEE

Dr J Gowrishankar Director	-	Chairperson
Dr J Nagaraju Staff Scientist	-	Member
Dr Ranjan Sen Staff Scientist	-	Member
Dr M V Subba Reddy Staff Scientist	-	Member
Shri B J Acharyulu Head - Finance & Accounts	-	Member
Shri J Sanjeev Rao Head - Administration	-	Member Convenor

सूचना अधिकार अधिनियम, 2005 का परिपालन
Implementation of RTI Act, 2005

IMPLEMENTATION OF RTI ACT, 2005

Appellate Authority:

Shekhar C Mande
J Sanjeev Rao (Since 22nd September 2011)

Central Public Information Officer:

J Sanjeev Rao
M Kavita Rao (Since 2nd May 2011)

Quarter: 1st Quarter Year 2011-2012

Details about the requests and appeals

Progress during Quarter						
	Opening Balance as on beginning of 1 st quarter	No. of applications received as transfer from other PAs u/s 6(3)	Received during the quarter (including cases transferred to other PAs)	No. of cases transferred to other PAs u/s 6(3)	Decisions where requests/appeals rejected	Decisions where requests/appeals accepted
Requests	0	1	14	0	3	10
First Appeals	1	N/A	0	N/A	0	0
	Total No. of CAPIOs designated		Total No. of CPIOs designated		Total No. of AAs designated	
	0		2		1	

Details about fee collected, penalty imposed and disciplinary action taken		
Registration Fee Collected (in Rs.) u/s 7(1)	Addl. Fee Collected (in Rs.) u/s 7(3)	Penalty Amount Recovered (in Rs.) as directed by CIC u/s 20(1)
120	32	0
		No. of cases where disciplinary action taken against any officer u/s 20(2)
		0

Quarter: 2nd Quarter Year 2011-2012

Progress during Quarter						
	Opening Balance as on beginning of 1 st quarter	No. of applications received as transfer from other PAs u/s 6(3)	Received during the quarter (including cases transferred to other PAs)	No. of cases transferred to other PAs u/s 6(3)	Decisions where requests/appeals rejected	Decisions where requests/appeals accepted
Requests	2	0	2	0	0	4
First Appeals	1	N/A	3	N/A	0	4
	Total No. of CAPIOs designated		Total No. of CPIOs designated		Total No. of AAs designated	
	0		2		1	

Details about fee collected, penalty imposed and disciplinary action taken			
Registration Fee Collected (in Rs.) u/s 7(1)	Addl. Fee Collected (in Rs.) u/s 7(3)	Penalty Amount Recovered (in Rs.) as directed by CIC u/s 20(1)	No. of cases where disciplinary action taken against any officer u/s 20(2)
20	0	0	0

Quarter: 3rd Quarter Year 2011-2012

Progress during Quarter						
	Opening Balance as on beginning of 1 st quarter	No. of applications received as transfer from other PAs u/s 6(3)	Received during the quarter (including cases transferred to other PAs)	No. of cases transferred to other PAs u/s 6(3)	Decisions where requests/appeals rejected	Decisions where requests/appeals accepted
Requests	0	0	8	0	0	3
First Appeals	0	N/A	0	N/A	0	0
	Total No. of CAPIOs designated		Total No. of CPIOs designated		Total No. of AAs designated	
	0		2		1	

169

Details about fee collected, penalty imposed and disciplinary action taken			
Registration Fee Collected (in Rs.) u/s 7(1)	Addl. Fee Collected (in Rs.) u/s 7(3)	Penalty Amount Recovered (in Rs.) as directed by CIC u/s 20(1)	No. of cases where disciplinary action taken against any officer u/s 20(2)
120	30	0	0

Quarter: 4th Quarter Year 2011-2012

Progress during Quarter						
	Opening Balance as on beginning of 1 st quarter	No. of applications received as transfer from other PAs u/s 6(3)	Received during the quarter (including cases transferred to other PAs)	No. of cases transferred to other PAs u/s 6(3)	Decisions where requests/appeals rejected	Decisions where requests/appeals accepted
Requests	5	1	6	0	2	10
First Appeals	0	N/A	1	N/A	0	1
	Total No. of CAPIOs designated		Total No. of CPIOs designated		Total No. of AAs designated	
	0		1		1	

170

Details about fee collected, penalty imposed and disciplinary action taken			
Registration Fee Collected (in Rs.) u/s 7(1)	Addl. Fee Collected (in Rs.) u/s 7(3)	Penalty Amount Recovered (in Rs.) as directed by CIC u/s 20(1)	No. of cases where disciplinary action taken against any officer u/s 20(2)
40	82	0	0

बजट एवं वित्त
Budget and Finance

CENTRE FOR DNA FINGERPRINTING AND DIAGNOSTICS HYDERABAD

Budget & Finance 2011-12

Sources of Funds

The Financial resources of the Centre are the Core Plan Grant-in-Aid provided by the Department of Biotechnology, Government of India as against Annual Budgetary projections made by the Institute. Other resources are in the form of Research Grants provided by various National and International agencies and also from services rendered by CDFD. The components of the core grants are Plan (Recurring) essentially for meeting expenditures on salaries, operating expenses, etc. and Plan (Non-Recurring) for meeting expenses on account of Equipments, Infrastructure and Furnishing etc.

Receipts during the year 2011-12

Particulars	Amount in Lakhs	Percentage %
Plan Grant-in-Aid	3802.00	64.72
Sponsored Projects	1894.31	32.24
CDFD Services	31.54	0.54
Misc. Receipts	146.67	2.50
Total	5874.52	100.00

I. Application of Funds during 2011-12 (Plan Grant-in-Aid)

S.No.	Particulars	Amount in Lakhs	Percentage %
1	Recurring		
	Salaries & wages	800.52	19.80
	Operating expenses	1501.30	37.14
	Total	2301.82	56.94
2	Non-Recurring		
	Equipments, Infrastructure & Furnishing	1740.72	43.06
	Total	1740.72	43.06
	Grand Total	4042.54	100.00

II. Application of Funds during 2011-12 (Extra Mural Projects)

S No	Particulars	Amount in Lakhs	Percentage %
1	Recurring		
	Salaries & wages	334.15	21.56
	Operating expenses	1064.38	68.70
	Total	1398.53	90.26
2	Non-Recurring		
	Equipments	150.90	9.74
	Total	150.90	9.74
	Grand Total	1549.43	100.00

लेखा परिक्षक की रिपोर्ट
Auditor's Report

BAPUJI & VENKAT

Chartered Accountants

AUDITOR'S REPORT

Date: 23-07-2012

The Director,
Centre for DNA Fingerprinting and Diagnostics,
Nampally, Hyderabad - 500 001

We have audited the attached Balance Sheet of **CENTRE FOR DNA FINGERPRINTING AND DIAGNOSTICS**, Hyderabad, as at 31st March 2012 and also the Income & Expenditure Account for the year ended on that date annexed there to. These financial statements are the responsibility of the organization management. Our responsibility is to express an opinion on these financial statements based on our audit.

We report that:

1. We have obtained all the information and explanations, which are to the best of our knowledge and belief, were necessary for the purpose of our audit.
2. In our opinion, the organization has kept proper books of account as required by law so far, as appears from our examination of those books.
3. The Balance sheet and Income & Expenditure account dealt with by this report in agreement with the books of account.
4.
 - (a) The centre has maintained accounts on Cash basis.
 - (b) The Centre receives extra mural grants from various National & International agencies for specific research activities. The Centre has a policy of allocating the overheads and transfer of expenditure of CDFD to different projects at the end of the financial year after taking into account the amount of maximum permissible limit of overheads and also based on the approved budget estimates of the respective projects during the financial year.
5. In our opinion and to the best of our information and according to the explanations given to us, the said Balance sheet and the Income & Expenditure account read together with the notes thereon gives the required information in the manner so required and give a true and fair view.
 - a) In so far it relates to the Balance Sheet of the state of the organization as at 31st March 2012 and
 - b) In so far as it relates to the Income & Expenditure account of the surplus of the organization for the year ended on 31st March 2012.

for **BAPUJI & VENKAT**
Chartered Accountants
[K VENKATACHARYULU]

Place: Hyderabad

Date: 23/07/2012

CENTRE FOR DNA FINGERPRINTING AND DIAGNOSTICS, HYDERABAD

BALANCE SHEET AS ON 31st MARCH, 2012

(Amount - Rs.)

CORPUS/CAPITAL FUND AND LIABILITIES	Schedule	Current Year	Previous Year
Corpus / Capital Fund	1	996575609	811485570
Reserves and Surplus	2	276778938	272022338
Earmarked / Endowment Funds	3	50698171	16210479
Secured Loans & Borrowings	4	0	0
Unsecured Loans & Borrowings	5	0	0
Deffered Credit Liabilities	6	0	0
Current Liabilities and Provisions	7	64107025	89226416
TOTAL		1388159744	1188944803
ASSETS			
Fixed Assets	8	1024083740	742922549
Investments - From Earmarked / Endowment Funds	9	62398273	78308000
Investments - Others	10	29159376	33724337
Current Assets, Loans, Advances etc.	11	270612851	332084413
Miscellaneous Expenditure			
Internal & External Electrification		1905503	1905503
TOTAL		1388159744	1188944803
Significant Accounting Policies	24		
Contingent Liabilities and Notes on Accounts	25		
DIRECTOR CDFD			
		HEAD - FINANCE & ACCOUNTS CDFD	
		for BAPUJI & VENKAT CHARTERED ACCOUNTANTS [K VENKATACHARYULU] Partner	

CENTRE FOR DNA FINGERPRINTING AND DIAGNOSTICS, HYDERABAD			
INCOME AND EXPENDITURE ACCOUNT FOR THE YEAR ENDING 31st MARCH, 2012			
(Amount - Rs.)			
INCOME	Schedule	Current Year	Previous Year
Income from Sales/Services	12	3158471.00	3545801.50
Grants/Subsidies	13	210200000.00	185000000.00
Fees/Subscriptions	14	0.00	0.00
Income from Investments	15	10566572.00	789164.00
Income from Royalty, Publications, etc.	16	0.00	0.00
Interest Earned	17	1254141.06	2552230.00
Other Income	18	2842632.60	288553.00
Increase/(decrease) in stock of Finished goods and works-in-progress	19	0.00	0.00
TOTAL (A)		228021816.66	192175748.50
EXPENDITURE			
Establishment Expenses	20	80052399.00	69488171.00
Administrative Expenses etc.	21	143212816.86	114154659.00
Expenditure on Grants, Subsidies etc.	22	0.00	0.00
Interest	23	0.00	0.00
Depreciation (Net Total at the year-end - corresponding to Schedule 8)			
TOTAL (B)		223265215.86	183642830.00
Balance being excess of Income over Expenditure (A-B)		4756600.80	8532918.50
Transfer to Special Reserve (Specify each)			
Transfer to / from General Reserve			
BALANCE BEING SURPLUS/(DEFICIT) CARRIED TO CORPUS/CAPITAL FUND	24		
SIGNIFICANT ACCOUNTING POLICIES	25		
CONTINGENT LIABILITIES AND NOTES ON ACCOUNTS			
DIRECTOR		HEAD - FINANCE & ACCOUNTS	
CD/DF			CD/DF
		for BAPUJI & VENKAT CHARTERED ACCOUNTANTS [K VENKATACHARYULU] Partner	

CENTRE FOR DNA FINGERPRINTING AND DIAGNOSTICS, HYDERABAD
RECEIPTS AND PAYMENTS ACCOUNT FOR THE YEAR ENDED 31st MARCH 2012

(Amount - Rs.)

RECEIPTS	Current Year	Previous Year	PAYMENTS	Current Year	Previous Year
1. Opening Balances					
a) Cash in hand	160550.00	65550.00	1. Expenses a) Establishment Expenses (corresponding to Schedule 20) b) Administrative Expenses (corresponding to Schedule 21) c) Schedule 22	80052399.00	69488171.00
b) Bank Balances	55687650.25 0.00	42391687.25 0.00		143212816.86 0.00	114154659.00 0.00
i) In current accounts	7645412.22	6860352.72			
ii) In deposit accounts					
iii) Savings accounts					
II. Grants Received			II. Payments made against funds for various projects (Name of the fund or project should be shown along with the particulars of payments made for each project)		
a) From Government of India	380200000.00	230000000.00	Projects (Annexure H)	154943838.00	87058572.00
b) From State Government	0.00	0.00	EMRC a/c (Stipend)	10949949.00	7346700.00
c) From other sources (details)			DBT A/c (Stipend)	3239590.00	2278102.00
(Grants for capital & revenue exp. To be shown separately)			IISc A/c (Stipend)	1869165.00	1298574.00
Research Associates - IISc (Stipend)	4385503.00	2059600.00	UGC A/c (Stipend)	4282140.00	1808382.00
Research Associates - UGC (Stipend)	8348180.00	0.00	DST Inspire (Stipend)	247039.00	17109.00
Research Associates - DBT-JRF(Stipend)	3477790.00	2861218.00	ICMR (Stipend)	1879593.00	1089703.00
Research Associates - EMRC (Stipend)	5197614.00	7268874.00			
Research Associates - DST-INSPIRE (Stipend)	250400.00	0.00			
Research Associates - ICMR (Stipend)	665590.00	954940.00	III. Investments and deposits made		
Projects (Annexure -D)	189431530.00	84793274.00	a) Out of Earmarked/Endowment funds	116714571.00	67500000.00
			b) Out of Own Funds (Investments-others)	0.00	0.00
III. Income on Investments from			IV. Expenditure on Fixed Assets & Capital Work-in-Progress		
a) Earmarked/Endow. Funds	10566572.00	789164.00	a) Purchase of Fixed Assets :		
b) Own Funds (Oth. Investment)	132624298.00	70000000.00	Books & Journals	1185197.00	853343.00
Investments cancelled			Equipment - Lab / Office / Furniture	113054138.00	30818937.00
IV. Interest Received			Non Consumables	18700.00	0.00
a) On Bank deposits	290557.06	229789.00	DG Set	19900000.00	0.00
b) Loans, Advances etc	18924.00	6308.00	b) Expenditure on Capital Work-in-progress: Building	149823117.00	12297977.00
Interest on HBA Advances					

DIRECTOR
CDFD

for BAPUJI & VENKAT
 CHARTERED ACCOUNTANTS
 [K VENKATACHARYULU]
 Partner

HEAD - FINANCE & ACCOUNTS
CDFD

CENTRE FOR DNA FINGERPRINTING AND DIAGNOSTICS, HYDERABAD
RECEIPTS AND PAYMENTS ACCOUNT FOR THE YEAR ENDED 31st MARCH 2012

(Amount - Rs.)

RECEIPTS	Current Year	Previous Year	PAYMENTS	Current Year	Previous Year
Interest earned on LC	963584.00	2322441.00			
Interest on Vehicle Advance	7883.00	4628.00			
Interest on Computer Advance	0.00	521.00			
V. Other Income (Specify)			V. Refund of surplus money/Loans		
Analysis Charges	3324036.00	3950970.50	a) To the Government of India	0.00	0.00
			b) To the State Government	0.00	0.00
			c) To other provides of funds	0.00	0.00
VII. Any other receipts (give details)			VI. Finance Charges (Interest)	0.00	0.00
I- Remittances (Annexure -A)	9309830.00	6585429.00			
TDS Recoveries (Annexure-B)	4740809.00	2804289.00			
CPF -Sub, Arrears and adv. Refund	7869743.00	6765955.00	VII. Other Payments (Specify)		
Sundry receipts	2466175.60	38031.00	Advances (Annexure - E)	62291324.00	61546466.00
Sale of Tender Forms	25000.00	77500.00	I-Remittances (Annexure - F)	9241586.00	6594485.00
Application Fees	284300.00	121090.00	TDS remitted (Annexure- G)	4709062.00	2708394.00
Guest House receipts	38300.00	27900.00	CPF A/c	7895131.00	6740541.00
Hostel receipts	2050.00	12575.00	New Pension Scheme	11649062.00	0.00
Loans & Advances (Recovery)- (Annexure - C)	146836613.00	59668099.00	Analysis Charges paid / refund	169325.00	405169.00
Asset Transfer	0.00	6749850.00	CDFD Revolving Fund Expenses a/c	2644290.00	120000.00
Indo-Australian Biotech Conference A/c	0.00	17832.00	Ramalingaswami Fellows Conclave	547219.00	0.00
Ramalingaswami Fellows Conclave	1700000.00	0.00	Workshop A/c expenses	248303.00	687047.00
Vehicles	0.00	10270.00	Asset Transfer	23456673.00	0.00
Sale of Scrap	3760.00	0.00	Indo-Australian Biotech Conference A/c	520343.00	88356.00
New Pension Scheme	11649062.00	0.00	Collaboration A/c Expenses	861906.00	0.00
Collaboration A/c receipts	0.00	46162.00			
Workshop A/c receipts	4142214.00	270000.00	VIII. Closing Balances		
Indo-Canada Workshop receipts	0.00	640000.00	a) Cash in hand	0.00	160550.00
			b) Bank Balances		
			i) In current accounts	71591437.99	55687650.25
			ii) In deposit accounts	0.00	0.00
			iii) Savings accounts	13026015.28	7645412.22
TOTAL	992313930.13	538394299.47	TOTAL	992313930.13	538394299.47

DIRECTOR
CDFD

for BAPUJI & VENKAT
 CHARTEREDACCOUNTANTS
 [K VENKATACHARYULU]
 Partner

HEAD - FINANCE & ACCOUNTS
 CDFD

CENTRE FOR DNA FINGERPRINTING AND DIAGNOSTICS, HYDERABAD		SCHEDULES FORMING PART OF BALANCE SHEET AS AT 31st MARCH 2012		(Amount - Rs.)	
		Current Year		Previous Year	
SCHEDULE 1 - CORPUS/CAPITAL FUND :					
Balance as at the beginning of the year					755462253.00
Add : Contribution towards Corpus/Capital Fund					
CDFD Core - Plan (Non-Recurring)		17000000.00		4500000.00	
Capitalised portion of fixed assets of projects		15090039.00		11023317.00	
Add : Balance of net income/(expenditure) transferred from the income and Expenditure Account					0.00
BALANCE AS AT THE YEAR END				996575609.00	811485570.00

CENTRE FOR DNA FINGERPRINTING AND DIAGNOSTICS, HYDERABAD

SCHEDULES FORMING PART OF BALANCE SHEET AS AT 31st MARCH 2012`

(Amount - Rs.)

	Current Year		Previous Year	
SCHEDULE 2 -RESERVES AND SURPLUS :				
1.Capital Reserve :				
As per last Account	0.00		0.00	
Addition during the year	0.00		0.00	
Less : Deductions during the year	0.00	0.00	0.00	0.00
2.Revaluation Reserve :				
As per last Account	0.00		0.00	
Addition during the year	0.00		0.00	
Less : Deductions during the year	0.00	0.00	0.00	0.00
3.Special Reserves :				
As per last Account	0.00		0.00	
Addition during the year	0.00		0.00	
Less : Deductions during the year	0.00	0.00	0.00	0.00
4.General Reserve :				
As per last Account	272022337.50		263489419.00	
Addition during the year	4756600.80		8532918.50	272022337.50
Less : Deductions during the year	0.00	276778938.30	0.00	0.00
TOTAL		276778938.30		272022337.50

CENTRE FOR DNA FINGERPRINTING AND DIAGNOSTICS, HYDERABAD		SCHEDULES FORMING PART OF BALANCE SHEET AS AT 31st MARCH 2012		(Amount - Rs.)	
SCHEDULE 3 - EARMARKED/ENDOWMENT FUNDS		Current Year		Previous Year	
(Refer Annexures P 03-P 144, COE I & II & A to M)					
(a) Opening balance of the funds			16210479.20		18475777.20
(b) Additions to the Funds :					
i. Donations /grants		189431530.00		84793274.00	
ii. Income from investments made on account of funds		0.00		0.00	
iii. Other additions		0.00	189431530.00	0.00	84793274.00
TOTAL (a+b)			205642009.20		103269051.20
(c) Utilisation/Expenditure towards objective of funds					
(i) Capital Expenditure (Refer Annexures I & II)					
- Fixed Assets		15090039.00		11023317.00	
- Others		0.00	15090039.00	6749850.00	17773167.00
Total					
(ii) Revenue Expenditure					
- Salaries, Wages and allowances etc.		33415240.00		23412168.00	
- Rent		0.00		0.00	
- Other Expenses		106438559.00	139853799.00	45873237.00	69285405.00
Total					
TOTAL (c)			154943838.00		87058572.00
NET BALANCE AS AT THE YEAR-END (a+b-c)			50698171.20		16210479.20

CENTRE FOR DNA FINGERPRINTING AND DIAGNOSTICS, HYDERABAD

SCHEDULES FORMING PART OF BALANCE SHEET AS AT 31st MARCH 2012

(Amount - Rs.)

	Current Year		Previous Year	
SCHEDULE 4 - SECURED LOANS AND BORROWINGS:				
1. Central Government		0.00		0.00
2. State Government (Specify)		0.00		0.00
3. Financial Institutions				
(a) Term Loans	0.00		0.00	
(b) Interest accrued and due	0.00	0.00	0.00	0.00
4. Banks				
(a) Term Loans	0.00		0.00	
- Interest accrued and due	0.00		0.00	
(b) Other Loans (specify)	0.00		0.00	
- Interest accrued and due	0.00	0.00	0.00	0.00
5. Other Institutions and Agencies		0.00		0.00
6. Debentures and Bonds		0.00		0.00
7. Others (Specify)		0.00		0.00
TOTAL		0.00		0.00
Note: Amount due within one year				

CENTRE FOR DNA FINGERPRINTING AND DIAGNOSTICS, HYDERABAD

SCHEDULES FORMING PART OF BALANCE SHEET AS AT 31st MARCH 2012

(Amount - Rs.)

	Current Year		Previous Year	
SCHEDULE 5 - UNSECURED LOANS AND BORROWINGS:				
1. Central Government		0.00		0.00
2. State Government (Specify)		0.00		0.00
3. Financial Institutions		0.00		0.00
4. Banks				
(a) Term Loans	0.00		0.00	
(b) Other Loans (specify)	0.00		0.00	
5. Other Institutions and Agencies		0.00		0.00
6. Debentures and Bonds		0.00		0.00
7. Fixed Deposits		0.00		0.00
8. Others (Specify)		0.00		0.00
TOTAL		0.00		0.00
Note: Amounts due within one year				

CENTRE FOR DNA FINGERPRINTING AND DIAGNOSTICS, HYDERABAD		
SCHEDULES FORMING PART OF BALANCE SHEET AS AT 31st MARCH 2012		
(Amount - Rs.)		
	Current Year	Previous Year
SCHEDULE6 - DEFERRED CREDIT LIABILITIES:		
(a) Acceptances secured by hypothecation of capital equipment and other assets	0.00	0.00
(b) Others	0.00	0.00
TOTAL	0.00	0.00
Note: Amount due within one year		

CENTRE FOR DNA FINGERPRINTING AND DIAGNOSTICS, HYDERABAD

SCHEDULES FORMING PART OF BALANCE SHEET AS AT 31st MARCH 2012

(Amount - Rs.)

	Current Year		Previous Year
SCHEDULE 7 - CURRENT LIABILITIES AND PROVISIONS			
A. CURRENT LIABILITIES			
1. Acceptances		0.00	0.00
2. Sundry Creditors		0.00	0.00
3. Advances Received		0.00	0.00
4. Interest accrued but not due on		0.00	0.00
5. Statutory Liabilities		0.00	0.00
6. Other current Liabilities			
CDFD CP Fund A/c (Annexure - I)	29159376.32	33724337.32	
Collabaration a/c	10600000.00	11461906.00	
Workshop a/c	4702674.50	808763.50	
Indo-Australian Biotech Conference A/c	0.00	520343.00	
CDFD Revolving Fund A/c	0.00	2644290.00	
Asset Transfer	0.00	23456673.00	
BOYSCOST Fellowship	17691.00	17691.00	
Amersham Biosciences (Maintenance)	500000.00	500000.00	
Swarnajayanthi Fellowship meeting	402040.00	402040.00	
Grant Host Meetings refundable	1033066.00	1033066.00	
T.D.S.Payable	386081.00	354334.00	
Other Loans	825.00	825.00	
CPF Subscription	0.00	34738.00	
Profession tax	3302.00	1371.00	
HSD , LSD & TSD	1010110.00	932750.00	
Security deposit/Retention money	1639975.00	1115975.00	
EMD / Margin money	3138534.00	5007156.00	
Works tax	234176.00	245349.00	
GSLI	27079.00	12455.00	
IISc Bangalore Stipend	4102405.00	1586067.00	
Vehicle Advance	72500.00	95000.00	

CENTRE FOR DNA FINGERPRINTING AND DIAGNOSTICS, HYDERABAD

SCHEDULES FORMING PART OF BALANCE SHEET AS AT 31st MARCH 2012

(Amount - Rs.)

	Current Year		Previous Year
SCHEDULE 7 - CURRENT LIABILITIES AND PROVISIONS			
Income Tax	76988.00		20406.00
Computer Advance - staff	75300.00		64100.00
Indo- US Workshop	1166374.00		1166374.00
DST Expert Meeting	200431.00		200431.00
Other receipts	600000.00		600000.00
HBA	95087.00		95087.00
Royalties & Consultancy	1548122.00		2554084.00
Indo Canada workshop	12784.00		551644.00
PPF	22890.00		19160.00
LIC	2550.00		0.00
TA/DA advance	116324.44		0.00
Ramalingaswami Fellows Conclave	1152781.00		0.00
UGC stipend	2007559.00	64107025.26	0.00
TOTAL (A)	64107025.26		89226415.82
B. PROVISIONS			
1. For Taxation	0.00		0.00
2. Gratuity	0.00		0.00
3. Superannuation/Pension	0.00		0.00
4. Accumulated Leave Encashment	0.00		0.00
5. Trade Warranties/Claims	0.00		0.00
6. Others (specify)	0.00	0.00	0.00
TOTAL (B)		0.00	0.00
TOTAL (A+B)	0.00	64107025.26	89226415.82

CENTRE FOR DNA FINGERPRINTING AND DIAGNOSTICS, HYDERABAD
SCHEDULES FORMING PART OF BALANCE SHEET AS AT 31st MARCH 2012

(Amount - Rs.)

SCHEDULE 8 - FIXED ASSETS	GROSS BLOCK				DEPRECIATION			NET BLOCK		
	Cost / valuation as at beginning of the year	Additions during the year	Deductions during the year	Cost / Valuation at the year end	As at the beginning of the year	On Additions during the year	On Deductions during the year	Total up to the year end	As at the Current year end	As at the Previous year end
A. FIXED ASSETS:										
1. LAND:										
a) Freehold	3900000.00	0.00	0.00	3900000.00	0.00	0.00	0.00	0.00	3900000.00	3900000.00
b) Leasehold	0.00	0.00	0.00	0.00	0.00	0.00	0.00	0.00	0.00	0.00
2. BUILDINGS:										
a) On Freehold Land	0.00	0.00	0.00	0.00	0.00	0.00	0.00	0.00	0.00	0.00
b) On Leasehold Land	0.00	0.00	0.00	0.00	0.00	0.00	0.00	0.00	0.00	0.00
c) Ownership Flats/Premises	0.00	0.00	0.00	0.00	0.00	0.00	0.00	0.00	0.00	0.00
d) Superstructures on Land	0.00	0.00	0.00	0.00	0.00	0.00	0.00	0.00	0.00	0.00
not belongs to the entity										
3. PLANT MACHINERY & EQUIPMENT	341306258.05	240159824.00	113130659.00	468335423.05	0.00	0.00	0.00	0.00	468335423.05	341306258.05
4. VEHICLES	4126158.00	0.00	0.00	4126158.00	0.00	0.00	0.00	0.00	4126158.00	4126158.00
5. FURNITURE, FIXTURES	15421247.00	1023934.00	0.00	16445181.00	0.00	0.00	0.00	0.00	16445181.00	15421247.00
6. OFFICE EQUIPMENT	11322421.00	91078.00	0.00	11413499.00	0.00	0.00	0.00	0.00	11413499.00	11322421.00
7. COMPUTER/PERIPHERALS	0.00	0.00	0.00	0.00	0.00	0.00	0.00	0.00	0.00	0.00
8. ELECTRIC INSTALLATIONS	336985.00	0.00	0.00	336985.00	0.00	0.00	0.00	0.00	336985.00	336985.00
9. LIBRARY BOOKS	13896379.00	1215316.00	30119.00	15081576.00	0.00	0.00	0.00	0.00	15081576.00	13896379.00
10. TUBEWELLS & WATER SUPPLY	0.00	0.00	0.00	0.00	0.00	0.00	0.00	0.00	0.00	0.00
11. OTHER FIXED ASSETS										
Airconditioning works	5337154.00	0.00	0.00	5337154.00	0.00	0.00	0.00	0.00	5337154.00	5337154.00
Aluminium partition work	1213252.00	0.00	0.00	1213252.00	0.00	0.00	0.00	0.00	1213252.00	1213252.00
DG Set	1646305.00	1990000.00	0.00	3636305.00	0.00	0.00	0.00	0.00	3636305.00	1646305.00
Paintings	40000.00	0.00	0.00	40000.00	0.00	0.00	0.00	0.00	40000.00	40000.00
Typewriters	42450.00	0.00	0.00	42450.00	0.00	0.00	0.00	0.00	42450.00	42450.00
Miscellaneous non consumables	957984.50	18700.00	0.00	976684.50	0.00	0.00	0.00	0.00	976684.50	957984.50
Other Assets	1018618.00	0.00	0.00	1018618.00	0.00	0.00	0.00	0.00	1018618.00	1018618.00
EMB Net	5229909.00	0.00	0.00	5229909.00	0.00	0.00	0.00	0.00	5229909.00	5229909.00
TOTAL	405795120.55	244498852.00	113160778.00	537133194.55	0.00	0.00	0.00	0.00	537133194.55	405795120.55
B. CAPITAL WORK-IN-PROGRESS	337127428.70	149823117.00	0.00	486950545.70	0.00	0.00	0.00	0.00	486950545.70	337127428.70
TOTAL	742922549.25	394321969.00	113160778.00	1024083740.25	0.00	0.00	0.00	0.00	1024083740.25	742922549.25

Note:- Out of the Total addition of Rs. 127120243/- the amount pertaining to Projects & Core Grants are as follows:-
Projects - Equipment 15090039.00
CDFD Core Grant 112030204.00

CENTRE FOR DNA FINGERPRINTING AND DIAGNOSTICS, HYDERABAD		(Amount - Rs.)	
SCHEDULES FORMING PART OF BALANCE SHEET AS AT 31st MARCH 2012			
SCHEDULE 9 - INVESTMENTS FROM EARMARKED/ENDOWMENT FUNDS		Current Year	Previous Year
1. In Government Securities		0.00	0.00
2. Other approved Securities		0.00	0.00
3. Shares		0.00	0.00
4. Debentures and Bonds		0.00	0.00
5. Subsidiaries and Joint Ventures		0.00	0.00
6. Others (to be specified) - STDRs (Annexure - L)		62398273.00	78308000.00
TOTAL		62398273.00	78308000.00

CENTRE FOR DNA FINGERPRINTING AND DIAGNOSTICS, HYDERABAD		(Amount - Rs.)	
SCHEDULES FORMING PART OF BALANCE SHEET AS AT 31st MARCH 2012			
SCHEDULE 10 - INVESTMENTS - OTHERS		Current Year	Previous Year
(Annexure - M)			
1. In Government Securities		0.00	0.00
2. Other approved Securities		0.00	0.00
3. Shares		0.00	0.00
4. Debentures and Bonds : UTI Bonds		936360.00	936360.00
5. Subsidiaries and Joint Ventures		0.00	0.00
6. Others (to be specified) - STDRs (CPF), CDFD CP FUND A/c		28223016.00	32787977.32
TOTAL		29159376.00	33724337.32

CENTRE FOR DNA FINGERPRINTING AND DIAGNOSTICS, HYDERABAD

SCHEDULES FORMING PART OF BALANCE SHEET AS AT 31st MARCH 2012

(Amount - Rs.)

	Current Year		Previous Year	
SCHEDULE 11 - CURRENT ASSETS, LOANS, ADVANCES ETC.				
A. CURRENT ASSETS:				
1. Inventors:				
a) Stores and Spares	0.00		0.00	
b) Loose Tools	0.00		0.00	
c) Stock-in-trade				
Finished Goods	0.00		0.00	
Work-in-progress	0.00		0.00	
Raw Materials	0.00	0.00	0.00	0.00
2. Sundry Debtors:				
a) Debts Outstanding for a period exceeding six months				
b) Others - Life Membership Fees	165935.00	165935.00	165935.00	165935.00
3. Cash balances in hand (including cheques/drafts and imprest)				160550.00
4. Bank Balances:				
a) With Scheduled Banks:				
-On Current Accounts	71591437.99		55687650.25	
-On Deposit Accounts (includes margin money)			0.00	
-On Savings Accounts	13026015.28	84617453.27	7645412.22	63333062.47
b) With non-Scheduled Banks:				
-On Current Accounts	0.00		0.00	
-On Deposit Accounts	0.00		0.00	
-On Savings Accounts	0.00	0.00	0.00	0.00
5. Post Office-Savings Accounts				
TOTAL (A)		84783388.27		63659547.47

CENTRE FOR DNA FINGERPRINTING AND DIAGNOSTICS, HYDERABAD

SCHEDULES FORMING PART OF BALANCE SHEET AS AT 31st MARCH 2012

(Amount - Rs.)

	Current Year		Previous Year	
SCHEDULE 11 - CURRENT ASSETS, LOANS, ADVANCES, ETC.				
B. LOANS, ADVANCES AND OTHER ASSETS				
1. Loans:				
a) Staff	0.00		0.00	
b) Other Entities engaged in activities/objectives similar to that of the Entity	0.00	0.00	0.00	0.00
2. Advances and other amounts recoverable in cash or in kind or for value to be received				
a) On Capital Account (Annexure - J)	171246087.95		249079458.51	
b) Prepayments - Deposits (Annexure- K)	14583375.00		19345407.00	
c) Others	0.00	185829462.95	0.00	268424865.51
3. Income Accrued:				
a) On Investments from Earmarked/Endowment Funds	0.00		0.00	
b) On Investments - Others	0.00		0.00	
c) On Loans and Advances	0.00		0.00	
d) Others	0.00	0.00	0.00	0.00
4. Claims Receivable				
TOTAL (B)		185829462.95		268424865.51
TOTAL (A+B)		270612851.22		332084412.98

CENTRE FOR DNA FINGERPRINTING AND DIAGNOSTICS, HYDERABAD		
SCHEDULES FORMING PART OF INCOME & EXPENDITURE AS AT 31st MARCH 2012		
	Current Year	Previous Year
	(Amount - Rs.)	
SCHEDULE 12 - INCOME FROM SALES/SERVICES		
1) Income from Sales		
a) Sale of Finished Goods	0.00	0.00
b) Sale of Raw Material	0.00	0.00
c) Sale of Scraps	3760.00	00.00
2) Income from Services		
a) Labour and Processing Charges	0.00	0.00
b) Professional/Consultancy Services (Analysis Charges)	3154711.00	3545801.00
c) Agency Commission and Brokerage	0.00	0.00
d) Maintenance Services (Equipment/Property)	0.00	0.00
e) Others (Specify)	0.00	0.00
TOTAL	3158471.00	3545801.00
SCHEDULE 13 - GRANTS/SUBSIDIES		
(Irrevocable Grants & Subsidies Received)		
1) Central Government (DBT Plan Grant-in-Aid)	210200000.00	185000000.00
2) State Government (s)	0.00	0.00
3) Government Agencies	0.00	0.00
4) Institutions/Welfare Bodies	0.00	0.00
5) International Organisations	0.00	0.00
6) Others (Specify)	0.00	0.00
TOTAL	210200000.00	185000000.00

CENTRE FOR DNA FINGERPRINTING AND DIAGNOSTICS, HYDERABAD		
SCHEDULES FORMING PART OF INCOME & EXPENDITURE AS AT 31st MARCH 2012		
(Amount - Rs.)		
SCHEDULE 14 - FEES/SUBSCRIPTIONS	Current Year	Previous Year
1) Entrance Fees	0.00	0.00
2) Annual Fees/Subscriptions	0.00	0.00
3) Seminar/Program Fees	0.00	0.00
4) Consultancy Fees	0.00	0.00
5) Others (Specify)	0.00	0.00
TOTAL	0.00	0.00

CENTRE FOR DNA FINGERPRINTING AND DIAGNOSTICS, HYDERABAD				
SCHEDULES FORMING PART OF INCOME & EXPENDITURE AS AT 31st MARCH 2012				
(Amount - Rs.)				
SCHEDULE 15 - INCOME FROM INVESTMENTS	Investment from Earmarked Fund		Investments - Others	
	Current Year	Previous Year	Current Year	Previous Year
(Income on Invest from Earmarked/Endowment Funds transferred to Funds)				
1) Interest				
a) On Govt. Securities	0.00		0.00	
b) Other Bonds/Debentures	0.00	0.00	0.00	0.00
2) Dividends				
a) On Shares	0.00		0.00	
b) On Mutual Fund Securities	0.00	0.00	0.00	0.00
3) Rents				
4) Others (Specify) STDRs	10566572.00	789164.00	0.00	0.00
TOTAL	10566572.00	789164.00	0.00	0.00
TRANSFERRED TO EARMARKED/ENDOWMENT FUNDS				

CENTRE FOR DNA FINGERPRINTING AND DIAGNOSTICS, HYDERABAD		
SCHEDULES FORMING PART OF INCOME & EXPENDITURE AS AT 31st MARCH 2012		
	Current Year	Previous Year
	(Amount - Rs.)	
SCHEDULE 16 - INCOME FROM ROYALTY, PUBLICATIONS ETC.		
1) Income from Royalty	0.00	0.00
2) Income from Publications	0.00	0.00
3) Others (Specify)	0.00	0.00
TOTAL	0.00	0.00

CENTRE FOR DNA FINGERPRINTING AND DIAGNOSTICS, HYDERABAD		
SCHEDULES FORMING PART OF INCOME & EXPENDITURE AS AT 31st MARCH 2012		
	Current Year	Previous Year
	(Amount - Rs.)	
SCHEDULE 17 - INTEREST EARNED		
1) On Term Deposits		
a) With Scheduled Banks	963584.00	82341.00
b) With Non-Scheduled Banks	0.00	0.00
c) With Institutions	0.00	0.00
d) Others	0.00	0.00
2) On Savings Accounts		
a) With Scheduled Banks	290557.00	116256.00
b) With Non-Scheduled Banks	0.00	0.00
c) Post Office Savings Accounts	0.00	0.00
d) Others	0.00	0.00
3) On Loans		
a) Employees/Staff	0.00	0.00
b) Others	0.00	0.00
4) Interest on Debtors and Other Receivables	0.00	0.00
TOTAL	1254141.00	198597.00
Note - Tax deducted at source to be indicated		

CENTRE FOR DNA FINGERPRINTING AND DIAGNOSTICS, HYDERABAD		
SCHEDULES FORMING PART OF INCOME & EXPENDITURE AS AT 31st MARCH 2012		
	Current Year	Previous Year
	(Amount - Rs.)	
SCHEDULE 18 - OTHER INCOME		
1) Profit on Sale/disposal of Assets:		
a) Owned assets	0.00	0.00
b) Assets acquired out of grants, or received free of cost	0.00	0.00
2) Export Incentives realized	0.00	0.00
3) Fees for Miscellaneous Services	0.00	0.00
4) Miscellaneous Income:		
Sundry receipts	2466175.60	38031.00
Sale of Tender forms	25000.00	77500.00
Guest House receipts	38300.00	27900.00
Hostel receipts	2050.00	12575.00
Application Fees	284300.00	121090.00
Interest on HBA Advance	18924.00	6308.00
Interest on Computer Advance	0.00	521.00
Interest on Vehicle Advance	7883.00	4628.00
TOTAL	2842632.60	288553.00

CENTRE FOR DNA FINGERPRINTING AND DIAGNOSTICS, HYDERABAD		
SCHEDULES FORMING PART OF INCOME & EXPENDITURE AS AT 31st MARCH 2012		
	Current Year	Previous Year
	(Amount - Rs.)	
SCHEDULE 19 - INCREASE/(DECREASE) IN STOCK OF FINISHED GOODS & WORK IN PROGRESS		
a) Closing stock		
-Finished Goods	0.00	0.00
-Work-in-progress	0.00	0.00
Total (a)	0.00	0.00
b) Less: Opening Stock		
-Finished Goods	0.00	0.00
-Work-in-progress	0.00	0.00
Total (b)	0.00	0.00
NET INCREASE/(DECREASE) [a-b]	0.00	0.00

CENTRE FOR DNA FINGERPRINTING AND DIAGNOSTICS, HYDERABAD		(Amount - Rs.)	
SCHEDULES FORMING PART OF INCOME & EXPENDITURE AS AT 31st MARCH 2012			
SCHEDULE 20 - ESTABLISHMENT EXPENSES		Current Year	Previous Year
a) Salaries and Wages		74470200.00	64482657.00
b) Allowances and Bonus		1597702.00	294502.00
c) Contribution to Provident Fund		2282201.00	2584414.00
d) Contribution to Other Fund (Specify)		0.00	0.00
e) Staff Welfare Expenses - Medical charges		1398440.00	1499162.00
f) Expenses on Employees Retirement and Terminal Benefits		303856.00	627436.00
g) Others (specify) - Staff leased House			0.00
TOTAL		80052399.00	69488171.00

CENTRE FOR DNA FINGERPRINTING AND DIAGNOSTICS, HYDERABAD
SCHEDULES FORMING PART OF INCOME & EXPENDITURE AS AT 31st MARCH 2012

		(Amount - Rs.)	
SCHEDULE 21 - OTHER ADMINISTRATIVE EXPENSES, ETC.		Current Year	Previous Year
1	Purchases (Consumables)	52186698.60	28907039.00
2	Labour and processing expenses	0.00	0.00
3	Cartage and Carriage Inwards	0.00	0.00
4	Electricity and power & Water Charges	18343015.00	15453669.00
5	Water charges	0.00	0.00
6	Insurance	0.00	
7	Repairs and Maintenance	21061051.00	17634146.00
8	Excise Duty	0.00	0.00
9	Rent, Rates and Taxes	17082514.00	16183639.00
10	Vehicles Running and Maintenance	873865.00	691891.00
11	Postage, Telephone and Communication Charges	1993049.00	2090345.00
12	Printing and Stationary	1238899.00	1297775.00
13	Travelling and Conveyance Expenses	6189789.26	7455620.00
14	Expenses on Seminar/Workshops	611987.00	0.00
15	Subscription Expenses	21932.00	34941.00
16	Expenses on Fees (Membership Fees)	348971.00	55915.00
17	Auditors Remuneration	27395.00	19854.00
18	Hospitality Expenses (Meeting Expenses)	1123155.00	1042842.00
19	Professional Charges (Legal Expenses incl. Patent charges)	2555345.00	3974647.00
20	Provision for Doubtful Debts/Advances - Workshop	0.00	0.00
21	Irrecoverable Balances Written-off	0.00	0.00
22	Packing Charges	0.00	0.00
23	Freight and Forwarding Expenses	0.00	0.00
24	Distribution Expenses	0.00	0.00
25	Advertisement and Publicity	3294255.00	6176174.00

CENTRE FOR DNA FINGERPRINTING AND DIAGNOSTICS, HYDERABAD			
SCHEDULES FORMING PART OF INCOME & EXPENDITURE AS AT 31st MARCH 2012			
(Amount - Rs.)			
SCHEDULE 21 - OTHER ADMINISTRATIVE EXPENSES, ETC.		Current Year	Previous Year
26	Hindi / Foundation day expenses	69792.00	11580.00
27	Bank charges	6864.00	3881.00
28	Security & Cleaning contract charges	14901941.00	12980676.00
29	Internet leased line charges	1114030.00	13500.00
30	Training Course / Symposia	168269.00	126525.00
TOTAL		143212816.86	114154659.00

CENTRE FOR DNA FINGERPRINTING AND DIAGNOSTICS, HYDERABAD			
SCHEDULES FORMING PART OF INCOME & EXPENDITURE AS AT 31st MARCH 2012			
(Amount - Rs.)			
SCHEDULE 22 - EXPENDITURE ON GRANTS, SUBSIDIES, ETC.		Current Year	Previous Year
a) Grants given to Institutions/Organisations		0.00	0.00
b) Subsidies given to Institutions/Organisations		0.00	0.00
TOTAL		0.00	0.00

CENTRE FOR DNA FINGERPRINTING AND DIAGNOSTICS, HYDERABAD			
SCHEDULES FORMING PART OF INCOME & EXPENDITURE AS AT 31st MARCH 2012			
(Amount - Rs.)			
SCHEDULE 23 - INTEREST		Current Year	Previous Year
a) On Fixed Loans		0.00	0.00
b) On Other Loans (including Bank Charges)		0.00	0.00
c) Others		0.00	0.00
TOTAL		0.00	0.00

**Schedule 24: Significant Accounting Policies, and
Schedule 25: Contingent Liabilities & Notes on Account
for the period ended 31/03/2012**

1. Method of Accounting:

- a. The accounting system adopted by the organization is on "Cash basis".
- b. The organization has been allocating plan grant-in-aid under the "Non-recurring" & "Recurring" heads.

2. Revenue recognition:

Income comprises of Grant-in-Aid, Internal resources through services and interest from short term deposits. Income accounted on the basis of the Cash/DD/Cheques/Cr notes received.

3. Fixed Assets:

- (a) Fixed assets are stated at cost. Cost includes freight, duties, and taxes etc.
- (b) Depreciation: No depreciation on the fixed assets is charged and as such no ageing of fixed assets are being done.
- (c) Capital work in progress has been entered to the extent of the last running account bills paid.
- (d) Realization on sale of obsolete/surplus fixed assets which is not required for the purpose of research activities are adjusted against capital cost.

4. Inventories:

All purchases of chemicals, glassware and other consumables have been charged to consumption at the time of purchase.

5. Foreign Currency transactions:

Foreign Currency transactions are recognized in the books at the exchange rates prevailing on the date of transaction.

6. Investments:

Investments in STDR's are stated at book values.

7. Advances:

It is observed from the objection book register that advances to suppliers for consumables & equipments are to be reconciled and adjustment entries are to be passed in the books of accounts.

8. The previous year balances have been regrouped/rearranged, wherever necessary.

Director, CDFD

Head Finance & Accounts

for **Bapuji & Venkat**
Chartered Accountants
[K VENKATACHARYULU]

Place: Hyderabad

Date: 23/07/2012

CENTRE FOR DNA FINGERPRINTING AND DIAGNOSTICS, HYDERABAD

CLARIFICATION ON NOTES ON ACCOUNTS: 2011-12

- ❖ Notes on Accounts 1 to 6 & 8: Method of Accounting/ Revenue recognition/Fixed Asset/Inventories/ Foreign Currency transactions/Investments:

These are all only informatory items.

- ❖ Notes on Accounts 7: Advances:

The observation of the audit has been noted. The action has already been initiated to reconcile the objection book register.

B. J. ACHARYULU

Head, Finance & Accounts,
CDFD

CENTRE FOR DNA FINGERPRINTING AND DIAGNOSTICS
Details of closing balances of various Earmarked / Endowment Funds (Refer Sch-3)
for the year ended 31st March 2012

Amount in Rs.

Previous year	P No	Particulars	Current Year
-630047.00	P-03	"Transgenesis and Genetic basis of Pathogen Resistance in the Silkworm, Bombyx Mori	-630047.00
0.00	P-04	"Silkworm Breeding for Productivity improvement of silk	0.00
244305.00	P-09	"NMITLI Project on – Latent M.Tuberculosis: New targets, Drug delivery systems, Bio enhancers & Therapeutics"	244305.00
-28332.00	P-10	"Role of upstream sequence elements in Hyper activation of transcription from Baculovirus polyhedrin gene promoter"	-28332.00
6737.00	P-13	"Programme to delineate gene functions in the post – genomics era by a systematic two gene knockout method"	6737.00
0.00	P-15	"The Helicobacter Pylori genome programme – Genome sequencing, functional analysis and comparative genomics of the strains obtained from Indian patients"	0.00
-687887.00	P-17	"Studies on inositol-phosphate synthesis – a novel enzyme from Mycobacterium tuberculosis H37RV" – Transfer from IMTECH, Chandigarh	-687887.00
-274286.00	P-18	"Mapping of receptor binding site on the Eythrocyte binding of malaria parasite"	-274286.00
0.00	P-19	"Construction of Integrated RAPD, RFLP and Microsatellite linkage map of the Silkworm, Bombyx mori and its corelation with the Phenotypic linkage Map"	0.00
-1888111.00	P-20	"Genomic Micro array R&D Programmes on infectious diseases and Neurological Disorders"	-1888111.00
0.00	P-21	Development of Versatile, portable software for Bio-informatics	0.00
-34495.00	P-23	"Development of PCR base assays for detection of GMO'S"	-34495.00
-529111.00	P-25	"Functional studies of Human Immuno - deficiency Virus Type– 2 (HIV-2) Viral protien X (VPX)"	-529111.00
-79533.00	P-26	Occurrence of Mutations in Non dividing cells of Escherichia Coli"	-79533.00
-37624.00	P-28	Baculovirus resistance in transgenic silkworms	-37624.00
-310302.00	P-29	"Development of Hospital Surveillance system by advanced diagnostics method & Molecular DNA fingerprinting techniques"	-310302.00
2045696.00	P-30	"Transcription termination and anti termination in E. Coli"	2045696.00
746453.00	P-31	Role of K-ras in Lung type II epithelial cells	746453.00
-234000.00	P-33	"Molecular and Epidemiological characterisation of cryptosporidium – An enteric protozoon parasite"	-234000.00
26334.00	P-34	"Molecular analysis of lepidopteran – specific immune protiens from silkmoths"	26334.00
-283883.00	P-35	"Identification, Characterization and Physical mapping of Z-Chromosome linked genes of the silk worm, Bombyxmori"	-283883.00
2073896.00	P-36	"Development of Artificial retina using Bacterio rhodospin and genetically engineered analogues "	2073896.00
-226058.00	P-40	"Antioxidants as a potential immuno adjuvant in anti tuberculosis immunotherapy"	-226058.00
1873605.00	P-41	"Construction, characterization and analysis of expressed sequences from silkworm "	1873605.00
-2237285.00	P-42	"Structural and functional studies on Mycobacterium tuberculosis heat shock proteins".	-2237285.00
685906.70	P-43	"A generalized mechanism of transcription termination in prokaryotes: a quest for mechanism based transcription inhibitors for microbial pathogens".	685906.70
-457538.00	P-44	"Understanding of role of Ras and NO / iNOS signalling in promotion of hepatocellular carcinomas with persistent HBV infection"	-457538.00
605714.00	P-45	Specialized chromatin structures as epigenetic imprints to distinguish parental alleles".	605714.00
0.00	P-46	"Effect of reactive oxygen species (ROS) on immune response : Relevance in immunosuppression and Pathogenesis"	0.00
-1586965.00	P-47	Research cum Training for DRDO Programme	-1586965.00
151826.00	P-48	"Molecular characterization of human liver stem cells for use in the treatment of hepatic diseases".	151826.00
0.00	P-49	"The Mycobacterium W genome program : Complete genome sequencing and comparative genomics"	0.00
470313.00	P-49A	Grant sanctioned by International Atomic Energy	440950.00
0.00	P-50	"Cervical cancer prevention by multiple strategies in rural community in Andhra pradesh"	0.00
-284065.00	P-51	"Understanding the mechanism of doxorubicin resistance in breast cancer celline MCF-7"	-284065.00
-1231118.00	P-52	"Nucleo Cytoplasmic transport of HIV – 1 Vpr"	-1231118.00
0.00	P-53	Collaborative research project on molecular ecology and systematics	0.00
-37877.00	P-54	"Study of viability of Mycobacterium leprae in clinical samples and possibility of its presence in the environment using nucleic acid amplification techniques."	-37877.00
224.00	P-55	"Identification of DNA Markers for baculovirus resistance in silkworm, Bombyx mori"	224.00
-1231164.00	P-56	"Genetics of transcription-replication interplay and of stress adaptation in bacteria"	-1231164.00
0.00	P-57	Improved genome annotation through a combination of machine learning and experimental methods: Plasmodium falciparum as a case study.	0.00
0.00	P-58	"Indo-Malaysian collaboration in Bioinformatics: Development and maintenance of a web-portal hosting databases and tools of common interest"	0.00
0.00	P-58A	Functional Genomics on Rice	0.00
-2215024.00	P-59	"An integrated Approach towards understanding the biology of Mycobacterium tuberculosis: Genetic, biochemical, immunological and structural analyses."	-2215024.00
482124.00	P-60	"National Database of Prevalent Genetic Disorders in India: Development, Curation and Services"	482124.00
-280000.00	P-61	"Dissection of a novel phenotype of lethal accumulation of potassium in Escherichia coli mutants defective in thioredoxin/thioredoxin reductase and nucleioeid protein H-NS"	-280000.00
-278928.00	P-62	"HIV – 1 Pathogenesis: Role of Integrate in Reverse Transcription and Nuclear Transport of Viral Genome"	-278928.00

CENTRE FOR DNA FINGERPRINTING AND DIAGNOSTICS
Details of closing balances of various Earmarked / Endowment Funds (Refer Sch-3)
for the year ended 31st March 2012

Amount in Rs.

Previous year	P No	Particulars	Current Year
-837574.00	P-63	"Upgradation of the existing computing infrastructure at the Bioinformatics facility at CDFD"	-837574.00
-158.00	P-64	Biotechnology for Leather: Towards cleaner processing phase-II	-158.00
-582647.00	P-65	"Molecular, genetic and functional analysis of the chromosomal plasticity region of the gastric pathogen Helicobacter pylori"	-582647.00
16381715.00	P-65A	APEDA - CDFD Centre for Basmati DNA Analysis	18938021.00
-681246.00	P-66	Human Epigenome Variation: Analysis of CpG island methylation in chromosomes 18 and Y, and in some Hox, insulin signaling and chromatin reprogramming genes	-681246.00
-113545.00	P-67	Identification of novel Esophageal Squamous cell carcinoma (ESCC) genes by using a combination of array-based CGH and gene expression micro arrays	-113545.00
-59874.00	P-68	Identification of High risk individual with pre-cancerous states of esophageal cancer.	-59874.00
0.00	P-69	ICMR adhoc New Scheme 'Understanding the role of PE/PPE family of M tuberculosis in the activation of HIV virus type I long terminal repeat (HIV-ILTP)	0.00
-21336.00	P-70	Identification of disease causing mutations in familial hypertrophic cardiomyopathy (FHC) patients from Andhra Pradesh	-21336.00
-591490.00	P-71	Referral Centre for Genetic fidelity testing of tissue culture raised plants	15829.00
-1421653.00	P-72	Nuances of Non coding DNA near insulin-responsive genes	-1421653.00
-857136.00	P-73	Identification and characterization of pancreatic cancer genes located within novel localized copy number alterations	-857136.00
0.00	P-74	Molecular basic of insect plant interactions in rice under the national fund for basic and strategic research in agriculture	0.00
-10840.00	P-75	Preparing blueprint for the macromolecular crystallography beamline at Indus-II synchrotron source	-10840.00
-50234.00	P-76	A study of Molecular Markers in childhood Autism with special references to nuclear factors - APPA B"	-50234.00
124277.00	P-77	Functional characterization of Mycobacterium tuberculosis PE/PPE proteins having SH3 binding domain: Understanding their role in modulating macrophage functions	124277.00
1304.00	P-78	Task Force - IMD Newborn Screening for Congenital Hypothyroidism & Congenital Adrenal Hyperplasia: A Multicentric Study"	1304.00
-1900986.00	P-79	Understanding the role of AGE proteins in inducing inflammatory responses and its regulation	-105086.00
-53994.00	P-80	Referral Centre for Detection of Genetically Modified Foods employing DNA - based Markets	-608222.00
0.00	P-80A	Fluorescent amplified fragment length polymorphism analysis of different genomic species - development of species specific markers for the identification of Leptospirosis	0.00
-13198864.00	COE-I	COE for Genetics and Genomics of silkworms	-3110519.00
214215.00	P-81	Reconstructing cellular Networks: Two-Component Regulatory Systems	143470.00
107800.00	P-81A	Financial Assistance for award of JC Bose Fellowship to Dr J Gowrishankar	62620.00
423591.00	P-82	Functional Genomic Analysis of Candida Glabrata-macrophage	155859.00
-1155594.00	P-83	Prokaryotic Transcription Termination Factor, Rho: Mechanism of Action and Biology	-1155594.00
-126140.00	P-83A	Understanding the mechanism of Azadirachtin-mediated cell signaling: role in anti-inflammation and anti-tumorigenesis	-126140.00
-1150.00	P-84	Preparing for tuberculosis vaccine efficacy trials: Baseline epidemiology, improved diagnosis, markers of protection and phase I/II trials	-1150.00
676641.00	P-84A	Human epigenetic to the rescue of Human Identification process: Enriching human DNA from DNA mixture employing antibodies directed against 5-methylcytosine followed by whole genome amplification	-106479.00
-1118755.00	P-85	IdeR associated gene regulatory network in mycobacteria	-1118755.00
0.00	P-86	Evaluation of Mycobacterium W as an immunotherapeutic against paratuberculosis (John's Disease of cattle)	0.00
-65698.00	P-87	Comparative genomic of wild silkworms under India-Japan Co-operative Science programme (IJCSP)	-65698.00
-4591687.00	COE-II	DBT Centre of Excellence for Microbial Biology	-8969700.00
740000.00	P-88	Financial Assistance for award of TATA Innovation Fellowship to Dr J Nagaraju	0.00
-300000.00	P-89	Characterization of Mycobacterium tuberculosis transcription machinery and Bacteriophage metagenomics	0.00
-451999.00	P-90	Role of Yapsins in the Pathobiology of Candida Glabrata	-636286.00
-787064.00	P-91	DNMT3L: Epigenetic correlation with cancer	-1098900.00
-1238545.00	P-92	Swarnajayanti Fellowship: Designing transcription anti-terminators: a novel approach for making new inhibitors of gene expression	-1260461.00
-684179.00	P - 93	Virtual Centre of Excellence on multidisciplinary approaches aimed at interventions against tuberculosis	-1506886.00
424041.00	P - 95	Construction of regulatory networks in prokaryotes through protein: Protein interaction predictions and transcription regulation predictions.	0.00
-655942.00	P - 96	Molecular Characterization of sporadic colorectal cancer in the young from India	0.00
488524.00	P - 97	Proteome-wide Analysis of Serine pyrophosphorylation by inositol pyrophosphates	-98464.00
-466554.00	P - 98	Role of cell - cell signaling mediated by Diffusible signaling factor (DSF) in Xanthomonas virulence	-63019.00
-113757.00	P - 99	Role of inositol Pyrophosphates in eukaryotic cell growth, proliferation and ribosome biogenesis	-1261900.00
-300000.00	P - 100	Effect of reactive oxygen species on T-Cell immune response: An approach to understand the molecular mechanism of immunosuppression during tuberculosis" - National Bioscience Award	-335000.00
15688931.00	P - 101	Role of inositol pyrophosphates in cell physiology: Investigating the biochemical significance of protein pyrophosphorylation - Senior Fellowship	13729401.00

CENTRE FOR DNA FINGERPRINTING AND DIAGNOSTICS
Details of closing balances of various Earmarked / Endowment Funds (Refer Sch-3)
for the year ended 31st March 2012

Amount in Rs.

Previous year	P No	Particulars	Current Year
-445133.00	P - 102	Understanding the role of Mycobacterium tuberculosis heat shockprotein 60 as Th1/Th2 immuno modular	82654.00
0.00	P - 103	National Bioscience Award - Regulation of mast cell signaling, apoptosis and surface receptors	-300000.00
297613.00	P-104	Virtual Centre of Excellence on Epigenetics - Project 4: Epigenetic dynamics in cell types and its potential association with environment and disease	-1394866.00
145971.00	P-105	Cloning, Characterisation and analysis of chromosomal rearrangements in human genetic disorders	-90844.00
-446056.00	P-106	Clinical, Biochemical and Molecular analysis of Treatable Lysosomal storage Disorders	190952.00
602006.00	P-107	IYBA Project - Mechanism and role of bacterial cell-cell signaling molecules in plant defense response	63600.00
184023.00	P-108	Establishment of EBV transformed cell lines from families with rare genetic disorders	69925.00
1476104.00	P-109	Molecular dissection of PI3-Kinase/Akt pathway by using proteomics based approach: A study to identify novel potential oncogenes and tumor suppressors	315626.00
24389.00	P-110	India-Japan research project title"Identification and analysis of sex determining genes in silkmoths"	-168679.00
488631.00	P-111	Ramalingaswami Fellowship - Refractoriness mechanism in Mosquito: cracking molecular codes at genomic scale	431731.00
803726.00	P-112	Ramanujan Fellowship	0.00
550715.00	P-113	Clinical and molecular genetic analysis of squamous cell carcinoma of the tongue	534630.00
1532761.00	P-114	Evaluating the Calcineurin-NFAT Pathway and its regulators superoxide dismutase (SOD) AND RCAN1 (regular of Calcineurin) Down Syndrome	51553.00
4559305.00	P-115	Setting up of the National Institute of Animal Biotechnology	8039741.00
1692817.00	P-116	DBT-India and AIST - Japan : Understanding molecular mechanisms controlling dual role of Ras, Sirtuins and CARF in relation to cellular proliferation and senescence: Novel Strategy for developing cancer therapeutics	-288420.00
5251500.00	P-117	Joint New Indigo Era-Net project titled "Mycobacterium Tuberculosis:bioinformatic and structural strategies towards treatment	0.00
1115770.00	P-118	Construction of regulatory networks in Mycobacterium tuberculosis through analysis of gene expression data and transcription regulation predictions. (MOU with Russian Foundation)	0.00
560342.00	P-119	Analysis of DNA copy number alterations in esophageal cancer	-738605.00
617000.00	P-120	Effect of reactive oxygen species on macrophage signalosome: impact on antigen presentation functions and T Cell priming responses	124600.00
37096.00	P-121	Identification and characterization of PTEN regulators	-597186.00
0.00	P-122	Understanding the role of Hox genes in anterior-posterior axis determination of the central nervous system	11479043.00
0.00	P-123	Establishment and Implementation of the Indo-German DST -MPG (Max Planck Society) Partner Group on Genetic Diversity Studies	2074056.00
0.00	P-124	Preparation and characterization of peroxometal compounds and studies and their biological significance in cellular signalling	167284.00
0.00	P-125	Mechanistic studies on the role of protein kinase Snf1 in cell cycle and cancer	154000.00
0.00	P-126	Rho-dependent transcription termination machinery: mechanism of action	1581615.00
0.00	P-127	Systematic studies on the functional network of phosphatases in cell life and death	5052715.00
0.00	P-128	Mechanism of iron acquisition and iron homeostasis in an opportunistic human pathogen Candida glabrata	2053587.00
0.00	P-129	Discovery of bioactive natural products from microbes especially actinomycetes in niche biotopes in Manipur	306000.00
0.00	P-130	Comparative genetic analysis of sex chromosomes and sex determining genes in silkmoths	4187000.00
0.00	P-131	Structural and functional studies of Acyl CoA Binding proteins from plasmodium falciparum	1182935.00
0.00	P-132	Characterization of tumor suppressor function of ARID1B, a component of the human SWI/SNF chromatin remodelling complex	634323.00
0.00	P-133	Investigating the role of Hox gene deformed in central nervous system patterning in Drosophila melanogaster	1549000.00
0.00	P-134	Exploration of wild silk moth biodiversity in Manipur and their genetic characterization using molecular markers	254000.00
0.00	P-135	Sys TB: A Network Program for Resolving the Intracellular Dynamics of Host Pathogen Interaction in TB infection	7418200.00
0.00	P-136	Raf Kinase - a key target for modern-day therapy against tumors	837200.00
0.00	P-137	Signaling pathways involved in down regulation of proinflammatory responses by PPE18 protein of Mycobacterium tuberculosis: Implication of PPE18 as therapeutics"	1500000.00
0.00	P-139	Evaluating the role of Sirtuins and epigenetic changes during cellular senescence in context of p53 status	2467200.00
0.00	P-144	Tri-National Training Program for Psychiatric Genetics	267184.00
16210479.20	Total		50698171.20

CENTRE FOR DNA FINGERPRINTING AND DIAGNOSTICS
Details of Fixed Assets Fund (Capitalised portion of Project Grants)
for the year ended 31st March 2012

Amount in Rs.

Previous year	P No	Particulars	Current Year
600000.00	P-03	"Transgenesis and Genetic basis of Pathogen Resistance in the Silkworm, Bombyx Mori	600000.00
329289.00	P-07	"Collection of well characterised clinical samples and strains of Mycobacterium tuberculosis and development of molecular techniques for detection of drug resistant strains – Multi Centric Project"	329289.00
588400.00	P-09	"NMITLI Project on – Latent M.Tuberculosis: New targets, Drug delivery systems, Bio enhancers & Therapeutics"	588400.00
47400.00	P-10	"Role of upstream sequence elements in Hyper activation of transcription from Baculovirus polyhedrin gene promoter"	47400.00
529750.00	P-12	Molecular genetics and Functional genomics of M.Tuberculosis patient isolates in India	529750.00
1334600.00	P-13	"Programme to delineate gene functions in the post – genomics era by a systematic two gene knockout method"	1334600.00
5163243.00	P-14	"Comparative and functional genomics approaches for the identification and characterization of genes responsible for multi drug resistance of mycobacterium tuberculosis"	5163243.00
6000000.00	P-15	"The Helicobacter Pylori genome programme – Genome sequencing, functional analysis and comparative genomics of the strains obtained from Indian patients"	6000000.00
1814901.00	P-16	NMITLI Project on – Latent M.Tuberculosis: New targets, Drug delivery systems, Bio enhancers & Therapeutics	1814901.00
244400.00	P-17	"Studies on inositol-phosphate synthesis – a novel enzyme from Mycobacterium tuberculosis H37RV" – Transfer from IMTECH, Chandigarh	244400.00
344020.00	P-18	"Mapping of receptor binding site on the Erythrocyte binding of malaria parasite"	344020.00
7246511.00	P-19	"Construction of Integrated RAPD, RFLP and Microsatellite linkage map of the Silkworm, Bombyx mori and its correlation with the Phenotypic linkage Map"	7246511.00
27331134.00	P-20	"Genomic Micro array R&D Programmes on infectious diseases and Neurological Disorders"	27331134.00
5300000.00	P-21	Development of Versatile, portable software for Bio-informatics	5300000.00
603747.00	P-22	"Biotechnology for leather – towards cleaner processing"	603747.00
375999.00	P-23	"Development of PCR base assays for detection of GMO'S"	375999.00
600000.00	P-25	"Functional studies of Human Immuno - deficiency Virus Type- 2 (HIV-2) Viral protein X (VPX)"	600000.00
500000.00	P-26	Occurrence of Mutations in Non dividing cells of Escherichia Coli"	500000.00
260367.00	P-29	"Development of Hospital Surveillance system by advanced diagnostics method & Molecular DNA fingerprinting techniques"	260367.00
3746538.00	P-30	"Transcription termination and anti termination in E. Coli"	3746538.00
3131006.00	P-31	Role of K-ras in Lung type II epithelial cells	3131006.00
4857938.00	P-36	"Development of Artificial retina using Bacterio rhodospin and genetically engineered analogues "	4857938.00
358470.00	P-39	"Computational analysis and functional characterization of mycobacterial protein(s) interacting with macrophage effector – APC functions – an approach to understand the molecular basis of pathogenesis of M. tuberculosis"	358470.00
49738.00	P-40	"Antioxidants as a potential immuno adjuvant in anti tuberculosis immunotherapy"	49738.00
3894086.00	P-41	"Construction, characterization and analysis of expressed sequences from silkworm "	3894086.00
9500000.00	P-42	"Structural and functional studies on Mycobacterium tuberculosis heat shock proteins".	9500000.00
11970000.00	P-43	"A generalized mechanism of transcription termination in prokaryotes: a quest for mechanism based transcription inhibitors for microbial pathogens".	11970000.00
3331377.00	P-45	Specialized chromatin structures as epigenetic imprints to distinguish parental alleles".	3331377.00
416137.00	P-46	"Effect of reactive oxygen species (ROS) on immune response : Relevance in immunosuppression and Pathogenesis"	416137.00
377567.00	P-47	Research cum Training for DRDO Programme	377567.00
1413292.00	P-48	"Molecular characterization of human liver stem cells for use in the treatment of hepatic diseases".	1413292.00
198095.00	P-50	"Cervical cancer prevention by multiple strategies in rural community in Andhra Pradesh"	198095.00
401738.00	P-51	"Understanding the mechanism of doxorubicin resistance in breast cancer celline MCF-7"	401738.00
1359129.00	P-52	"Nucleo Cytoplasmic transport of HIV – 1 Vpr"	1359129.00
1114495.00	P-53	Collaborative research project on molecular ecology and systematics	1114495.00
1163764.00	P-56	"Genetics of transcription-replication interplay and of stress adaptation in bacteria"	1163764.00
2131403.00	P-57	Improved genome annotation through a combination of machine learning and experimental methods: Plasmodium falciparum as a case study.	2131403.00
63000.00	P-58	"Indo-Malaysian collaboration in Bioinformatics: Development and maintenance of a web-portal hosting databases and tools of common interest"	63000.00
32974662.00	P-59	"An integrated Approach towards understanding the biology of Mycobacterium tuberculosis: Genetic, biochemical, immunological and structural analyses."	32974662.00
5720800.00	P-60	"National Database of Prevalent Genetic Disorders in India: Development, Curation and Services"	5720800.00
4308314.00	P-62	"HIV – 1 Pathogenesis: Role of Integrate in Reverse Transcription and Nuclear Transport of Viral Genome"	4308314.00
9637574.00	P-63	"Upgradation of the existing computing infrastructure at the Bioinformatics facility at CDFD"	9637574.00
600585.00	P-64	Biotechnology for Leather: Towards cleaner processing phase-II	600585.00
260000.00	P-65	"Molecular, genetic and functional analysis of the chromosomal plasticity region of the gastric pathogen Helicobacter pylori"	260000.00
16921476.00	P-65A	APEDA - CDFD Centre for Basmati DNA Analysis	16921476.00
264430.00	P-66	Human Epigenome Variation: Analysis of CpG island methylation in chromosomes 18 and Y, and in some Hox, insulin signaling and chromatin reprogramming genes	264430.00
622747.00	P-67	Identification of novel Esophageal Squamous cell carcinoma (ESCC) genes by using a combination of array-based CGH and gene expression micro arrays	622747.00
235593.00	P-69	ICMR adhoc New Scheme 'Understanding the role of PE/PPE family of M tuberculosis in the activation of HIV	

CENTRE FOR DNA FINGERPRINTING AND DIAGNOSTICS
Details of Fixed Assets Fund (Capitalised portion of Project Grants)
for the year ended 31st March 2012

Amount in Rs.

Previous year	P No	Particulars	Current Year
		virus type I long terminal repeat (HIV-ILTP)	235593.00
1012807.00	P-70	Identification of disease causing mutations in familial hypertrophic cardiomyopathy (FHC) patients from Andhra Pradesh	1012807.00
1573795.00	P-71	Referral Centre for Genetic fidelity testing of tissue culture raised plants	1573795.00
45653.00	P-72	Nuances of Non coding DNA near insulin-responsive genes	45653.00
1000000.00	P-74	Molecular basic of insect plant interactions in rice under the national fund for basic and strategic research in agriculture	1000000.00
33672.00	P-75	Preparing blueprint for the macromolecular crystallography beamline at Indus-II synchrotron source	33672.00
245266.00	P-76	A study of Molecular Markers in childhood Autism with special references to nuclear factors - APPA B"	245266.00
1543605.00	P-77	Functional characterization of Mycobacterium tuberculosis PE/PPE proteins having SH3 binding domain: Understanding their role in modulating macrophage functions	1543605.00
496826.00	P-79	Understanding the role of AGE proteins in inducing inflammatory responses and its regulation	496826.00
4192480.00	P-80	Referral Centre for Detection of Genetically Modified Foods employing DNA - based Markets	4192480.00
195728.00	P-81A	Financial Assistance for award of JC Bose Fellowship to Dr J Gowrishankar	195728.00
1387806.00	P-82	Functional Genomic Analysis of Candida Glabrata-macrophage	1441427.00
912255.00	P-83	Prokaryotic Transcription Termination Factor, Rho: Mechanism of Action and Biology	912255.00
388583.00	P-83A	Understanding the mechanism of Azadirachtin-mediated cell signaling: role in anti-inflammation and anti-tumorigenesis	388583.00
44854.00	P-84	Preparing for tuberculosis vaccine efficacy trials: Baseline epidemiology, improved diagnosis, markers of protection and phase I/II trials	44854.00
1256286.00	P-84A	Human epigenetic to the rescue of Human Identification process: Enriching human DNA from DNA mixture employing antibodies directed against 5-methylcytosine followed by whole genome amplification	1430573.00
374630.00	P-89	Characterization of Mycobacterium tuberculosis transcription machinery and Bacteriophage metagenomics	374630.00
1054715.00	P-90	Role of Yapsins in the Pathobiology of Candida Glabrata	1376869.00
932151.00	P-91	DNMT3L: Epigenetic correlation with cancer	932151.00
8128158.00	P-92	Swarnajayanti Fellowship: Designing transcription anti-terminators: a novel approach for making new inhibitors of gene expression	8500000.00
2389387.00	P - 93	Virtual Centre of Excellence on multidisciplinary approaches aimed at interventions against tuberculosis	2508568.00
246320.00	P - 95	Construction of regulatory networks in prokaryotes through protein: Protein interaction predictions and transcription regulation predictions.	246320.00
597647.00	P- 97	Proteome-wide Analysis of Serine pyrophosphorylation by inositol pyrophosphates	918196.00
2624610.00	P- 98	Role of cell - cell signaling mediated by Diffusible signaling factor (DSF) in Xanthomonas virulence	2783795.00
2272340.00	P- 99	Role of inositol Pyrophosphates in eukaryotic cell growth, proliferation and ribosome biogenesis	2921729.00
17784.00	P - 100	Effect of reactive oxygen species on T-Cell immune response: An approach to understand the molecular mechanism of immunosuppression during tuberculosis" - National Bioscience Award	17784.00
3391337.00	P-101	Role of inositol pyrophosphates in cell physiology: Investigating the biochemical significance of protein pyrophosphorylation - Senior Fellowship	6276263.00
658171.00	P-102	Understanding the role of Mycobacterium tuberculosis heat shockprotein 60 as Th1/Th2 immuno modular	681121.00
529925.00	P-107	IYBA Project - Mechanism and role of bacterial cell-cell signaling molecules in plant defense response	1000000.00
0.00	P-109	Molecular dissection of PI3-Kinase/Akt pathway by using proteomics based approach: A study to identify novel potential oncogenes and tumor suppressors	915278.00
0.00	P - 113	Clinical and molecular genetic analysis of squamous cell carcinoma of the tongue	268914.00
0.00	P-114	Evaluating the Calcineurin-NFAT Pathway and its regulators superoxide dismutase (SOD) AND RCAN1 (regular of Calcineurin) Down Syndrome	294008.00
0.00	P-115	Setting up of the National Institute of Animal Biotechnology	4580214.00
0.00	P-116	DBT-India and AIST - Japan : Understanding molecular mechanisms controlling dual role of Ras, Sirtuins and CARF in relation to cellular proliferation and senescence: Novel Strategy for developing cancer therapeutics	800000.00
0.00	P-118	Construction of regulatory networks in Mycobacterium tuberculosis through analysis of gene expression data and transcription regulation predictions. (MOU with Russian Foundation)	183443.00
0.00	P-122	Understanding the role of Hox genes in anterior-posterior axis determination of the central nervous system	438084.00
0.00	P-123	Establishment and Implementation of the Indo-German DST -MPG (Max Planck Society) Partner Group on Genetic Diversity Studies	101800.00
268914.00	P-127	Systematic studies on the functional network of phosphatases in cell life and death	2225907.00
11713327.00	COE-I	COE for Genetics and Genomics of silkworms	11713327.00
10000000.00	COE-II	DBT Centre of Excellence for Microbial Biology	10000000.00
239766747.00		Total	254856786.00

CENTRE FOR DNA FINGERPRINTING AND DIAGNOSTICS FOR THE YEAR ENDED 31st MARCH 2012		
Annexure: A Forming part of Receipts & Payment a/c		
Previous Year Amount Rs.	Particulars	Current Year Amount Rs.
	I-Remittances	
342116.00	GSLI	225224.00
3545182.00	Income tax	5678791.00
892851.00	LIC	1102504.00
440959.00	Professional tax	546897.00
371342.00	Works Tax	14920.00
211659.00	Service Tax	166864.00
781320.00	PPF	1574630.00
6585429.00		9309830.00

CENTRE FOR DNA FINGERPRINTING AND DIAGNOSTICS FOR THE YEAR ENDED 31st MARCH 2012		
Annexure: B Forming part of Receipts & Payment a/c		
Previous Year Amount Rs.	Particulars	Current Year Amount Rs.
	T.D.S.Recoveries	
380647.00	TDS on professional service	753967.00
1544357.00	TDS on Rent	2532661.00
872899.00	TDS on works / Contractors	1454181.00
6386.00	TDS on Deposits	0.00
2804289.00		4740809.00

**CENTRE FOR DNA FINGERPRINTING AND DIAGNOSTICS
FOR THE YEAR ENDED 31st MARCH 2012**

Annexure: C Forming part of Receipts & Payment a/c

Previous Year Amount Rs.	Particulars	Current Year Amount Rs.
	Advance refunds/recovery/Adjst.	
733288.00	Advances for Consumables	14201834.00
29703699.00	Advances for Equipment	107532410.00
202181.00	Advances to staff for L.P	443063.00
0.00	Deposits - Customs duty	14429932.00
23092222.00	EMD / Margin money	310300.00
92400.00	Festival Advances recovery	118725.00
16267.00	H B A	0.00
204000.00	HSD, LSD & TSD	217360.00
1311816.00	LTC Advances	335803.00
73100.00	Other Advances	157634.00
154519.00	Revolving Advances	301909.00
3682761.00	TA/DAAvances	4513584.00
37728.00	Vehicle / Conveyance advance	37500.00
249080.00	Royalties & Consultancy	233890.00
50000.00	Security Deposit / Retension Money	533750.00
24200.00	Computer Advance - staff	41200.00
0.00	Rent advance	0.00
40838.00	Computer Advance - Research Fellows	201249.00
0.00	NIMS-Advance	582180.00
0.00	CDFD Staff Reserve Fund	2644290.00
59668099.00		146836613.00

**CENTRE FOR DNA FINGERPRINTING AND DIAGNOSTICS
FOR THE YEAR ENDED 31st MARCH 2012**

Annexure: D Forming part of Receipts & Payment a/c

Previous Year Amount Rs.	Particulars	Current Year Amount Rs.
	Projects - Receipts	
9566000.00	P - 65A	5103400.00
159363.00	P - 69	0.00
1808000.00	P - 71	1020000.00
751300.00	P- 79	1795900.00
951800.00	P- 81	0.00
1455000.00	P- 81A	1300000.00
596000.00	P- 82	839000.00
714000.00	P- 84A	0.00
1480000.00	P - 88	0.00
300000.00	P - 89	300000.00
0.00	P - 90	618700.00
3132400.00	P - 92	3500000.00
657000.00	P - 93	2010000.00
700000.00	P - 95	0.00
1251970.00	P - 96	1452712.00
835000.00	P - 97	532000.00
290000.00	P - 98	1641200.00
0.00	P - 99	726299.00
6784587.00	P - 101	4470916.00
1181319.00	P - 102	1086164.00
300000.00	P - 103	0.00
1437000.00	P - 104	0.00
827000.00	P - 105	681000.00
238302.00	P - 106	1602302.00
2027000.00	P - 107	773000.00
487000.00	P - 108	470400.00
2027000.00	P - 109	742000.00
170000.00	P - 110	0.00
1400000.00	P - 111	1511500.00
1460000.00	P - 112	1000000.00
1139487.00	P - 113	848689.00
2070000.00	P - 114	0.00
5000000.00	P - 115	65500000.00
2037200.00	P - 116	0.00
5593000.00	P - 117	0.00
1400770.00	P - 118	0.00
800000.00	P - 119	0.00
827000.00	P - 120	0.00
345776.00	P - 121	0.00
0.00	P - 122	13606258.00
0.00	P - 123	2884810.00
0.00	P - 124	819000.00
0.00	P - 125	764000.00
0.00	P - 126	2539300.00
0.00	P - 127	11097596.00
0.00	P - 128	2807200.00

**CENTRE FOR DNA FINGERPRINTING AND DIAGNOSTICS
FOR THE YEAR ENDED 31st MARCH 2012**

Annexure: D Forming part of Receipts & Payment a/c

Previous Year Amount	Rs.	Particulars	Current Year Amount	Rs.
		Projects - Receipts		
	0.00	P - 129		306000.00
	0.00	P - 130		5987000.00
	0.00	P - 131		1899200.00
	0.00	P - 132		929200.00
	0.00	P - 133		1849000.00
	0.00	P - 134		400000.00
	0.00	P - 135		7943200.00
	0.00	P - 136		837200.00
	0.00	P - 137		1500000.00
	0.00	P - 139		2467200.00
	0.00	P - 144		267184.00
	8913000.00	COE- I		22433000.00
	13680000.00	COE- II		8570000.00
	84793274.00			189431530.00

**CENTRE FOR DNA FINGERPRINTING AND DIAGNOSTICS
FOR THE YEAR ENDED 31st MARCH 2012**

Annexure: E Forming part of Receipts & Payment a/c

Previous Year Amount Rs.	Particulars	Current Year Amount Rs.
	Advances	
394883.00	Advance to staff for Local purchases	264000.00
9093263.00	Advances for Consumables	13039405.00
22723544.00	Advances for Equipment	28472236.00
3011292.00	Deposits for Custom duty etc.,	9667900.00
20538000.00	EMD / Margin money	2178922.00
99000.00	Festival advances paid	131250.00
79000.00	LSD , HSD & TSD	140000.00
928731.00	LTC Advance	1118680.00
181729.00	Other Advances	376415.00
182500.00	Revolving Advance	223500.00
3659524.00	TA/ DA Advance	3785265.00
0.00	Royalties & Consultancy	1239852.00
410000.00	Security Deposit / Retension Money	9750.00
245000.00	Computer Advance - Research Fellows	35000.00
0.00	Computer Advance - Staff	30000.00
0.00	NIMS Advance	916289.00
0.00	Rent Advance	64000.00
0.00	Vehicle Advance	60000.00
0.00	Indo Canada Workshop	538860.00
61546466.00		62291324.00

CENTRE FOR DNA FINGERPRINTING AND DIAGNOSTICS FOR THE YEAR ENDED 31st MARCH 2012		
Annexure: F Forming part of Receipts & Payment a/c		
Previous Year Amount Rs.	Particulars	Current Year Amount Rs.
	I-Remittances paid	
402196.00	GSLI	210600.00
3559943.00	Income tax	5622209.00
892851.00	LIC	1099954.00
441639.00	Professional tax	544966.00
318037.00	Works Tax	26093.00
211659.00	Service Tax	166864.00
768160.00	PPF	1570900.00
6594485.00		9241586.00

CENTRE FOR DNA FINGERPRINTING AND DIAGNOSTICS FOR THE YEAR ENDED 31st MARCH 2012		
Annexure: G Forming part of Receipts & Payment a/c		
Previous Year Amount Rs.	Particulars	Current Year Amount Rs.
	TDS remitted in Central Govt. a/c	
327736.00	TDS on professional service	862005.00
1539198.00	TDS on Rent	2412648.00
835074.00	TDS on works / Contractors	1434409.00
6386.00	TDS on deposits	0.00
2708394.00		4709062.00

**CENTRE FOR DNA FINGERPRINTING AND DIAGNOSTICS
FOR THE YEAR ENDED 31st MARCH 2012**

Annexure: H Forming part of Receipts & Payment a/c

Previous Year Amount Rs.	Particulars	Current Year Amount Rs.
	Projects - Expenditure	
79206.00	P - 30	0.00
80930.00	P - 31	0.00
17821.00	P - 42	0.00
68142.00	P - 43	0.00
18356.00	P - 45	0.00
0.00	P - 49A	29363.00
661793.00	P - 65A	2547094.00
784241.00	P - 71	412681.00
2194.00	P - 77	0.00
16258.00	P - 79	0.00
25523.00	P - 80	554228.00
152737.00	P - 81	70745.00
1347200.00	P - 81A	1345180.00
848007.00	P - 82	1106732.00
62560.00	P - 83	0.00
40065.00	P - 83A	0.00
693319.00	P - 84A	783120.00
185254.00	P - 85	0.00
78291.00	P - 86	0.00
1022465.00	P - 88	740000.00
300000.00	P - 89	0.00
825212.00	P - 90	802987.00
961218.00	P - 91	311836.00
4297631.00	P - 92	3521916.00
2159039.00	P - 93	2832707.00
154490.00	P - 95	424041.00
720897.00	P - 96	796770.00
929176.00	P - 97	1118988.00
1569461.00	P - 98	1237665.00
1777257.00	P - 99	1874442.00
300000.00	P - 100	35000.00
6384457.00	P - 101	6430446.00
1142771.00	P - 102	558377.00
300000.00	P - 103	300000.00

**CENTRE FOR DNA FINGERPRINTING AND DIAGNOSTICS
FOR THE YEAR ENDED 31st MARCH 2012**

Annexure: H Forming part of Receipts & Payment a/c

Previous Year Amount Rs.	Particulars	Current Year Amount Rs.
	Projects - Expenditure	
1139387.00	P - 104	1692479.00
681029.00	P - 105	917815.00
684358.00	P - 106	965294.00
1424994.00	P - 107	1311406.00
302977.00	P - 108	584498.00
550896.00	P - 109	1902478.00
145611.00	P - 110	193068.00
911369.00	P - 111	1568400.00
656274.00	P - 112	1803726.00
588772.00	P - 113	864774.00
537239.00	P - 114	1481208.00
440695.00	P - 115	62019564.00
344383.00	P - 116	1981237.00
341500.00	P - 117	5251500.00
285000.00	P - 118	1115770.00
239658.00	P - 119	1298947.00
210000.00	P - 120	492400.00
308680.00	P - 121	634282.00
0.00	P - 122	2127215.00
0.00	P - 123	810754.00
0.00	P - 124	651716.00
0.00	P - 125	610000.00
0.00	P - 126	957685.00
0.00	P - 127	6044881.00
0.00	P - 128	753613.00
0.00	P - 130	1800000.00
0.00	P - 131	716265.00
0.00	P - 132	294877.00
0.00	P - 133	300000.00
0.00	P - 134	146000.00
0.00	P - 135	525000.00
37209825.00	COE - I	12344655.00
12049954.00	COE - II	12948013.00
87058572.00		154943838.00

**CENTRE FOR DNA FINGERPRINTING AND DIAGNOSTICS
FOR THE YEAR ENDED 31st MARCH 2012**

Annexure: I Forming part of Balance Sheet

Previous Year Amount Rs.	Particulars	Current Year Amount Rs.
	CDFD C.P. FUND ACCOUNT	
27346637.32	Opening Balance	33724337.32
	Add:	
6786724.00	Employees subscription / refunds	7891447.00
769851.00	Transfer from other departments	62280.00
3123315.00	Institute contribution (incl. Projects staff)	3323326.00
68411.00	Interest received	85173.00
38094938.32		45086563.32
4370601.00	Less:Advances/withdrawals/Transfer/ Adjst	15927187.00
33724337.32		29159376.32

**CENTRE FOR DNA FINGERPRINTING AND DIAGNOSTICS
FOR THE YEAR ENDED 31st MARCH 2012**

Annexure: J Forming part of Balance sheet

Previous Year Amount Rs.	Particulars	Current Year Amount Rs.
	LOANS AND ADVANCES	
70828689.00	Advances for Consumables	69666260.00
147138287.45	Advances for Equipment	68078113.45
427282.50	Advances to staff for L.P	248219.50
25512.00	DBT PDF (Stipend receivable)	25512.00
65400.00	Festival Advance	77925.00
4310.00	G.S.L.I Recovery	4310.00
907246.00	Grant receivable - Host meetings	907246.00
199287.00	LTC Advance	982164.00
5040103.00	Other Advances	5258884.00
240569.00	Rent advance	304569.00
161646.00	Revolving Advances	83237.00
611994.56	TA/DA Advance & Recoupments	0.00
3000000.00	CDFD Staff Reserve Fund	355710.00
1396829.00	DBT JRF A/c (Stipend receivable)	1158629.00
4866183.00	EMRC A/c (Stipend receivable)	10618518.00
383904.00	ICMR A/c (Stipend receivable)	1597907.00
681501.00	Indo - Japan Workshop	681501.00
10000000.00	NIMS - Advance	10334109.00
72.00	Service Tax	72.00
2058481.00	UGC (Stipend receivable)	0.00
394494.00	Advance for workshop	394494.00
204162.00	Computer advance - Research Fellows	37913.00
9350.00	CPF Advance Recovery	0.00
17109.00	DST Inspire	13748.00
417047.00	Transcription Assembly Meeting	417047.00
249079458.51		171246087.95

CENTRE FOR DNA FINGERPRINTING AND DIAGNOSTICS FOR THE YEAR ENDED 31st MARCH 2012		
Annexure: K Forming part of Balance sheet		
Previous Year Amount Rs.	Particulars	Current Year Amount Rs.
	DEPOSITS	
4317957.00	A.P.Transco	4985857.00
14713171.00	Balmer Lawrie - Customs duty	3295239.00
35900.00	Gas agencies	35900.00
15000.00	Internet	15000.00
185000.00	Telephones	185000.00
47680.00	APSRTC	47680.00
12000.00	University Filling Station	0.00
0.00	Vimta Labs	6000000.00
18699.00	Others	18699.00
19345407.00		14583375.00

CENTRE FOR DNA FINGERPRINTING AND DIAGNOSTICS FOR THE YEAR ENDED 31st MARCH 2012		
Annexure: L Forming part of Balance sheet		
Previous Year Amount Rs.	Particulars	Current Year Amount Rs.
	INVESTMENT A/C	
12270000.00	Internal resources / Core	0.00
54738000.00	Project Funds	51098273.00
10600000.00	Collaboration Funds	10600000.00
700000.00	Workshop funds	700000.00
78308000.00		62398273.00

**CENTRE FOR DNA FINGERPRINTING AND DIAGNOSTICS
FOR THE YEAR ENDED 31st MARCH 2012**

Annexure: M Forming part of Balance sheet

Previous Year Amount Rs.	Particulars	Current Year Amount Rs.
	CDFD C.P.FUND INVESTMENT A/C	
660170.00	60229.549 Units of UTI BOND FUND	660170.00
276190.00	21616.5080 Units of UTI BOND FUND	276190.00
28702519.00	Fixed deposits	23202519.00
4085458.32	CDFD C.P.FUND a/c	5020497.32
27346637.32		29159376.32

CENTRE FOR DNA FINGERPRINTING AND DIAGNOSTICS, HYDERABAD					
P - 03 : D.B.T Project on "TRANSGENESIS & GENETIC BASIS OF PATHOGEN RESISTANCE IN THE SILKWORM, <i>Bombyx mori</i> "					
P.I. Dr J NAGARAJU					
RECEIPTS AND PAYMENTS ACCOUNT FROM 01.04.2011 TO 31.03.2012					
Previous Year Amount Rs	Receipts	Current Year Amount Rs.	Previous Year Amount Rs	Payments	Current Year Amount Rs
0.00	Opening Balance	0.00	630047.00	Opening Balance	630047.00
0.00	Grant in aid	0.00		Equipment	0.00
				Salaries - Manpower	0.00
				Consumables	0.00
				Travel	0.00
				Contingencies	0.00
0.00		0.00	630047.00		630047.00
630047.00	Excess of expenditure over income	630047.00	630047.00		630047.00
630047.00		630047.00	630047.00		630047.00

CENTRE FOR DNA FINGERPRINTING AND DIAGNOSTICS, HYDERABAD					
P - 09 - "CSIR, NIMITLI Project on - LATENT <i>M. TUBERCULOSIS</i> : NEW TARGETS, DRUG DELIVERY SYSTEMS, BIO-ENHANCERS & THERAPEUTICS"					
P.I. Dr Seyed E Hasnain					
RECEIPTS AND PAYMENTS ACCOUNT FROM 01.04.2011 TO 31.03.2012					
Previous Year Amount Rs	Receipts	Current Year Amount Rs.	Previous Year Amount Rs	Payments	Current Year Amount Rs
244305.00	Opening Balance	244305.00	0.00	Salaries- Manpower	0.00
0.00	Grant in aid	0.00	0.00	Consumables	0.00
			0.00	Contingencies	0.00
			0.00	Travel	0.00
			0.00	Overheads	0.00
			0.00	Equipment	0.00
244305.00		244305.00	0.00		0.00
			244305.00	Closing Balance	244305.00
244305.00		244305.00	244305.00		244305.00

CENTRE FOR DNA FINGERPRINTING AND DIAGNOSTICS, HYDERABAD					
P-10 : DST Project on "ROLE OF UPSTREAM SEQUENCE ELEMENTS IN HYPERACTIVATION OF TRANSCRIPTION FROM BACULOVIRUS POLYHEDRIN GENE PROMOTER"					
P.I . Dr M D BASHYAM					
RECEIPTS AND PAYMENTS ACCOUNT FROM 01.04.2011 TO 31.03.2012					
Previous Year Amount Rs	Receipts	Current Year Amount Rs.	Previous Year. Amount Rs	Payments	Current Year Amount Rs
0.00	Opening Balance	0.00	28332.00	Opening Balance	28332.00
0.00	Grant in aid	0.00	0.00	Consumables	0.00
			0.00	Contingencies	0.00
			0.00	Travel	0.00
			0.00	Overheads	0.00
			0.00	Equipment	0.00
0.00		0.00	28332.00		28332.00
28332.00	Excess of expenditure over income	28332.00			
28332.00		28332.00	28332.00		28332.00

CENTRE FOR DNA FINGERPRINTING AND DIAGNOSTICS, HYDERABAD					
P-13 : DBT Project on "PROGRAMME TO DELINEATE GENE FUNCTIONS IN THE POST - GENOMICS ERA BY A SYSTEMATIC TWO GENE KNOCKOUT METHOD"					
P.I . Dr J GOWRISHANKAR					
RECEIPTS AND PAYMENTS ACCOUNT FROM 01.04.2011 TO 31.03.2012					
Previous Year Amount Rs	Receipts	Current Year Amount Rs.	Previous Year. Amount Rs	Payments	Current Year Amount Rs
6737.00	Opening Balance	6737.00	0.00	Salaries- Manpower	0.00
0.00	Grant in aid	0.00	0.00	Consumables	0.00
			0.00	Contingencies	0.00
			0.00	Travel	0.00
			0.00	Overheads	0.00
			0.00	Equipment	0.00
6737.00		6737.00	6737.00	Closing balance	6737.00
6737.00		6737.00	6737.00		6737.00

CENTRE FOR DNA FINGERPRINTING AND DIAGNOSTICS, HYDERABAD					
P-17 : DST Project on "STUDIES ON INOSITAL - PHOSPHATE SYNTHESIS - A NOVEL ENZYME FROM MYCOBACTERIUM TUBERCULOSIS - H37RV"					
P.I. Dr SHEKHAR C MANDE					
RECEIPTS AND PAYMENTS ACCOUNT FROM 01.04.2011 TO 31.03.2012					
Previous Year Amount Rs	Receipts	Current Year Amount Rs.	Previous Year. Amount Rs	Payments	Current Year Amount Rs
0.00	Opening Balance	0.00	687887.00	Opening Balance	687887.00
0.00	Grant in aid	0.00	0.00	Salaries - Manpower	0.00
				Consumables	0.00
				Contingencies	0.00
				Travel	0.00
				Over heads	0.00
				Equipment	0.00
0.00		0.00	687887.00		687887.00
687887.00	Excess of expenditure over income	687887.00			
687887.00		687887.00	687887.00		687887.00

CENTRE FOR DNA FINGERPRINTING AND DIAGNOSTICS, HYDERABAD					
P-18 : DST Project on "MAPPING OF RECEPTOR BINDING SITE ON THE EYTHROCYTE BINDING OF MALARIA PARASITE"					
P.I. Dr AKASH RANJAN					
RECEIPTS AND PAYMENTS ACCOUNT FROM 01.04.2011 TO 31.03.2012					
Previous Year Amount Rs	Receipts	Current Year Amount Rs.	Previous Year. Amount Rs	Payments	Current Year Amount Rs
0.00	Opening Balance	0.00	274286.00	Opening balance	274286.00
0.00	Grant in aid	0.00	0.00	Consumables	0.00
				Contingencies	0.00
				Travel	0.00
				Overheads	0.00
				Equipment	0.00
0.00		0.00	274286.00		274286.00
274286.00	Excess of expenditure over income	274286.00			
274286.00		274286.00	274286.00		274286.00

CENTRE FOR DNA FINGERPRINTING AND DIAGNOSTICS, HYDERABAD P - 20 : DBT Project on "GENOMIC MICRO ARRAY R&D PROGRAMMES ON INFECTIOUS DISEASES AND NEUROLOGICAL DISORDERS" PI: Dr M D BASHYAM RECEIPTS AND PAYMENTS ACCOUNT FROM 01.04.2011 TO 31.03.2012					
Previous Year Amount Rs	Receipts	Current Year Amount Rs.	Previous Year. Amount Rs	Payments	Current Year Amount Rs
0.00	Opening Balance	0.00	1888111.00	Opening balance	1888111.00
0.00	Grant in aid	0.00	0.00	Salaries - Manpower	0.00
			0.00	Consumables	0.00
			0.00	Contingencies	0.00
			0.00	Travel	0.00
			0.00	Overheads	0.00
			0.00	Equipment	0.00
0.00		0.00	1888111.00		1888111.00
1888111.00	Excess of expenditure over income	1888111.00	0.00	Closing balance	0.00
1888111.00		1888111.00	1888111.00		1888111.00

CENTRE FOR DNA FINGERPRINTING AND DIAGNOSTICS, HYDERABAD P-23: DBT Project on "DEVELOPMENT OF PCR BASE ASSAYS FOR DETECTION OF GMO'S" PI . Dr J NAGARAJU RECEIPTS AND PAYMENTS ACCOUNT FROM 01.04.2011 TO 31.03.2012					
Previous Year Amount Rs	Receipts	Current Year Amount Rs.	Previous Year. Amount Rs	Payments	Current Year Amount Rs
0.00	Opening Balance	0.00	34495.00	Opening balance	34495.00
0.00	Grant in aid	0.00	0.00	Salaries- Manpower	0.00
			0.00	Consumables	0.00
			0.00	Contingencies	0.00
			0.00	Travel	0.00
			0.00	Overheads	0.00
			0.00	Equipment	0.00
0.00		0.00	34495.00		34495.00
34495.00	Excess of expenditure over income	34495.00	0.00	Closing balance	0.00
34495.00		34495.00	34495.00		34495.00

CENTRE FOR DNA FINGERPRINTING AND DIAGNOSTICS, HYDERABAD P-25 : DBT Project on "FUNCTIONAL STUDIES OF HUMAN IMMUNO DEFICIENCY VIRUS TYPE-2(HIV-2), VIRAL PROTEIN X(VPX)" PI . Dr S MAHALINGAM RECEIPTS AND PAYMENTS ACCOUNT FROM 01.04.2011 TO 31.03.2012					
Previous Year Amount Rs	Receipts	Current Year Amount Rs.	Previous Year Amount Rs	Payments	Current Year Amount Rs
0.00	Opening Balance Grant in aid	0.00	529111.00	Opening balance	529111.00
0.00		0.00	0.00	Salaries- Manpower	0.00
				Consumables	0.00
				Contingencies	0.00
				Travel	0.00
				Overheads	0.00
				Equipment	0.00
0.00		0.00	529111.00		529111.00
529111.00	Excess of expenditure over income	529111.00			
529111.00		529111.00	529111.00		529111.00

CENTRE FOR DNA FINGERPRINTING AND DIAGNOSTICS, HYDERABAD P-26 : IFCPAR Project on "OCCURRENCE OF MUTATIONS IN NON-DIVIDING CELLS OF ESCHERICHIA COLI" PI . Dr J GOWRISHANKAR RECEIPTS AND PAYMENTS ACCOUNT FROM 01.04.2011 TO 31.03.2012					
Previous Year Amount Rs	Receipts	Current Year Amount Rs.	Previous Year Amount Rs	Payments	Current Year Amount Rs
0.00	Opening Balance Grant in aid	0.00	79533.00	Opening balance	79533.00
0.00		0.00	0.00	Salaries - Manpower	0.00
				Consumables	0.00
				Contingencies	0.00
				Travel	0.00
				Overheads	0.00
				Equipment	0.00
0.00		0.00	79533.00		79533.00
79533.00	Excess of expenditure over income	79533.00			
79533.00		79533.00	79533.00		79533.00

CENTRE FOR DNA FINGERPRINTING AND DIAGNOSTICS, HYDERABAD P-28 : IFCPAR Project on "BACULOVIRUS - RESISTANCE IN TRANSGENIC SILKWORMS" P.I. Dr J NAGARAJU RECEIPTS AND PAYMENTS ACCOUNT FROM 01.04.2011 TO 31.03.2012					
Previous Year Amount Rs	Receipts	Current Year Amount Rs.	Previous Year Amount Rs	Payments	Current Year Amount Rs
0.00	Opening Balance	0.00	37624.00	Opening balance	37624.00
0.00	Grant in aid	0.00	0.00	Salaries - Manpower	0.00
			0.00	Consumables	0.00
			0.00	Contingencies	0.00
			0.00	Travel	0.00
			0.00	Overheads	0.00
			0.00	Equipment	0.00
0.00		0.00	37624.00		37624.00
37624.00	Excess of expenditure over income	37624.00			
37624.00		37624.00	37624.00		37624.00

CENTRE FOR DNA FINGERPRINTING AND DIAGNOSTICS, HYDERABAD P-29 : DST Project on "DEVELOPMENT OF HOSPITAL INFECTION SURVEILLANCE SYSTEM BY ADVANCED DIAGNOSTICS METHOD & Molecular DNA fingerprinting techniques" P.I. Dr K PRASHANTH RECEIPTS AND PAYMENTS ACCOUNT FROM 01.04.2011 TO 31.03.2012					
Previous Year Amount Rs	Receipts	Current Year Amount Rs.	Previous Year Amount Rs	Payments	Current Year Amount Rs
0.00	Opening Balance	0.00	310302.00	Opening balance	310302.00
0.00	Grant in aid	0.00	0.00	Salaries - Manpower	0.00
			0.00	Consumables	0.00
			0.00	Contingencies	0.00
			0.00	Travel	0.00
			0.00	Overheads	0.00
			0.00	Equipment	0.00
0.00		0.00	310302.00		310302.00
310302.00	Excess of expenditure over income	310302.00			
310302.00		310302.00	310302.00		310302.00

CENTRE FOR DNA FINGERPRINTING AND DIAGNOSTICS, HYDERABAD P-30 : NIH Project on "TRANSCRIPTION TERMINATION AND ANTI TERMINATION IN E. COLI" P.I. Dr RANJAN SEN RECEIPTS AND PAYMENTS ACCOUNT FROM 01.04.2011 TO 31.03.2012					
Previous Year Amount Rs	Receipts	Current Year Amount Rs.	Previous Year Amount	Payments	Current Year
2124902.00	Opening Balance	2045696.00	79206.00	Salaries- Manpower	0.00
0.00	Grant in aid	0.00	0.00	Consumables	0.00
			0.00	Contingencies	0.00
			0.00	Travel	0.00
			0.00	Overheads	0.00
			0.00	Equipment	0.00
2124902.00		2045696.00	79206.00		0.00
			2045696.00	Closing balance	2045696.00
2124902.00		2045696.00	2124902.00		2045696.00

CENTRE FOR DNA FINGERPRINTING AND DIAGNOSTICS, HYDERABAD P-31 : NIH Project on "FUNCTIONING OF K-RAS IN LUNG TYPE II EPITHELIAL CELLS" P.I. Dr GAYATRI RAMAKRISHNA RECEIPTS AND PAYMENTS ACCOUNT FROM 01.04.2011 TO 31.03.2012					
Previous Year Amount Rs	Receipts	Current Year Amount Rs.	Previous Year Amount Rs	Payments	Current Year Amount Rs
827383.00	Opening Balance	746543.00	80930.00	Salaries - Manpower	0.00
0.00	Grant in aid	0.00	0.00	Consumables	0.00
			0.00	Contingencies	0.00
			0.00	Travel	0.00
			0.00	Overheads	0.00
			0.00	Equipment	0.00
827383.00		746543.00	80930.00		0.00
			746453.00.00	Closing balance	746543.00
827383.00		746543.00	827383.00		746543.00

P-33: DBT Project on "MOLECULAR AND EPIDEMIOLOGICAL CHARACTERISATION OF CRYPTOSPORIDIUM - AN ENTERIC PROTOZOON PARASITE" CENTRE FOR DNA FINGERPRINTING AND DIAGNOSTICS, HYDERABAD P.I. Dr A RADHA RAMA DEVI RECEIPTS AND PAYMENTS ACCOUNT FROM 01.04.2011 TO 31.03.2012					
Previous Year Amount Rs	Receipts	Current Year Amount Rs.	Previous Year Amount Rs	Payments	Current Year Amount Rs
0.00	Opening Balance	0.00	234000.00	Opening balance	234000.00
0.00	Grant in aid	0.00		Salaries - Manpower	0.00
				Consumables	0.00
				Contingencies	0.00
				Travel	0.00
				Overheads	0.00
				Equipment	0.00
0.00		0.00	234000.00		
234000.00	Excess of expenditure over income	234000.00			
234000.00		234000.00	234000.00		234000.00

P-34 : DBT Project on "MOLECULAR ANALYSIS OF LEPIDOPTERAN - SPECIFIC IMMUNE PROTIENS FROM SILKMOTHS" CENTRE FOR DNA FINGERPRINTING AND DIAGNOSTICS, HYDERABAD P.I. Dr J NAGARAJU RECEIPTS AND PAYMENTS ACCOUNT FROM 01.04.2011 TO 31.03.2012					
Previous Year Amount Rs	Receipts	Current Year Amount Rs.	Previous Year Amount Rs	Payments	Current Year Amount Rs
26334.00	Opening Balance	26334.00	0.00	Salaries - Manpower	0.00
0.00	Grant in aid	0.00	0.00	Consumables	0.00
			0.00	Contingencies	0.00
			0.00	Travel	0.00
			0.00	Overheads	0.00
			0.00	Equipment	0.00
26334.00		26334.00	0.00		0.00
			26334.00	Closing balance	26334.00
26334.00		26334.00	26334.00		26334.00

CENTRE FOR DNA FINGERPRINTING AND DIAGNOSTICS, HYDERABAD P-35 : DST Project on "IDENTIFICATION, CHARACTERIZATION AND PHYSICAL MAPPING OF Z-CHROMOSOME LINKED GENES OF THE SILKWORM, BOMBYX MORI" PI. Dr J NAGARAJU RECEIPTS AND PAYMENTS ACCOUNT FROM 01.04.2011 TO 31.03.2012						
Previous Year Amount Rs	Receipts	Current Year Amount Rs.	Previous Year Amount Rs	Payments	Current Year Amount Rs	
0.00	Opening Balance	0.00	283883.00	Opening balance	283883.00	
0.00	Grant in aid	0.00		Salaries - Manpower	0.00	
				Consumables	0.00	
				Contingencies	0.00	
				Travel	0.00	
				Overheads	0.00	
				Equipment	0.00	
0.00		0.00	0.00		0.00	
283883.00	Excess of expenditure over income	283883.00				
283883.00		283883.00	283883.00		283883.00	

CENTRE FOR DNA FINGERPRINTING AND DIAGNOSTICS, HYDERABAD P-36 : DBT Multicentric project on "DEVELOPMENT OF ARTIFICIAL RETINA USING BACTERIORHODOSPIN AND GENETICALLY ENGINEERED ANALOGUES" AT CDFD & MRC PI. Dr SHEKAR C MANDE RECEIPTS AND PAYMENTS ACCOUNT FROM 01.04.2011 TO 31.03.2012						
Previous Year Amount Rs	Receipts	Current Year Amount Rs.	Previous Year Amount Rs	Payments	Current Year Amount Rs	
2073896.00	Opening Balance	2073896.00	0.00	Salaries - Manpower	0.00	
0.00	Grant in aid	0.00	0.00	Consumables	0.00	
			0.00	Contingencies	0.00	
			0.00	Travel	0.00	
			0.00	Overheads	0.00	
			0.00	Equipment	0.00	
2073896.00		2073896.00	0.00		0.00	
			2073896.00	Closing balance	2073896.00	
2073896.00		2073896.00	2073896.00		2073896.00	

CENTRE FOR DNA FINGERPRINTING AND DIAGNOSTICS, HYDERABAD P-40 : DST Project on "ANTIOXIDANTS AS A POTENTIAL IMMUNO-ADJUVANT IN ANTI-TUBERCULOSIS IMMUNOTHERAPY" P.I . Dr SANGITA MUKHOPADHYAY RECEIPTS AND PAYMENTS ACCOUNT FROM 01.04.2011 TO 31.03.2012									
Previous Year Amount	Rs	Receipts	Current Year Amount	Rs.	Previous Year Amount	Rs	Payments	Current Year Amount	Rs
0.00		Opening Balance		0.00	226058.00		Opening balance	226058.00	
0.00		Grant in aid		0.00			Salaries - Manpower	0.00	
							Consumables	0.00	
							Contingencies	0.00	
							Travel	0.00	
							Overheads	0.00	
							Equipment	0.00	
0.00				0.00	226058.00			226058.00	
226058.00		Excess of expenditure over income		226058.00					
226058.00				226058.00				226058.00	

CENTRE FOR DNA FINGERPRINTING AND DIAGNOSTICS, HYDERABAD P-41 : DBT Project on "CONSTRUCTION AND CHARACTERIZATION AND ANALYSIS OF EXPRESSED SEQUENCES FROM SILKWORM" P.I . Dr J NAGARAJU RECEIPTS AND PAYMENTS ACCOUNT FROM 01.04.2011 TO 31.03.2012									
Previous Year Amount	Rs	Receipts	Current Year Amount	Rs.	Previous Year Amount	Rs	Payments	Current Year Amount	Rs
1873605.00		Opening Balance		1873605.00	0.00		Opening balance	0.00	
0.00		Grant in aid		0.00			Salaries - Manpower	0.00	
							Consumables	0.00	
							Contingencies	0.00	
							Travel	0.00	
							Overheads	0.00	
							Equipment	0.00	
1873605.00				1873605.00	0.00			0.00	
0.00		Excess of expenditure over income		0.00	1873605.00		Closing balance	1873605.00	
1873605.00				1873605.00				1873605.00	

<p align="center">CENTRE FOR DNA FINGERPRINTING AND DIAGNOSTICS, HYDERABAD P-42 : The Wellcome Trust, UK Project on "STRUCTURAL AND FUNCTIONAL STUDIES ON MYCOBACTERIUM TUBERCULOSIS HEAT SHOCK PROTEINS" P.I. Dr SHEKAR C MANDE RECEIPTS AND PAYMENTS ACCOUNT FROM 01.04.2011 TO 31.03.2012</p>						
Previous Year Amount Rs	Receipts	Current Year Amount Rs.	Previous Year Amount Rs	Payments	Current Year Amount Rs	
0.00	Opening Balance	0.00	2219464.00	Opening balance	2237285.00	
0.00	Grant in aid	0.00	17821.00	Salaries- Manpower	0.00	
			0.00	Consumables	0.00	
			0.00	Contingencies	0.00	
			0.00	Travel	0.00	
			0.00	Overheads	0.00	
			0.00	Equipment	0.00	
			0.00	Funds transferred to P-84	0.00	
0.00		0.00	2237285.00		2237285.00	
2237285.00	Excess of expenditure over income	2237285.00	0.00	Closing balance	0.00	
2237285.00		2237285.00	2237285.00		2237285.00	

<p align="center">CENTRE FOR DNA FINGERPRINTING AND DIAGNOSTICS, HYDERABAD P-43 : The Wellcome Trust, UK Project on "A GENERALISED MECHANISM OF TRANSCRIPTION TERMINATION IN PROKARYOTES: A QUEST FOR MECHANISM BASED TRANSCRIPTION INHIBITORS FOR MICROBIAL PATHOGENS" P.I. Dr RANJAN SEN RECEIPTS AND PAYMENTS ACCOUNT FROM 01.04.2011 TO 31.03.2012</p>						
Previous Year Amount Rs	Receipts	Current Year Amount Rs.	Previous Year Amount Rs	Payments	Current Year Amount Rs	
754048.70	Opening Balance	685906.70	68142.00	Salaries- Manpower	0.00	
0.00	Grant in aid	0.00	0.00	Consumables	0.00	
			0.00	Contingencies	0.00	
			0.00	Travel	0.00	
			0.00	Overheads	0.00	
			0.00	Equipment	0.00	
754048.70		685906.70	68142.00		0.00	
			685906.70	Closing balance	685906.70	
754048.70		685906.70	754048.70		685906.70	

<p align="center">CENTRE FOR DNA FINGERPRINTING AND DIAGNOSTICS, HYDERABAD P-44 : DBT Project on "UNDERSTANDING THE ROLE OF RAS AND NO /INOS SIGNALLING IN PROMOTION OF HEPATOCELLULAR CARCINOMAS WITH PERSISTENT HBV INFECTION" P.I . Dr GAYATRI RAMAKRISHNA RECEIPTS AND PAYMENTS ACCOUNT FROM 01.04.2011 TO 31.03.2012</p>					
Previous Year Amount Rs	Receipts	Current Year Amount Rs.	Previous Year. Amount Rs	Payments	Current Year Amount Rs
0.00	Opening Balance Grant in aid	0.00	457538.00	Opening balance	457538.00
0.00		0.00	0.00	Salaries - Manpower	0.00
				Consumables	0.00
				Contingencies	0.00
				Travel	0.00
				Overheads	0.00
				Equipment	0.00
0.00	Excess of expenditure over income	0.00	457538.00		
457538.00			457538.00		
457538.00		457538.00	457538.00		457538.00

<p align="center">CENTRE FOR DNA FINGERPRINTING AND DIAGNOSTICS, HYDERABAD P-45 : The Wellcome Trust, UK Project on "SPECIALISED CHROMATIN STRUCTURES AS EPIGENETIC IMPRINTS TO DISTINGUISH PARENTAL ALLELES" P.I. Dr SANJEEV KHOSLA RECEIPTS AND PAYMENTS ACCOUNT FROM 01.04.2011 TO 31.03.2012</p>					
Previous Year Amount Rs	Receipts	Current Year Amount Rs.	Previous Year. Amount Rs	Payments	Current Year Amount Rs
624070.00	Opening Balance Grant in aid	605714.00	0.00	Opening balance	0.00
0.00		0.00	0.00	Salaries- Manpower	0.00
				Consumables	0.00
				Contingencies	0.00
				Travel	0.00
				Overheads	0.00
				Equipment	0.00
	Excess of expenditure over income	605714.00	18356.00		
624070.00			605714.00	18356.00	
624070.00		605714.00	624070.00	Closing Balance	605714.00
					605714.00

CENTRE FOR DNA FINGERPRINTING AND DIAGNOSTICS, HYDERABAD					
P-47 DRDO - DBT Project on "RESEARCH CUM TRAINING FOR DRDO PROGRAMME"					
P.I. Dr J GOWRISHANKAR, Dr S MAHALINGAM, Dr SHEKAR C MANDE, Dr J NAGARAJU & Dr NIYAZ AHMED					
RECEIPTS AND PAYMENTS ACCOUNT FROM 01.04.2011 TO 31.03.2012					
Previous Year Amount Rs	Receipts	Current Year Amount Rs.	Previous Year Amount Rs	Payments	Current Year Amount Rs
0.00	Opening Balance	0.00	1586965.00	Opening balance	1586965.00
0.00	Grant in aid	0.00	0.00	Salaries - Manpower	0.00
				Consumables	0.00
				Contingencies	0.00
				Travel	0.00
				Overheads	0.00
				Equipment	0.00
0.00		0.00	1586965.00		
1586965.00	Excess of expenditure over income	1586965.00			
1586965.00		1586965.00	1586965.00		1586965.00

CENTRE FOR DNA FINGERPRINTING AND DIAGNOSTICS, HYDERABAD					
P-48 DBT Project on "MOLECULAR CHARACTERIZATION OF HUMAN LIVER STEM CELLS FOR USE IN THE TREATMENT OF HEPATIC DISEASES"					
P.I. Dr SANJEEV KHOSLA					
RECEIPTS AND PAYMENTS ACCOUNT FROM 01.04.2011 TO 31.03.2012					
Previous Year Amount Rs	Receipts	Current Year Amount Rs.	Previous Year Amount Rs	Payments	Current Year Amount Rs
151826.00	Opening Balance	151826.00	0.00	Salaries - Manpower	0.00
0.00	Grant in aid	0.00	0.00	Consumables	0.00
				Contingencies	0.00
				Travel	0.00
				Overheads	0.00
				Equipment	0.00
151826.00		151826.00	0.00		
			151826.00	Closing balance	151826.00
151826.00		151826.00	151826.00		151826.00

CENTRE FOR DNA FINGERPRINTING AND DIAGNOSTICS, HYDERABAD						
P - 49 A: "GRANT SANCTIONED BY INTERNATIONAL ATOMIC ENERGY" - P.I. Dr J NAGARAJU						
RECEIPTS AND PAYMENTS ACCOUNT FROM 01.04.2011 TO 31.03.2012						
Previous Year Amount Rs	Receipts	Current Year Amount Rs.	Previous Year Amount Rs	Payments	Current Year Amount Rs	
470313.00	Opening Balance	470313.00	0.00	Salaries- Manpower	0.00	
0.00	Grant in aid	0.00	0.00	Consumables	0.00	
			0.00	Contingencies	0.00	
			0.00	Travel	29363.00	
			0.00	Overheads	0.00	
			0.00	Equipment	0.00	
470313.00		470313.00	0.00	Closing balance	29363.00	
470313.00		470313.00	470313.00		440950.00	
					470313.00	

CENTRE FOR DNA FINGERPRINTING AND DIAGNOSTICS, HYDERABAD						
P-51: DST Project on " UNDERSTANDING THE MECHANISM OF DOXORUBICIN RESISTANCE IN BREAST CANCER CELLINE MCF - 7						
P.I. Dr SUNIL KUMAR MANNA						
RECEIPTS AND PAYMENTS ACCOUNT FROM 01.04.2011 TO 31.03.2012						
Previous Year Amount Rs	Receipts	Current Year Amount Rs.	Previous Year Amount Rs	Payments	Current Year Amount Rs	
0.00	Opening Balance	0.00	284065.00	Opening Balance	284065.00	
0.00	Grant in aid	0.00	0.00	Salaries - Manpower	0.00	
			0.00	Consumables	0.00	
			0.00	Contingencies	0.00	
			0.00	Travel	0.00	
			0.00	Overheads	0.00	
			0.00	Equipment	0.00	
0.00		0.00	284065.00		284065.00	
284065.00	Excess of expenditure over income	284065.00				
284065.00		284065.00	284065.00		284065.00	

<p style="text-align: center;">CENTRE FOR DNA FINGERPRINTING AND DIAGNOSTICS, HYDERABAD P-52: DBT Project on "NUCLEO CYTOPLASMIC TRANSPORT OF HIV - 1 VPR" P.I. Dr S MAHALINGAM & Dr SUNIL KUMAR MANNA RECEIPTS AND PAYMENTS ACCOUNT FROM 01.04.2011 TO 31.03.2012</p>						
Previous Year Amount Rs	Receipts	Current Year Amount Rs.	Previous Year Amount Rs	Payments	Current Year Amount Rs	
0.00	Opening Balance	0.00	1231118.00	Opening Balance	1231118.00	
0.00	Grant in aid	0.00		Salaries - Manpower	0.00	
				Consumables	0.00	
				Contingencies	0.00	
				Travel	0.00	
				Overheads	0.00	
				Equipment	0.00	
0.00		0.00	1231118.00		1231118.00	
1231118.00	Excess of expenditure over income	1231118.00	0.00	Closing balance	0.00	
1231118.00		1231118.00	1231118.00		1231118.00	

<p style="text-align: center;">CENTRE FOR DNA FINGERPRINTING AND DIAGNOSTICS, HYDERABAD P-54: ICMR Project on "STUDY OF VIABILITY OF MYCOBACTERIUM LEPRAE IN CLINICAL SAMPLES AND POSSIBILITY OF ITS PRESENCE IN THE ENVIRONMENT USING NUCLEIC ACID AMPLIFICATION TECHNIQUES" P.I. Dr NIYAZ AHMED RECEIPTS AND PAYMENTS ACCOUNT FROM 01.04.2011 TO 31.03.2012</p>						
Previous Year Amount Rs	Receipts	Current Year Amount Rs.	Previous Year Amount Rs	Payments	Current Year Amount Rs	
0.00	Opening Balance	0.00	37877.00	Opening balance	37877.00	
0.00	Grant in aid	0.00	0.00	Salaries - Manpower	0.00	
			0.00	Consumables	0.00	
			0.00	Contingencies	0.00	
				Travel	0.00	
				Overheads	0.00	
				Equipment	0.00	
0.00		0.00	37877.00		37877.00	
37877.00	Excess of expenditure over income	37877.00	0.00	Closing Balance	0.00	
37877.00		37877.00	37877.00		37877.00	

CENTRE FOR DNA FINGERPRINTING AND DIAGNOSTICS, HYDERABAD						
P-55: DBT Project on " IDENTIFICATION OF DNA MARKERS FOR BACULOVIRUS RESISTANCE IN SILKWORM, <i>BOMBYX MORI</i> "						
P.I. Dr J NAGARAJU						
RECEIPTS AND PAYMENTS ACCOUNT FROM 01.04.2011 TO 31.03.2012						
Previous Year Amount	Receipts	Current Year Amount	Previous Year Amount	Payments	Current Year Amount	Rs
224.00	Opening Balance	224.00	0.00	Salaries - Manpower		0.00
0.00	Grant in aid	0.00	0.00	Consumables		0.00
			0.00	Contingencies		0.00
			0.00	Travel		0.00
			0.00	Overheads		0.00
			0.00	Equipment		0.00
224.00		224.00	0.00			0.00
			224.00	Closing Balance		224.00
224.00		224.00	224.00			224.00

CENTRE FOR DNA FINGERPRINTING AND DIAGNOSTICS, HYDERABAD						
P-56: DBT Project on " GENETICS OF TRANSCRIPTION - REPLICATION INTERPLAY AND OF STRESS ADAPTATION IN BACTERIA "						
P.I. Dr J GOWRISHANKAR						
RECEIPTS AND PAYMENTS ACCOUNT FROM 01.04.2011 TO 31.03.2012						
Previous Year Amount	Receipts	Current Year Amount	Previous Year Amount	Payments	Current Year Amount	Rs
0.00	Opening Balance		1231164.00	Opening Balance	1231164.00	0.00
0.00	Grant in aid	0.00	0.00	Salaries - Manpower		0.00
		0.00	0.00	Consumables		0.00
			0.00	Contingencies		0.00
			0.00	Travel		0.00
			0.00	Overheads		0.00
			0.00	Equipment		0.00
0.00		0.00	1231164.00			1231164.00
1231164.00	Excess of expenditure over income	1231164.00	0.00	Closing Balance		0.00
1231164.00		1231164.00	1231164.00			1231164.00

CENTRE FOR DNA FINGERPRINTING AND DIAGNOSTICS, HYDERABAD P-59: DBT Project on "AN INTEGRATED APPROACH TOWARDS UNDERSTANDING THE BIOLOGY OF MYCOBACTERIUM TUBERCULOSIS: GENETIC, BIOCHEMICAL, IMMUNOLOGICAL AND STRUCTURAL ANALYSES" P.I. - Dr S E HASNAIN, Dr J GOWRISHANKAR, Dr SHEKHAR C WANDE & Dr RANJAN SEN RECEIPTS AND PAYMENTS ACCOUNT FROM 01.04.2011 TO 31.03.2012					
Previous Year Amount Rs	Receipts	Current Year Amount Rs.	Previous Year Amount Rs	Payments	Current Year Amount Rs
0.00	Opening Balance	0.00	2215024.00	Opening Balance	2215024.00
0.00	Grant in aid	0.00	0.00	Salaries - Manpower	0.00
				Consumables	0.00
				Contingencies	0.00
				Travel	0.00
				Overheads	0.00
				Equipment	0.00
0.00		0.00	2215024.00		
2215024.00	Excess of expenditure over income	2215024.00	0.00	Closing Balance	2215024.00
2215024.00		2215024.00	2215024.00		2215024.00

CENTRE FOR DNA FINGERPRINTING AND DIAGNOSTICS, HYDERABAD P-60: DBT Project on "NATIONAL DATABASE OF PREVALENT GENETIC DISORDERS IN INDIA: DEVELOPMENT, CURATION AND SERVICES" P.I. Dr H A NAGARAJARAM RECEIPTS AND PAYMENTS ACCOUNT FROM 01.04.2011 TO 31.03.2012					
Previous Year Amount Rs	Receipts	Current Year Amount Rs.	Previous Year Amount Rs	Payments	Current Year Amount Rs
482124.00	Opening Balance	482124.00	0.00	Salaries - Manpower	0.00
0.00	Grant in aid	0.00	0.00	Consumables	0.00
				Contingencies	0.00
				Travel	0.00
				Overheads	0.00
				Equipment	0.00
482124.00		482124.00	0.00		
			482124.00	Closing Balance	482124.00
482124.00		482124.00	482124.00		482124.00

CENTRE FOR DNA FINGERPRINTING AND DIAGNOSTICS, HYDERABAD						
P-61: DST Project on "DISSECTION OF A NOVEL PHENOTYPE OF LETHAL ACCUMULATION OF POTASSIUM IN ESCHERICHIA COLI/MUTANTS DEFECTIVE IN THIOREDOXIN / THIOREDOXIN REDUCTASE AND NUCLEOIOD PROTEIN H-NS"						
P.I. ABHIJIT A SARDESAI						
RECEIPTS AND PAYMENTS ACCOUNT FROM 01.04.2011 TO 31.03.2012						
Previous Year Amount Rs	Receipts	Current Year Amount Rs.	Previous Year Amount Rs	Payments	Current Year Amount Rs	
0.00	Opening Balance	0.00	280000.00	Opening balance	280000.00	
0.00	Grant in aid	0.00		Salaries - Manpower	0.00	
				Consumables	0.00	
				Contingencies	0.00	
				Travel	0.00	
				Overheads	0.00	
				Equipment	0.00	
0.00		0.00	280000.00		280000.00	
280000.00	Excess of expenditure over income	280000.00				
280000.00		280000.00	280000.00		280000.00	

CENTRE FOR DNA FINGERPRINTING AND DIAGNOSTICS, HYDERABAD						
P-62: DBT Project on "HIV-1 PATHOGENESIS: ROLE OF INTEGRATE IN REVERSE TRANSCRIPTION AND NUCLEAR TRANSPORT OF VIRAL GENOME"						
P.I. Dr S MAHALINGAM						
RECEIPTS AND PAYMENTS ACCOUNT FROM 01.04.2011 TO 31.03.2012						
RECEIPTS AND PAYMENTS ACCOUNT FROM 01.04.2008 TO 31.03.2009						
Previous Year Amount Rs	Receipts	Current Year Amount Rs.	Previous Year Amount Rs	Payments	Current Year Amount Rs	
0.00	Opening Balance	0.00	278928.00	Opening Balance	278928.00	
0.00	Grant in aid	0.00		Salaries - Manpower	0.00	
				Consumables	0.00	
				Contingencies	0.00	
				Travel	0.00	
				Overheads	0.00	
				Equipment	0.00	
0.00		0.00	278928.00		278928.00	
278928.00	Excess of expenditure over income	278928.00	0.00	Closing Balance	0.00	
278928.00		278928.00	278928.00		278928.00	

CENTRE FOR DNA FINGERPRINTING AND DIAGNOSTICS, HYDERABAD						
P-63: DBT Project on "UPGRADATION OF THE EXISTING COMPUTING INFRASTRUCTURE AT THE BIOINFORMATICS FACILITY AT CDFD"						
P.I. Dr. SEYED E HASNAIN						
RECEIPTS AND PAYMENTS ACCOUNT FROM 01.04.2011 TO 31.03.2012						
Previous Year Amount Rs	Receipts	Current Year Amount Rs.	Previous Year Amount Rs	Payments	Current Year Amount Rs	
0.00	Opening Balance	0.00	837574.00	Opening balance	837574.00	
0.00	Grant in aid	0.00		Salaries -Manpower	0.00	
				Consumables	0.00	
				Contingencies	0.00	
				Travel	0.00	
				Overheads	0.00	
				Equipment	0.00	
0.00		0.00	837574.00			
837574.00	Excess of expenditure over income	837574.00				837574.00
837574.00		837574.00	837574.00			837574.00

CENTRE FOR DNA FINGERPRINTING AND DIAGNOSTICS, HYDERABAD						
P-64: NMITLI Project on "BIOTECHNOLOGY FOR LEATHER: TOWARDS CLEANER PROCESSING PHASE - II"						
P.I. Dr J GOWRISHANKAR						
RECEIPTS AND PAYMENTS ACCOUNT FROM 01.04.2011 TO 31.03.2012						
Previous Year Amount Rs	Receipts	Current Year Amount Rs.	Previous Year Amount Rs	Payments	Current Year Amount Rs	
0.00	Opening Balance	0.00	158.00	Opening Balance	158.00	
0.00	Grant in aid	0.00		Salaries - Manpower	0.00	
				Consumables	0.00	
				Contingencies	0.00	
				Travel	0.00	
				Overheads	0.00	
				Equipment	0.00	
0.00		0.00	158.00			
158.00	Excess of expenditure over income	158.00				158.00
158.00		158.00	158.00			158.00

CENTRE FOR DNA FINGERPRINTING AND DIAGNOSTICS, HYDERABAD P-65: DST Project on "MOLECULAR, GENETIC AND FUNCTIONAL ANALYSIS OF THE CHROMOSOMAL PLASTICITY REGION OF THE GASTRIC PATHOGEN HELICOBACTER PYLORI" PI. Dr AYESHA ALVI RECEIPTS AND PAYMENTS ACCOUNT FROM 01.04.2011 TO 31.03.2012					
Previous Year Amount Rs	Receipts	Current Year Amount Rs.	Previous Year. Amount Rs	Payments	Current Year Amount Rs
0.00	Opening Balance	0.00	582647.00	Opening balance	582647.00
0.00	Grant in aid	0.00	0.00	Salaries - Manpower	0.00
			0.00	Consumables	0.00
			0.00	Contingencies	0.00
			0.00	Travel	0.00
			0.00	Overheads	0.00
			0.00	Equipment	0.00
0.00		0.00	582647.00		582647.00
582647.00	Excess of expenditure over income	582647.00	0.00	Closing balance	0.00
582647.00		582647.00	582647.00		582647.00

CENTRE FOR DNA FINGERPRINTING AND DIAGNOSTICS, HYDERABAD P-65A: APEDA-CDFD Centre for Basmati DNA Analysis PI. Dr J NAGARAJU RECEIPTS AND PAYMENTS ACCOUNT FROM 01.04.2011 TO 31.03.2012					
Previous Year Amount Rs	Receipts	Current Year Amount Rs.	Previous Year. Amount Rs	Payments	Current Year Amount Rs
7477508.00	Opening Balance	16381715.00	0.00	Opening Balance	0.00
0.00	Grant in aid	0.00	521891.00	Salaries- Manpower	543948.00
1566000.00	Basmati Analysis Charges	1103400.00	100000.00	Consumables	2000000.00
8000000.00	AMC amount received	4000000.00	27450.00	Contingencies	0.00
			0.00	Travel	0.00
			0.00	Overheads	0.00
			0.00	Consultancy & Knowledge fee	0.00
			0.00	Vehicle	0.00
			12452.00	Equipment	3146.00
17043508.00	Excess of expenditure over income	21485115.00	661793.00		2547094.00
			16381715.00	Closing Balance	18938021.00
17043508.00		21485115.00	17043508.00		21485115.00

P-66: DBT Project on "HUMAN EPIGENOME VARIATION: ANALYSIS OF CPG ISLAND METHYLATION IN CHROMOSOMES 18 AND Y, AND IN SOME HOX, INSULIN SIGNALING AND CHROMATIN REPROGRAMMING GENES" PI. Dr SANJEEV KHOSLA RECEIPTS AND PAYMENTS ACCOUNT FROM 01.04.2011 TO 31.03.2012					
Previous Year Amount Rs	Receipts	Current Year Amount Rs.	Previous Year Amount Rs	Payments	Current Year Amount Rs
0.00	Opening Balance	0.00	684722.00	Opening Balance	681246.00
0.00	Grant in aid	0.00	0.00	Salaries - Manpower	0.00
			0.00	Consumables	0.00
			0.00	Contingencies	0.00
			0.00	Travel	0.00
			0.00	Overheads	0.00
			0.00	Equipment	0.00
0.00		0.00	681246.00		681246.00
681246.00	Excess of expenditure over income	681246.00	0.00	Closing Balance	0.00
681246.00		681246.00	681246.00		681246.00

P-67: DBT Project on "IDENTIFICATION OF NOVEL ESOPHAGEAL SQUAMOUS CELL CARCINOMA (ESCC) GENES BY USING A COMBINATION OF ARRAY-BASED CGH AND GENE EXPRESSION MICROARRAYS" PI. Dr M D BASHYAM RECEIPTS AND PAYMENTS ACCOUNT FROM 01.04.2011 TO 31.03.2012					
Previous Year Amount Rs	Receipts	Current Year Amount Rs.	Previous Year Amount Rs	Payments	Current Year Amount Rs
0.00	Opening Balance	0.00	113545.00	Opening Balance	113545.00
0.00	Grant in aid	0.00	0.00	Salaries - Manpower	0.00
			0.00	Consumables	0.00
			0.00	Contingencies	0.00
			0.00	Travel	0.00
			0.00	Overheads	0.00
			0.00	Equipment	0.00
0.00		0.00	113545.00		113545.00
113545.00	Excess of expenditure over income	113545.00	0.00		0.00
113545.00		113545.00	113545.00		113545.00

<p align="center">P-68: DST Project on "IDENTIFICATION OF HIGH RISK INDIVIDUAL WITH PRECANCEROUS STATES OF ESOPHAGAL CANCER" P.I. Dr GAYATRI RAMAKRISHNA RECEIPTS AND PAYMENTS ACCOUNT FROM 01.04.2011 TO 31.03.2012</p>					
Previous Year Amount Rs	Receipts	Current Year Amount Rs.	Previous Year Amount Rs	Payments	Current Year Amount Rs
0.00	Opening Balance	0.00	59874.00	Opening Balance	59874.00
0.00	Grant in aid	0.00		Salaries- Manpower	0.00
				Consumables	0.00
				Contingencies	0.00
				Travel	0.00
				Overheads	0.00
				Equipment	0.00
0.00		0.00	59874.00		59874.00
59874.00	Excess of expenditure over income	59874.00	0.00	Closing Balance	0.00
59874.00		59874.00	59874.00		59874.00

<p align="center">P-69: ICMR Project on "UNDERSTANDING THE ROLE OF PEIPE FAMILY OF M.TUBERCULOSIS IN THE ACTIVATION OF HIV VIRUS TYPE I LONG TERMINAL REPEAT (HIV-1LTP)" P.I. Dr SANGITA MUKHOPADHYAY RECEIPTS AND PAYMENTS ACCOUNT FROM 01.04.2011 TO 31.03.2012</p>					
Previous Year Amount Rs	Receipts	Current Year Amount Rs.	Previous Year Amount Rs	Payments	Current Year Amount Rs
0.00	Opening Balance	0.00	159363.00	Opening Balance	0.00
159363.00	Grant in aid	0.00		Salaries- Manpower	0.00
				Consumables	0.00
				Contingencies	0.00
				Travel	0.00
				Overheads	0.00
				Equipment	0.00
159363.00		0.00	159363.00		0.00
0.00	Excess of expenditure over income	0.00	0.00	Closing Balance	0.00
159363.00		0.00	159363.00		0.00

CENTRE FOR DNA FINGERPRINTING AND DIAGNOSTICS, HYDERABAD					
P-70: DBT Project on "IDENTIFICATION OF DISEASE CAUSING MUTATIONS IN FAMILIAL HYPERTROPHIC CARDIOMYOPATHY (FHC) PATIENTS FROM ANDHRA PRADESH"					
P.I. Dr M D BASHYAM					
RECEIPTS AND PAYMENTS ACCOUNT FROM 01.04.2011 TO 31.03.2012					
Previous Year Amount Rs	Receipts	Current Year Amount Rs.	Previous Year Amount Rs	Payments	Current Year Amount Rs
0.00	Opening Balance	0.00	21336.00	Opening Balance	21336.00
0.00	Grant in aid	0.00		Salaries - Manpower	0.00
				Consumables	0.00
				Contingencies	0.00
				Travel	0.00
				Overheads	0.00
				Equipment	0.00
0.00		0.00	21336.00		
21336.00	Excess of expenditure over income	21336.00	0.00	Closing Balance	21336.00
21336.00		21336.00	21336.00		21336.00

CENTRE FOR DNA FINGERPRINTING AND DIAGNOSTICS, HYDERABAD					
P-71: DBT Project on "REFERRAL CENTRE FOR GENETIC FIDELITY TESTING OF TISSUE CULTURE RAISED PLANTS"					
P.I. Dr N MADHUSUDAN REDDY					
RECEIPTS AND PAYMENTS ACCOUNT FROM 01.04.2011 TO 31.03.2012					
Previous Year Amount Rs	Receipts	Current Year Amount Rs.	Previous Year Amount Rs	Payments	Current Year Amount Rs
1808000.00	Opening Balance	0.00	1615249.00	Opening Balance	591490.00
0.00	Grant in aid	1020000.00	308942.00	Salaries- Manpower	187681.00
			400000.00	Consumables	200000.00
			50000.00	Contingencies	25000.00
			25299.00	Travel	0.00
			0.00	Overheads	0.00
			0.00	Equipment	0.00
1808000.00		1020000.00	2399490.00		
591490.00	Excess of expenditure over income	0.00	0.00	Closing Balance	1004171.00
2399490.00		1020000.00	2399490.00		1020000.00

CENTRE FOR DNA FINGERPRINTING AND DIAGNOSTICS, HYDERABAD					
P-72: DST Project on "NUANCES OF NON-CODING DNA NEAR INSULIN-RESPONSIVE GENES"					
P.I. Dr NIRMALA YABALURI					
RECEIPTS AND PAYMENTS ACCOUNT FROM 01.04.2011 TO 31.03.2012					
Previous Year Amount Rs	Receipts	Current Year Amount Rs.	Previous Year Amount Rs	Payments	Current Year Amount Rs
0.00	Opening Balance	0.00	1421653.00	Opening balance	1421653.00
0.00	Grant in aid	0.00		Salaries- Manpower	0.00
				Consumables	0.00
				Contingencies	0.00
				Travel	0.00
				Overheads	0.00
				Equipment	0.00
0.00		0.00	1421653.00		1421653.00
1421653.00	Excess of expenditure over income	1421653.00			
1421653.00		1421653.00	1421653.00		1421653.00

CENTRE FOR DNA FINGERPRINTING AND DIAGNOSTICS, HYDERABAD					
P-73: DST Project on "IDENTIFICATION AND CHARACTERIZATION OF PANCREATIC CANCER GENES LOCATED WITHIN NOVEL LOCALIZED CPY NUMBER ALTERNATIONS"					
P.I. Dr M D BASHYAM					
RECEIPTS AND PAYMENTS ACCOUNT FROM 01.04.2011 TO 31.03.2012					
Previous Year Amount Rs	Receipts	Current Year Amount Rs.	Previous Year Amount Rs	Payments	Current Year Amount Rs
0.00	Opening Balance		857136.00	Opening Balance	857136.00
	Grant in aid	0.00		Salaries - Manpower	0.00
				Consumables	0.00
				Contingencies	0.00
				Travel	0.00
				Overheads	0.00
				Equipment	0.00
0.00		0.00	857136.00		857136.00
857136.00	Excess of expenditure over income	857136.00			
857136.00		857136.00	857136.00		857136.00

CENTRE FOR DNA FINGERPRINTING AND DIAGNOSTICS, HYDERABAD						
P-75: DST Project on "PREPARING BLUEPRINT FOR THE MACROMOLECULAR CRYSTALLOGRAPHY BEAMLINE AT INDUS-II SYNCHROTRON SOURCE"						
P.I. Dr SHEKAR C MANDE						
RECEIPTS AND PAYMENTS ACCOUNT FROM 01.04.2011 TO 31.03.2012						
Previous Year Amount Rs	Receipts	Current Year Amount Rs.	Previous Year Amount Rs	Payments	Current Year Amount Rs	
0.00	Opening Balance	0.00	10840.00	Opening Balance	10840.00	
0.00	Grant in aid	0.00		Salaries - Manpower	0.00	
				Consumables	0.00	
				Contingencies	0.00	
				Travel	0.00	
				Overheads	0.00	
				Equipment	0.00	
0.00		0.00	10840.00		10840.00	
10840.00	Excess of expenditure over income	10840.00	0.00	Closing Balance	0.00	
10840.00		10840.00	10840.00		10840.00	

CENTRE FOR DNA FINGERPRINTING AND DIAGNOSTICS, HYDERABAD						
P-76: DBT project on "A STUDY OF MOLECULAR MARKERS IN CHILDHOOD AUTISM WITH SPECIAL REFERENCES TO NUCLEAR FACTORS - KAPPA B"						
P.I. Dr SUNIL KUMAR MANNA						
RECEIPTS AND PAYMENTS ACCOUNT FROM 01.04.2011 TO 31.03.2012						
Previous Year Amount Rs	Receipts	Current Year Amount Rs.	Previous Year Amount Rs	Payments	Current Year Amount Rs	
0.00	Opening Balance	0.00	50234.00	Opening Balance	50234.00	
0.00	Grant in aid	0.00		Salaries - Manpower	0.00	
				Consumables	0.00	
				Contingencies	0.00	
				Travel	0.00	
				Overheads	0.00	
				Equipment	0.00	
0.00		0.00	50234.00		50234.00	
50234.00	Excess of expenditure over income	50234.00	0.00	Closing Balance	0.00	
50234.00		50234.00	50234.00		50234.00	

<p style="text-align: center;">CENTRE FOR DNA FINGERPRINTING AND DIAGNOSTICS, HYDERABAD P-77 : DBT project on "FUNCTIONAL CHARACTERIZATION OF MYCOBACTERIUM TUBERCULOSIS PE/PE PROTEINS HAVING SH3 BINDING DOMAIN: UNDERSTANDING THEIR ROLE IN MODULATING MACROPHAGE FUNCTIONS" P.I. Dr SANGITA MUKHOPADHYAY RECEIPTS AND PAYMENTS ACCOUNT FROM 01.04.2011 TO 31.03.2012</p>									
Previous Year Amount	Rs	Receipts	Current Year Amount	Rs.	Previous Year Amount	Rs	Payments	Current Year Amount	Rs
126471.00	0.00	Opening Balance	124277.00	0.00	0.00	0.00	Opening Balance	0.00	0.00
		Grant in aid	0.00	0.00	0.00	0.00	Salaries- Manpower	0.00	0.00
					0.00	0.00	Consumables	0.00	0.00
					0.00	0.00	Contingencies	0.00	0.00
					0.00	0.00	Travel	0.00	0.00
					0.00	0.00	Overheads	0.00	0.00
					2194.00	2194.00	Equipment	0.00	0.00
126471.00	0.00	Excess of expenditure over income	124277.00	0.00	124277.00	124277.00	Closing Balance	124277.00	0.00
126471.00			124277.00		126471.00			124277.00	

<p style="text-align: center;">CENTRE FOR DNA FINGERPRINTING AND DIAGNOSTICS, HYDERABAD P-78: ICMR project on "TASK FORCE - IMD NEWBORN SCREENING FOR CONGENITAL HYPHYROIDISM & CONGENITAL ADRENAL HYPERPLASIA: A MULTICENTRIC STUDY" P.I. Dr A RADHA RAMA DEVI RECEIPTS AND PAYMENTS ACCOUNT FROM 01.04.2011 TO 31.03.2012</p>									
Previous Year Amount	Rs	Receipts	Current Year Amount	Rs.	Previous Year Amount	Rs	Payments	Current Year Amount	Rs
1304.00	0.00	Opening Balance	1304.00	0.00	0.00	0.00	Opening Balance	0.00	0.00
		Grant in aid	0.00	0.00	0.00	0.00	Salaries - Manpower	0.00	0.00
					0.00	0.00	Consumables	0.00	0.00
					0.00	0.00	Contingencies	0.00	0.00
					0.00	0.00	Travel	0.00	0.00
					0.00	0.00	Overheads	0.00	0.00
					0.00	0.00	Equipment	0.00	0.00
					0.00	0.00	Project funds refund	0.00	0.00
1304.00			1304.00		0.00	0.00	Closing Balance	1304.00	0.00
1304.00			1304.00		1304.00			1304.00	

CENTRE FOR DNA FINGERPRINTING AND DIAGNOSTICS, HYDERABAD					
P-79: DRDO project on "UNDERSTANDING THE ROLE OF AGE PROTEINS IN INDUCING INFLAMMATORY RESPONSES AND ITS REGULATION"					
P.I. Dr SUNIL KUMAR MANNA					
RECEIPTS AND PAYMENTS ACCOUNT FROM 01.04.2011 TO 31.03.2012					
Previous Year Amount	Receipts	Current Year Amount	Previous Year Amount	Payments	Current Year Amount
0.00	Opening Balance	0.00	2636028.00	Opening Balance	1900986.00
751300.00	Grant in aid	1795900.00	16258.00	Salaries- Manpower	0.00
			0.00	Consumables	0.00
			0.00	Contingencies	0.00
			0.00	Travel	0.00
			0.00	Overheads	0.00
			0.00	Equipment	0.00
751300.00		1795900.00	2652286.00		1900986.00
1900986.00	Excess of expenditure over income	105086.00	0.00	Closing Balance	0.00
2652286.00		1900986.00	2652286.00		1900986.00

CENTRE FOR DNA FINGERPRINTING AND DIAGNOSTICS, HYDERABAD					
P-80: DBT Project on "REFERRAL CENTRE FOR DETECTION OF GENETICALLY MODIFIED FOODS EMPLOYING DNA - BASED MARKETS"					
P.I. Dr N MADHUSUDAN REDDY					
RECEIPTS AND PAYMENTS ACCOUNT FROM 01.04.2011 TO 31.03.2012					
Previous Year Amount	Receipts	Current Year Amount	Previous Year Amount	Payments	Current Year Amount
0.00	Opening Balance	0.00	28471.00	Opening Balance	53994.00
0.00	Grant in aid	0.00	25523.00	Salaries- Manpower	0.00
			0.00	Consumables	0.00
			0.00	Contingencies	0.00
			0.00	Travel	0.00
			0.00	Overheads	0.00
			0.00	Equipment	0.00
			0.00	Project funds Refund	554228.00
0.00		0.00	53994.00		608222.00
53994.00	Excess of expenditure over income	608222.00	0.00	Closing Balance	0.00
53994.00		608222.00	53994.00		608222.00

CENTRE FOR DNA FINGERPRINTING AND DIAGNOSTICS, HYDERABAD						
P-81: DBT project on "RECONSTRUCTING CELLULAR NETWORKS: TWO COMPONENT REGULATORY SYSTEMS"						
P.I.: Dr SHEKAR C MANDE						
RECEIPTS AND PAYMENTS ACCOUNT FROM 01.04.2011 TO 31.03.2012						
Previous Year Amount	Receipts	Current Year Amount	Previous Year Amount	Payments	Current Year Amount	Rs
0.00	Opening Balance	214215.00	584848.00	Opening Balance		0.00
951800.00	Grant in aid	0.00	152737.00	Salaries- Manpower		70745.00
			0.00	Consumables		0.00
			0.00	Contingencies		0.00
			0.00	Travel		0.00
			0.00	Overheads		0.00
			0.00	Equipment		0.00
951800.00	Excess of expenditure over income	214215.00	737585.00			70745.00
			214215.00	Closing Balance		143470.00
951800.00		214215.00	951800.00			214215.00

CENTRE FOR DNA FINGERPRINTING AND DIAGNOSTICS, HYDERABAD						
P-81A : DST project : FINANCIAL ASSISTANCE FOR AWARD OF JC BOSE FELLOWSHIP TO						
Dr J GOWRISHANKAR						
RECEIPTS AND PAYMENTS ACCOUNT FROM 01.04.2011 TO 31.03.2012						
Previous Year Amount	Receipts	Current Year Amount	Previous Year Amount	Payments	Current Year Amount	Rs
0.00	Opening Balance	107800.00	280000.00	Salaries- Manpower		300000.00
1455000.00	Grant in aid	1300000.00	630841.00	Consumables		650000.00
			0.00	Contingencies		0.00
			258321.00	Travel		335180.00
			60000.00	Overheads		60000.00
			118038.00	Equipment		0.00
1455000.00		1407800.00	1347200.00			1345180.00
			107800.00	Closing Balance		62620.00
1455000.00		1407800.00	1455000.00			1407800.00

CENTRE FOR DNA FINGERPRINTING AND DIAGNOSTICS, HYDERABAD						
P-82: DBT project on "FUNCTIONAL GENOMIC ANALYSIS OF CANDIDA GLABRATA-MACROPHAGE"						
P.I.: Dr RUPINDER KAUR						
RECEIPTS AND PAYMENTS ACCOUNT FROM 01.04.2011 TO 31.03.2012						
Previous Year Amount	Receipts	Current Year Amount	Previous Year Amount	Payments	Current Year Amount	Current Year Rs
675598.00	Opening Balance	423591.00	186642.00	Salaries- Manpower	228020.00	
596000.00	Grant in aid	839000.00	300000.00	Consumables	800000.00	
			0.00	Contingencies	0.00	
			0.00	Travel	0.00	
			110609.00	Overheads	25091.00	
			250756.00	Equipment	53621.00	
1271598.00		1262591.00	848007.00		1106732.00	
0.00	Excess of expenditure over income	0.00	423591.00	Closing Balance	155859.00	
1271598.00		1262591.00	1271598.00		1262591.00	

CENTRE FOR DNA FINGERPRINTING AND DIAGNOSTICS, HYDERABAD						
P-83: DBT project on "PROKARYOTIC TRANSCRIPTION TERMINATION FACTOR, RHO: MECHANISM OF ACTION AND BIOLOGY"						
P.I. Dr RANJAN SEN						
RECEIPTS AND PAYMENTS ACCOUNT FROM 01.04.2011 TO 31.03.2012						
Previous Year Amount	Receipts	Current Year Amount	Previous Year Amount	Payments	Current Year Amount	Current Year Rs
0.00	Opening Balance	0.00	1093034.00	Opening Balance	1155594.00	
0.00	Grant in aid	0.00	62560.00	Salaries- Manpower	0.00	
			0.00	Consumables	0.00	
			0.00	Contingencies	0.00	
			0.00	Travel	0.00	
			0.00	Overheads	0.00	
			0.00	Equipment	0.00	
0.00		0.00	1155594.00		1155594.00	
1155594.00	Excess of expenditure over income	1155594.00		Closing Balance		
1155594.00		1155594.00	1155594.00		1155594.00	

CENTRE FOR DNA FINGERPRINTING AND DIAGNOSTICS, HYDERABAD						
P-83A: DST project on "UNDERSTANDING THE MECHANISM OF AZADIRACTHIN-MEDIATED CELL SIGNALING: ROLE IN ANTI-INFLAMMATION AND ANTI-TUMORIGENESIS"						
P.I. Dr SUNIL KUMAR MANNA						
RECEIPTS AND PAYMENTS ACCOUNT FROM 01.04.2011 TO 31.03.2012						
Previous Year Amount Rs	Receipts	Current Year Amount Rs.	Previous Year Amount Rs	Payments	Current Year Amount Rs	
0.00	Opening Balance	0.00	86075.00	Opening Balance	126140.00	
0.00	Grant in aid	0.00	40065.00	Salaries- Manpower	0.00	
			0.00	Consumables	0.00	
			0.00	Contingencies	0.00	
			0.00	Travel	0.00	
			0.00	Overheads	0.00	
			0.00	Equipment	0.00	
0.00		0.00	126140.00		126140.00	
126140.00	Excess of expenditure over income	126140.00	0.00	Closing Balance	0.00	
126140.00		126140.00	126140.00		126140.00	

CENTRE FOR DNA FINGERPRINTING AND DIAGNOSTICS, HYDERABAD						
P-84: Norway project on "PREPARING FOR TUBERCULOSIS VACCINE EFFICACY TRIALS: BASELINE EPIDEMIOLOGY, IMPROVED DIAGNOSIS, MARKERS OF PROTECTION AND PHASE VIII TRIALS"						
P.I. Dr NIYAZ AHMED						
RECEIPTS AND PAYMENTS ACCOUNT FROM 01.04.2011 TO 31.03.2012						
Previous Year Amount Rs	Receipts	Current Year Amount Rs.	Previous Year Amount Rs	Payments	Current Year Amount Rs	
0.00	Opening Balance	0.00	1150.00	Opening Balance	1150.00	
0.00	Grant in aid (Transfer from P-42)	0.00	0.00	Salaries - Manpower	0.00	
			0.00	Consumables	0.00	
			0.00	Contingencies	0.00	
			0.00	Travel	0.00	
			0.00	Overheads	0.00	
			0.00	Equipment	0.00	
0.00		0.00	1150.00		1150.00	
1150.00	Excess of expenditure over income	1150.00	0.00	Closing Balance	0.00	
1150.00		1150.00	1150.00		1150.00	

<p align="center">CENTRE FOR DNA FINGERPRINTING AND DIAGNOSTICS, HYDERABAD P-84A: DBT project on "HUMAN EPIGENETIC TO THE RESCUE OF HUMAN IDENTIFICATION PROCESS: ENRICHING HUMAN DNA FROM DNA MIXTURE EMPLOYING ANTIBODIES DIRECTED AGAINST 5-METHYL CYTOSINE FOLLOWED BY WHOLE GENOME AMPLIFICATION" P.I. Dr MADHUSUDAN REDDY RECEIPTS AND PAYMENTS ACCOUNT FROM 01.04.2011 TO 31.03.2012</p>					
Previous Year Amount Rs	Receipts	Current Year Amount Rs.	Previous Year Amount Rs	Payments	Current Year Amount Rs
655960.00	Opening Balance	676641.00	185640.00	Salaries- Manpower	248166.00
714000.00	Grant in aid	0.00	300000.00	Consumables	300000.00
			0.00	Contingencies	0.00
			0.00	Travel	0.00
			90433.00	Overheads	60667.00
			117246.00	Equipment	174287.00
1369960.00		676641.00	693319.00		783120.00
0.00	Excess of expenditure over income	106479.00	676641.00	Closing Balance	
1369960.00		783120.00	1369960.00		783120.00

<p align="center">CENTRE FOR DNA FINGERPRINTING AND DIAGNOSTICS, HYDERABAD P-85: DBT project on "IDER ASSOCIATED GENE REGULATORY NETWORK IN MYCOBACTERIA" P.I. Dr AKASH RANJAN RECEIPTS AND PAYMENTS ACCOUNT FROM 01.04.2011 TO 31.03.2011</p>					
Previous Year Amount Rs	Receipts	Current Year Amount Rs.	Previous Year Amount Rs	Payments	Current Year Amount Rs
0.00	Opening Balance	0.00	1118755.00	Salaries - Manpower	1118755.00
0.00	Grant in aid	0.00	0.00	Consumables	0.00
			0.00	Contingencies	0.00
			0.00	Travel	0.00
			0.00	Overheads	0.00
			0.00	Equipment	0.00
0.00		0.00	1118755.00		1118755.00
1118755.00	Excess of expenditure over income	1118755.00	0.00	Closing Balance	0.00
1118755.00		1118755.00	1118755.00		1118755.00

CENTRE FOR DNA FINGERPRINTING AND DIAGNOSTICS, HYDERABAD						
P-86: DBT project on "EVALUATION OF MYCOBACTERIUM WAS AN IMMUNOTHERAPEUTIC AGAINST PARATUBERCULOSIS (JOHN'S DISEASE OF CATTLE)"						
P.I. Dr NIYAZ AHMED						
RECEIPTS AND PAYMENTS ACCOUNT FROM 01.04.2011 TO 31.03.2012						
Previous Year Amount	Receipts	Current Year Amount	Previous Year Amount	Payments	Current Year Amount	Current Year Rs
78291.00	Opening Balance	0.00	18580.00	Salaries - Manpower		0.00
0.00	Grant in aid	0.00	0.00	Consumables		0.00
			0.00	Contingencies		0.00
			0.00	Travel		0.00
			0.00	Overheads		0.00
			59711.00	Equipment		0.00
78291.00	Excess of expenditure over income	0.00	78291.00	Project funds refund		0.00
0.00		0.00	0.00	Closing Balance		0.00
78291.00		0.00	78291.00			0.00

CENTRE FOR DNA FINGERPRINTING AND DIAGNOSTICS, HYDERABAD						
P-87: DST project on "COMPARATIVE GENOMIC OF WILD SILKMOTHS UNDER INDIA-JAPAN CO-OPERATIVE SCIENCE PROGRAMME (JJCSP)"						
P.I. Dr J NAGARAJU & Dr TORU SHIMADA						
RECEIPTS AND PAYMENTS ACCOUNT FROM 01.04.2011 TO 31.03.2012						
Previous Year Amount	Receipts	Current Year Amount	Previous Year Amount	Payments	Current Year Amount	Current Year Rs
0.00	Opening Balance	0.00	65698.00	Opening Balance		65698.00
0.00	Grant in aid	0.00	0.00	Salaries - Manpower		0.00
			0.00	Consumables		0.00
			0.00	Contingencies		0.00
			0.00	Travel		0.00
			0.00	Overheads		0.00
			0.00	Equipment		0.00
0.00	Excess of expenditure over income	0.00	65698.00	Closing Balance		65698.00
65698.00		65698.00	0.00			0.00
65698.00		65698.00	65698.00			65698.00

CENTRE FOR DNA FINGERPRINTING AND DIAGNOSTICS, HYDERABAD						
P - 88: DBT Project on "FINANCIAL ASSISTANCE FOR AWARD OF TATA INNOVATION FELLOWSHIP"						
P.I. Dr J NAGARAJU						
RECEIPTS AND PAYMENTS ACCOUNT FROM 01.04.2011 TO 31.03.2012						
Previous Year Amount Rs	Receipts	Current Year Amount Rs.	Previous Year Amount Rs	Payments	Current Year Amount Rs	
282465.00	Opening Balance	740000.00	240000.00	Salaries- Manpower	240000.00	
1480000.00	Grant in aid	0.00	640318.00	Consumables	0.00	
			0.00	Contingencies	0.00	
			142147.00	Travel	500000.00	
			0.00	Overheads	0.00	
			0.00	Equipment	0.00	
1762465.00		740000.00	1022465.00		740000.00	
0.00	Excess of expenditure over income	0.00	740000.00	Closing Balance	0.00	
1762465.00		740000.00	1762465.00		740000.00	

CENTRE FOR DNA FINGERPRINTING AND DIAGNOSTICS, HYDERABAD						
P-89: DBT Project on "CHARACTERIZATION OF MYCOBACTERIUM TUBERCULOSIS TRANSCRIPTION MACHINERY AND BACTERIOPHAGE METAGENOMICS"						
P.I. Dr RANJAN SEN						
RECEIPTS AND PAYMENTS ACCOUNT FROM 01.04.2011 TO 31.03.2012						
Previous Year Amount Rs.	Receipts	Current Year Amount Rs.	Previous Year Amount Rs	Payments	Current Year Amount Rs	
0.00	Opening Balance	0.00	300000.00	Opening Balance	300000.00	
300000.00	Grant in aid	300000.00	62240.00	Salaries - Manpower	0.00	
			234330.00	Consumables	0.00	
			0.00	Contingencies	0.00	
			0.00	Travel	0.00	
			0.00	Overheads	0.00	
			3430.00	Equipment	0.00	
300000.00		300000.00	600000.00		300000.00	
300000.00	Excess of expenditure over income	0.00	0.00	Closing Balance	0.00	
600000.00		300000.00	600000.00		300000.00	

CENTRE FOR DNA FINGERPRINTING AND DIAGNOSTICS, HYDERABAD						
P-90: DBT Project on "ROLE OF YAPINS IN THE PATHOBIOLOGY OF CANDIDA GLABRATA"						
P.I. Dr RUPINDER KAUR						
RECEIPTS AND PAYMENTS ACCOUNT FROM 01.04.2011 TO 31.03.2012						
Previous Year Amount Rs	Receipts	Current Year Amount Rs.	Previous Year Amount Rs	Payments	Current Year Amount Rs	
373213.00	Opening Balance	0.00	0.00	Opening Balance	451999.00	
0.00	Grant in aid	0.00	217783.00	Salaries- Manpower	141408.00	
		618700.00	500000.00	Consumables	300000.00	
			20000.00	Contingencies	20000.00	
			35904.00	Travel	19425.00	
			0.00	Overheads	0.00	
			51525.00	Equipment	322154.00	
373213.00		618700.00	825212.00	Closing Balance	1254986.00	
451999.00	Excess of expenditure over income	636286.00				
825212.00		1254986.00	825212.00		1254986.00	

CENTRE FOR DNA FINGERPRINTING AND DIAGNOSTICS, HYDERABAD						
P-91: DBT Project on "DNMT3L: EPIGENETIC CORRELATION WITH CANCER"						
P.I. Dr SANJEEV KHOSLA & Dr GAYATRI RAMAKRISHNA						
RECEIPTS AND PAYMENTS ACCOUNT FROM 01.04.2011 TO 31.03.2012						
Previous Year Amount Rs	Receipts	Current Year Amount Rs.	Previous Year Amount Rs	Payments	Current Year Amount Rs	
174154.00	Opening Balance	0.00	0.00	Opening Balance	787064.00	
0.00	Grant in aid	0.00	187839.00	Salaries- Manpower	83700.00	
			700000.00	Consumables	200000.00	
			300000.00	Contingencies	200000.00	
			35751.00	Travel	8136.00	
			0.00	Overheads	0.00	
			7628.00	Equipment	0.00	
174154.00		0.00	961218.00	Closing Balance	1098900.00	
787064.00	Excess of expenditure over income	1098900.00				
961218.00		1098900.00	961218.00		1098900.00	

CENTRE FOR DNA FINGERPRINTING AND DIAGNOSTICS, HYDERABAD					
P-92 : DST project on "SWARNAJAYANTIFELLOWSHIP: DESIGNING TRANSCRIPTION ANTI-TERMINATORS: A NOVEL APPROACH FOR MAKING NEW INHIBITORS OF GENE EXPRESSION"					
P.I. Dr RANJAN SEN					
RECEIPTS AND PAYMENTS ACCOUNT FROM 01.04.2011 TO 31.03.2012					
Previous Year Amount	Receipts	Current Year Amount	Previous Year Amount	Payments	Current Year Amount
0.00	Opening Balance		73314.00	Opening Balance	1238545.00
3132400.00	Grant in aid	0.00	675382.00	Salaries- Manpower	635400.00
		3500000.00	1800000.00	Consumables	2300000.00
			20000.00	Contingencies	50000.00
			99283.00	Travel	44674.00
			80000.00	Overheads	120000.00
			1622966.00	Equipment	371842.00
3132400.00		3500000.00	4370945.00		4760461.00
1238545.00	Excess of expenditure over income	1260461.00	0.00	Closing Balance	0.00
4370945.00		4760461.00	4370945.00		4760461.00

CENTRE FOR DNA FINGERPRINTING AND DIAGNOSTICS, HYDERABAD					
P-93: DBT Project on "VIRTUAL CENTRE OF EXCELLENCE ON MULTIDISCIPLINARY APPROACHES AIMED AT INTERVENTIONS AGAINST TUBERCULOSIS"					
P.I. Dr SHEKAR C MANDE & Dr SANGITA MUKHOPADHYAY					
RECEIPTS AND PAYMENTS ACCOUNT FROM 01.04.2011 TO 31.03.2012					
Previous Year Amount	Receipts	Current Year Amount	Previous Year Amount	Payments	Current Year Amount
817860.00	Opening Balance		0.00	Opening Balance	684179.00
657000.00	Grant in aid	0.00	869521.00	Salaries- Manpower	1560757.00
		2010000.00	900000.00	Consumables	1050000.00
			90000.00	Contingencies	100000.00
			14406.00	Travel	2769.00
			0.00	Overheads	0.00
			285112.00	Equipment	119181.00
1474860.00		2010000.00	2159039.00		3516886.00
684179.00	Excess of expenditure over income	1506886.00		Closing Balance	
2159039.00		3516886.00	2159039.00		3516886.00

CENTRE FOR DNA FINGERPRINTING AND DIAGNOSTICS, HYDERABAD					
P-95: DST Project on "CONSTRUCTION OF REGULATORY NETWORKS IN PROKARYOTES THROUGH PROTEIN: PROTEIN INTERACTION PREDICTIONS AND TRANSCRIPTION REGULATION PREDICTIONS."					
P.I. Dr SHEKAR C MANDE					
RECEIPTS AND PAYMENTS ACCOUNT FROM 01.04.2011 TO 31.03.2012					
Previous Year Amount Rs	Receipts	Current Year Amount Rs.	Previous Year. Amount Rs	Payments	Current Year Amount Rs
0.00	Opening Balance	424041.00	121469.00	Opening balance	0.00
700000.00	Grant in aid	0.00	154490.00	Salaries- Manpower	0.00
			0.00	Consumables	0.00
			0.00	Contingencies	0.00
			0.00	Travel	0.00
			0.00	Overheads	0.00
			0.00	Equipment	0.00
700000.00		424041.00	0.00	Project funds refund	424041.00
0.00	Excess of expenditure over income	0.00	275959.00		424041.00
			424041.00	Closing Balance	0.00
700000.00		424041.00	700000.00		424041.00

CENTRE FOR DNA FINGERPRINTING AND DIAGNOSTICS, HYDERABAD					
P-96 : NIH / FIRCA Project on "MOLECULAR CHARACTERIZATION OF SPORADIC COLORECTAL CANCER IN THE YOUNG FROM INDIA"					
P.I. Dr M D BASHYAM					
RECEIPTS AND PAYMENTS ACCOUNT FROM 01.04.2011 TO 31.03.2012					
Previous Year Amount Rs	Receipts	Current Year Amount Rs.	Previous Year. Amount Rs	Payments	Current Year Amount Rs
0.00	Opening Balance	0.00	1187015.00	Opening Balance	655942.00
1251970.00	Grant in aid	1452712.00	404743.00	Salaries- Manpower	26700.00
			0.00	Consumables	713546.00
			0.00	Contingencies	0.00
			316154.00	Travel	56524.00
			0.00	Overheads	0.00
			0.00	Equipment	0.00
1251970.00		1452712.00	1907912.00		1452712.00
655942.00	Excess of expenditure over income	0.00	0.00	Closing Balance	0.00
1907912.00		1452712.00	1907912.00		1452712.00

CENTRE FOR DNA FINGERPRINTING AND DIAGNOSTICS, HYDERABAD P-97 : DBT Project on "PROTEOME-WIDE ANALYSIS OF SERINE PYROPHOSPHORYLATION BY INOSITOL PYROPHOSPHATES" P.I. Dr RASHNA BHANDARI RECEIPTS AND PAYMENTS ACCOUNT FROM 01.04.2011 TO 31.03.2012					
Previous Year Amount Rs	Receipts	Current Year Amount Rs.	Previous Year. Amount Rs	Payments	Current Year Amount Rs
582700.00	Opening Balance	488524.00	192232.00	Salaries- Manpower	198439.00
835000.00	Grant in aid	532000.00	600000.00	Consumables	575300.00
			0.00	Contingencies	0.00
			0.00	Travel	24700.00
			121197.00	Overheads	0.00
			15747.00	Equipment	320549.00
1417700.00		1020524.00	929176.00		1118988.00
0.00	Excess of expenditure over income	98464.00	488524.00	Closing Balance	0.00
1417700.00		1118988.00	1417700.00		1118988.00

256

CENTRE FOR DNA FINGERPRINTING AND DIAGNOSTICS, HYDERABAD P-98 : DBT Project on "ROLE OF CELL - CELL SIGNALING MEDIATED BY DIFFUSIBLE SIGNALING FACTOR (DSF) IN XANTHOMONAS VIRULENCE" P.I. Dr SUBHADEEP CHATTERJEE RECEIPTS AND PAYMENTS ACCOUNT FROM 01.04.2011 TO 31.03.2012					
Previous Year Amount Rs	Receipts	Current Year Amount Rs.	Previous Year. Amount Rs	Payments	Current Year Amount Rs
812907.00	Opening Balance	0.00	0.00	Opening Balance	466554.00
290000.00	Grant in aid	0.00	187200.00	Salaries- Manpower	149240.00
		1641200.00	900000.00	Consumables	900000.00
			10000.00	Contingencies	10000.00
			7331.00	Travel	19240.00
			0.00	Overheads	0.00
			464930.00	Equipment	159185.00
1102907.00		1641200.00	1569461.00		1704219.00
466554.00	Excess of expenditure over income	63019.00	0.00	Closing Balance	0.00
1569461.00		1704219.00	1569461.00		1704219.00

<p align="center">P-99 : DBT Project on "ROLE OF INOSITOL PYROPHOSPHATES IN EUKARYOTIC CELL GROWTH, PROLIFERATION AND RIBOSOMAE BIOGENESIS" CENTRE FOR DNA FINGERPRINTING AND DIAGNOSTICS, HYDERABAD P.I. Dr RASHNA BHANDARI RECEIPTS AND PAYMENTS ACCOUNT FROM 01.04.2011 TO 31.03.2012</p>					
Previous Year Amount Rs	Receipts	Current Year Amount Rs.	Previous Year Amount Rs	Payments	Current Year Amount Rs
1663500.00	Opening Balance	0.00	0.00	Opening Balance	113757.00
0.00	Grant in aid	726299.00	269496.00	Salaries- Manpower	366800.00
			800000.00	Consumables	800000.00
			500000.00	Contingencies	50000.00
			33721.00	Travel	8253.00
			0.00	Overheads	0.00
			624040.00	Equipment	649389.00
1663500.00		726299.00	1777257.00	Closing Balance	1988199.00
113757.00	Excess of expenditure over income	1261900.00			
1777257.00		1988199.00	1777257.00		1988199.00

<p align="center">P-100: DBT Project on "EFFECT OF REACTIVE OXYGEN SPECIES ON T-CELL IMMUNE RESPONSE: AN APPROACH TO UNDERSTAND THE MOLECULAR MECHANISM OF IMMUNOSUPPRESSION DURING TUBERCULOSIS" - NATIONAL BIOSCIENCE AWARD CENTRE FOR DNA FINGERPRINTING AND DIAGNOSTICS, HYDERABAD P.I. Dr SANGITA MUKHOPADHAYAY RECEIPTS AND PAYMENTS ACCOUNT FROM 01.04.2011 TO 31.03.2012</p>					
Previous Year Amount Rs	Receipts	Current Year Amount Rs.	Previous Year Amount Rs	Payments	Current Year Amount Rs
0.00	Opening Balance	0.00	0.00	Opening Balance	300000.00
0.00	Grant in aid	0.00	203350.00	Salaries- Manpower	30000.00
			96650.00	Consumables	0.00
			0.00	Contingencies	5000.00
			0.00	Travel	0.00
			0.00	Overheads	0.00
			0.00	Equipment	0.00
0.00		0.00	300000.00	Closing Balance	335000.00
300000.00	Excess of expenditure over income	335000.00	0.00		0.00
300000.00		335000.00	300000.00		335000.00

CENTRE FOR DNA FINGERPRINTING AND DIAGNOSTICS, HYDERABAD P-101 : WT-DBT Alliance Project on "ROLE OF INOSITOL PYROPHOSPHATES IN CELL PHYSIOLOGY: INVESTIGATING THE BIOCHEMICAL SIGNIFICANCE OF PROTEIN PYROPHOSPHORYLATION - SENIOR FELLOWSHIP" P.I. Dr RASHNA BHANDARI RECEIPTS AND PAYMENTS ACCOUNT FROM 01.04.2011 TO 31.03.2012					
Previous Year Amount Rs	Receipts	Current Year Amount Rs.	Previous Year. Amount Rs	Payments	Current Year Amount Rs
15288801.00	Opening Balance	15688931.00	1878334.00	Salaries- Manpower	1787120.00
6784587.00	Grant in aid	4470916.00	1800000.00	Consumables	1100000.00
			0.00	Contingencies	0.00
			159823.00	Travel	73814.00
			580405.00	Overheads	584586.00
			1965895.00	Equipment	2884926.00
22073388.00		20159847.00	6384457.00	Closing Balance	6430446.00
22073388.00		20159847.00	15688931.00		13729401.00
			22073388.00		20159847.00

CENTRE FOR DNA FINGERPRINTING AND DIAGNOSTICS, HYDERABAD P-102 : ICMR Project on "UNDERSTANDING THE ROLE OF MYCOBACTERIUM TUBERCULOSIS HEAT SHOCKPROTEIN 60 AS TH1/TH2 IMMUNO MODULAR" P.I. Dr SANGITA MUKHOPADHYAY RECEIPTS AND PAYMENTS ACCOUNT FROM 01.04.2011 TO 31.03.2012					
Previous Year Amount Rs	Receipts	Current Year Amount Rs.	Previous Year. Amount Rs	Payments	Current Year Amount Rs
0.00	Opening Balance	0.00	483681.00	Opening Balance	445133.00
1181319.00	Grant in aid	1086164.00	234600.00	Salaries- Manpower	289800.00
			700000.00	Consumables	200000.00
			0.00	Contingencies	0.00
			0.00	Travel	20627.00
			0.00	Overheads	25000.00
1181319.00		1086164.00	208171.00	Equipment	22950.00
445133.00	Excess of expenditure over income		1626452.00	Closing Balance	1003510.00
1626452.00		1086164.00	0.00		82654.00
			1626452.00		1086164.00

CENTRE FOR DNA FINGERPRINTING AND DIAGNOSTICS, HYDERABAD P-103: DBT Project on "NATIONAL BIOSCIENCE AWARD - REGULATION OF MAST CELL SIGNALING, APOPTOSIS AND SURFACE RECEPTORS" P.I. Dr SUNIL KUMAR MANNA RECEIPTS AND PAYMENTS ACCOUNT FROM 01.04.2011 TO 31.03.2012					
Previous Year Amount Rs	Receipts	Current Year Amount Rs.	Previous Year Amount Rs	Payments	Current Year Amount Rs
0.00	Opening Balance	0.00	0.00	Salaries - Manpower	0.00
300000.00	Grant in aid	0.00	0.00	Consumables	300000.00
			300000.00	Contingencies	0.00
			0.00	Travel	0.00
			0.00	Overheads	0.00
			0.00	Equipment	0.00
300000.00		300000.00	0.00		300000.00
0.00	Excess of expenditure over income	0.00	300000.00	Closing Balance	0.00
300000.00		300000.00	300000.00		300000.00

CENTRE FOR DNA FINGERPRINTING AND DIAGNOSTICS, HYDERABAD P-104: DBT Project on "VIRTUAL CENTRE OF EXCELLENCE ON EPIGENETICS - PROJECT 4: EPIGENETIC DYNAMICS IN CELL TYPES AND ITS POTENTIAL ASSOCIATION WITH ENVIRONMENT AND DISEASE" P.I. Dr SANJEEV KHOSLA RECEIPTS AND PAYMENTS ACCOUNT FROM 01.04.2011 TO 31.03.2012					
Previous Year Amount Rs	Receipts	Current Year Amount Rs.	Previous Year Amount Rs	Payments	Current Year Amount Rs
0.00	Opening Balance	297613.00	398371.00	Salaries- Manpower	484709.00
1437000.00	Grant in aid	0.00	700000.00	Consumables	1100000.00
			30000.00	Contingencies	70000.00
			11016.00	Travel	37770.00
			0.00	Overheads	0.00
			0.00	Equipment	0.00
1437000.00		297613.00	1139387.00		1692479.00
	Excess of expenditure over income	1394866.00	297613.00	Closing Balance	
1437000.00		1692479.00	1437000.00		1692479.00

CENTRE FOR DNA FINGERPRINTING AND DIAGNOSTICS, HYDERABAD P-105 : DBT Project on "CLONING, CHARACTERISATION AND ANALYSIS OF CHROMOSOMAL REARRANGEMENTS IN HUMAN GENETIC DISORDERS" P.I. Dr ASHWIN DALAL RECEIPTS AND PAYMENTS ACCOUNT FROM 01.04.2011 TO 31.03.2012					
Previous Year Amount Rs	Receipts	Current Year Amount Rs.	Previous Year. Amount Rs	Payments	Current Year Amount Rs
0.00	Opening Balance	145971.00	157040.00	Salaries- Manpower	187200.00
827000.00	Grant in aid	681000.00	500000.00	Consumables	700000.00
			20000.00	Contingencies	20000.00
			3989.00	Travel	10615.00
			0.00	Overheads	0.00
			0.00	Equipment	0.00
827000.00		826971.00	681029.00		917815.00
	Excess of expenditure over income	90844.00	145971.00	Closing Balance	0.00
827000.00		917815.00	827000.00		917815.00

CENTRE FOR DNA FINGERPRINTING AND DIAGNOSTICS, HYDERABAD P-106 : ICMR Project on "CLINICAL, BIOCHEMICAL AND MOLECULAR ANALYSIS OF TREATABLE LYSOSOMAL STORAGE DISORDERS" P.I. Dr ASHWIN DALAL RECEIPTS AND PAYMENTS ACCOUNT FROM 01.04.2011 TO 31.03.2012					
Previous Year Amount Rs	Receipts	Current Year Amount Rs.	Previous Year. Amount Rs	Payments	Current Year Amount Rs
0.00	Opening Balance	0.00	0.00	Opening Balance	446056.00
238302.00	Grant in aid	0.00	214425.00	Salaries- Manpower	484977.00
		1602302.00	450000.00	Consumables	450000.00
			0.00	Contingencies	30317.00
			0.00	Travel	0.00
			19933.00	Overheads	0.00
			0.00	Equipment	0.00
238302.00		1602302.00	684358.00		1411350.00
446056.00	Excess of expenditure over income	0.00	0.00	Closing Balance	190952.00
684358.00		1602302.00	684358.00		1602302.00

CENTRE FOR DNA FINGERPRINTING AND DIAGNOSTICS, HYDERABAD					
P-107: DBT IYBA Project on "MECHANISM AND ROLE OF BACTERIAL CELL-CELL SIGNALING MOLECULES IN PLANT DEFENSE RESPONSE"					
P.I. Dr SUBHADEEP CHATTERJEE					
RECEIPTS AND PAYMENTS ACCOUNT FROM 01.04.2011 TO 31.03.2012					
Previous Year Amount	Receipts	Current Year Amount Rs.	Previous Year Amount Rs	Payments	Current Year Amount Rs
0.00	Opening Balance	602006.00	109200.00	Salaries- Manpower	187200.00
2027000.00	Grant in aid	773000.00	600000.00	Consumables	600000.00
			0.00	Contingencies	0.00
			0.00	Travel	0.00
			185869.00	Overheads	54131.00
			529925.00	Equipment	470075.00
2027000.00		1375006.00	1424994.00	Closing Balance	1311406.00
2027000.00		1375006.00	2027000.00		1375006.00

CENTRE FOR DNA FINGERPRINTING AND DIAGNOSTICS, HYDERABAD					
P-108 : DBT Project on "ESTABLISHMENT OF EBV TRANSFORMED CELL LINES FROM FAMILIES WITH RARE GENETIC DISORDERS"					
P.I. Dr ASHWIN DALAL					
RECEIPTS AND PAYMENTS ACCOUNT FROM 01.04.2011 TO 31.03.2012					
Previous Year Amount	Receipts	Current Year Amount Rs.	Previous Year Amount Rs	Payments	Current Year Amount Rs
0.00	Opening Balance	184023.00	112220.00	Salaries- Manpower	187200.00
487000.00	Grant in aid	470400.00	150000.00	Consumables	350000.00
		20000.00	Contingencies	30000.00	
		20757.00	Travel	17298.00	
		0.00	Overheads	0.00	
		0.00	Equipment	0.00	
487000.00		654423.00	302977.00	Closing Balance	584498.00
487000.00		654423.00	184023.00		69625.00
			487000.00		654423.00

<p align="center">CENTRE FOR DNA FINGERPRINTING AND DIAGNOSTICS, HYDERABAD P-109: DBT IYBA Project on "MOLECULAR DISSECTION OF PI3-KINASE/AKT PATHWAY BY USING PROTEOMICS BASED APPROACH: A STUDY TO IDENTIFY NOVEL POTENTIAL ONCOGENES AND TUMOR SUPPRESSORS" P.I. Dr M SUBBA REDDY RECEIPTS AND PAYMENTS ACCOUNT FROM 01.04.2011 TO 31.03.2012</p>									
Previous Year Amount	Rs	Receipts	Current Year Amount	Rs.	Previous Year Amount	Rs	Payments	Current Year Amount	Rs
0.00		Opening Balance	1476104.00		79040.00		Salaries- Manpower	187200.00	
2027000.00		Grant in aid	742000.00		400000.00		Consumables	800000.00	
					0.00		Contingencies	0.00	
					0.00		Travel	0.00	
					71856.00		Overheads	0.00	
					0.00		Equipment	915278.00	
2027000.00			2218104.00		550896.00		Closing Balance	1902478.00	
					1476104.00			315626.00	
2027000.00			2218104.00		2027000.00			2218104.00	

<p align="center">CENTRE FOR DNA FINGERPRINTING AND DIAGNOSTICS, HYDERABAD P-110: DST Project on "INDIA-JAPAN RESEARCH PROJECT TITLE"IDENTIFICATION AND ANALYSIS OF SEX DETERMINING GENES IN SILKMOTHS" P.I. Dr J NAGARAJU RECEIPTS AND PAYMENTS ACCOUNT FROM 01.04.2011 TO 31.03.2012</p>									
Previous Year Amount	Rs	Receipts	Current Year Amount	Rs.	Previous Year Amount	Rs	Payments	Current Year Amount	Rs
0.00		Opening Balance	24389.00		0.00		Salaries- Manpower	0.00	
170000.00		Grant in aid	0.00		0.00		Consumables	0.00	
					0.00		Contingencies	0.00	
					145611.00		Travel	193068.00	
					0.00		Overheads	0.00	
					0.00		Equipment	0.00	
170000.00			24389.00		145611.00		Closing Balance	193068.00	
					24389.00				
170000.00		Excess of expenditure over income	168679.00		170000.00			193068.00	
			193068.00						

CENTRE FOR DNA FINGERPRINTING AND DIAGNOSTICS, HYDERABAD P-111: DBT Ramalingaswami Fellowship "REFRACTORINESS MECHANISM IN MOSQUITO: CRACKING MOLECULAR CODES AT GENOMIC SCALE" P.I. Dr SHEWTA TYAGI RECEIPTS AND PAYMENTS ACCOUNT FROM 01.04.2011 TO 31.03.2012					
Previous Year Amount Rs	Receipts	Current Year Amount Rs.	Previous Year Amount Rs	Payments	Current Year Amount Rs
0.00	Opening Balance	488631.00	610028.00	Salaries- Manpower	1168400.00
1400000.00	Grant in aid	1511500.00	300000.00	Consumables	400000.00
			0.00	Contingencies	0.00
			1341.00	Travel	0.00
			0.00	Overheads	0.00
			0.00	Equipment	0.00
1400000.00		2000131.00	911369.00		1568400.00
			488631.00	Closing Balance	431731.00
1400000.00		2000131.00	1400000.00		2000131.00

CENTRE FOR DNA FINGERPRINTING AND DIAGNOSTICS, HYDERABAD P-112: DBT Ramanujan Fellowship P.I. Dr ROHIT JOSHI RECEIPTS AND PAYMENTS ACCOUNT FROM 01.04.2011 TO 31.03.2012					
Previous Year Amount Rs	Receipts	Current Year Amount Rs.	Previous Year Amount Rs	Payments	Current Year Amount Rs
0.00	Opening Balance	803726.00	404691.00	Salaries- Manpower	626400.00
1460000.00	Grant in aid	1000000.00	200000.00	Consumables	157326.00
			0.00	Contingencies	0.00
			11583.00	Travel	0.00
			40000.00	Overheads	20000.00
			0.00	Equipment	0.00
			0.00	Project funds refund	1000000.00
1460000.00		1803726.00	656274.00		1803726.00
			803726.00	Closing Balance	0.00
1460000.00		1803726.00	1460000.00		1803726.00

CENTRE FOR DNA FINGERPRINTING AND DIAGNOSTICS, HYDERABAD					
P-113: ICMR Project on "CLINICAL AND MOLECULAR GENETIC ANALYSIS OF SQUAMOUS CELL CARCINOMA OF THE TONGUE"					
P.I. Dr M D BASHYAM					
RECEIPTS AND PAYMENTS ACCOUNT FROM 01.04.2011 TO 31.03.2012					
Previous Year Amount Rs	Receipts	Current Year Amount Rs.	Previous Year Amount Rs	Payments	Current Year Amount Rs
0.00	Opening Balance	550715.00	110542.00	Salaries- Manpower	519587.00
1139487.00	Grant in aid	848689.00	200000.00	Consumables	320000.00
			0.00	Contingencies	0.00
			0.00	Travel	0.00
			9316.00	Overheads	25187.00
			268914.00	Equipment	0.00
1139487.00		1399404.00	588772.00	Closing Balance	864774.00
			550715.00		534630.00
1139487.00		1399404.00	1139487.00		1399404.00

CENTRE FOR DNA FINGERPRINTING AND DIAGNOSTICS, HYDERABAD					
P-114: DBT Project on "EVALUATING THE CALCINEURIN-NFAT PATHWAY AND ITS REGULATORS SUPEROXIDE DISMUTASE (SOD) AND RCAN1 (REGULAR OF CALCINEURIN) DOWN SYNDROME"					
P.I. Dr GAYATRI RAMAKRISHNA					
RECEIPTS AND PAYMENTS ACCOUNT FROM 01.04.2011 TO 31.03.2012					
Previous Year Amount Rs	Receipts	Current Year Amount Rs.	Previous Year Amount Rs	Payments	Current Year Amount Rs
0.00	Opening Balance	1532761.00	37239.00	Salaries- Manpower	187200.00
2070000.00	Grant in aid	0.00	500000.00	Consumables	1000000.00
			0.00	Contingencies	0.00
			0.00	Travel	0.00
			0.00	Overheads	0.00
			0.00	Equipment	294008.00
2070000.00		1532761.00	537239.00	Closing Balance	1481208.00
			1532761.00		51553.00
2070000.00		1532761.00	2070000.00		1532761.00

CENTRE FOR DNA FINGERPRINTING AND DIAGNOSTICS, HYDERABAD P-115: Setting up the National Institute of Animal Biotechnology at Hyderabad RECEIPTS AND PAYMENTS ACCOUNT FROM 01.04.2011 TO 31.03.2012					
Previous Year Amount Rs	Receipts	Current Year Amount Rs.	Previous Year Amount Rs	Payments	Current Year Amount Rs
0.00	Opening Balance	4559305.00	291680.00	Salaries- Manpower	3276411.00
5000000.00	Grant in aid	65500000.00	0.00	Consumables	6778000.00
			0.00	Contingencies	4083820.00
			0.00	Travel	1301119.00
			149015.00	Equipment	4580214.00
			0.00	Project funds transferred	42000000.00
5000000.00		70059305.00	440695.00	Closing Balance	62019564.00
5000000.00		70059305.00	4559305.00		8039741.00
			5000000.00		70059305.00

CENTRE FOR DNA FINGERPRINTING AND DIAGNOSTICS, HYDERABAD P-116: DBT-India and AIST - Japan : UNDERSTANDING MOLECULAR MECHANISMS CONTROLLING DUAL ROLE OF RAS, SIRTUINS AND CARF IN RELATION TO CELLULARPROLIFERATION AND SENESCENCE: NOVEL STRATEGY FOR DEVELOPING CANCER THERAPEUTICS P.I. Dr GAYATRI RAMAKRISHNA RECEIPTS AND PAYMENTS ACCOUNT FROM 01.04.2011 TO 31.03.2012					
Previous Year Amount Rs	Receipts	Current Year Amount Rs.	Previous Year Amount Rs	Payments	Current Year Amount Rs
0.00	Opening Balance	1692817.00	32709.00	Salaries- Manpower	71961.00
2037200.00	Grant in aid	0.00	300000.00	Consumables	1000000.00
			0.00	Contingencies	1000000.00
			11674.00	Travel	9276.00
			0.00	Overheads	0.00
			0.00	Equipment	800000.00
2037200.00	Excess of expenditure over income	1692817.00	344383.00	Closing Balance	1981237.00
2037200.00		1981237.00	1692817.00		1981237.00
			2037200.00		

<p align="center">CENTRE FOR DNA FINGERPRINTING AND DIAGNOSTICS, HYDERABAD P-117: DBT Project on "JOINT NEW INDIGO ERA-NET PROJECT TITLED "MYCOBACTERIUM TUBERCULOSIS : BIOINFORMATIC AND STRUCTURAL STRATEGIES TOWARDS TREATMENT" PI. Dr SHEKHAR C MANDE</p>					
<p align="center">RECEIPTS AND PAYMENTS ACCOUNT FROM 01.04.2011 TO 31.03.2012</p>					
Previous Year Amount	Receipts	Current Year Amount	Previous Year Amount	Payments	Current Year Amount
0.00	Opening Balance	5251500.00	0.00	Salaries- Manpower	138667.00
5593000.00	Grant in aid	0.00	200000.00	Consumables	300000.00
			25000.00	Contingencies	25000.00
			66500.00	Travel	140754.00
			50000.00	Overheads	50000.00
			0.00	Equipment	0.00
			341500.00	Project funds transferred	4597079.00
5593000.00		5251500.00	5251500.00	Closing Balance	5251500.00
5593000.00		5251500.00	5593000.00		5251500.00

<p align="center">CENTRE FOR DNA FINGERPRINTING AND DIAGNOSTICS, HYDERABAD P-118: DST Project on "CONSTRUCTION OF REGULATORY NETWORKS IN MYCOBACTERIUM TUBERCULOSIS THROUGH ANALYSIS OF GENE EXPRESSION DATA AND TRANSCRIPTION REGULATION PREDICTIONS. (MOU WITH RUSSIAN FOUNDATION)" PI. Dr SHEKHAR C MANDE</p>					
<p align="center">RECEIPTS AND PAYMENTS ACCOUNT FROM 01.04.2011 TO 31.03.2012</p>					
Previous Year Amount	Receipts	Current Year Amount	Previous Year Amount	Payments	Current Year Amount
0.00	Opening Balance	1115770.00	0.00	Salaries- Manpower	227877.00
1400770.00	Grant in aid	0.00	200000.00	Consumables	300000.00
			15000.00	Contingencies	10000.00
			20000.00	Travel	98968.00
			50000.00	Overheads	35280.00
			0.00	Equipment	183443.00
			285000.00	Project funds transferred	260202.00
1400770.00		1115770.00	1115770.00	Closing Balance	1115770.00
1400770.00		1115770.00	1400770.00		1115770.00

<p style="text-align: center;">CENTRE FOR DNA FINGERPRINTING AND DIAGNOSTICS, HYDERABAD P-119: DBT Project on "ANALYSIS OF DNA COPY NUMBER ALTERATIONS IN ESOPHAGEAL CANCER" P.I. Dr M D BASHYAM RECEIPTS AND PAYMENTS ACCOUNT FROM 01.04.2011 TO 31.03.2012</p>						
Previous Year Amount	Receipts	Current Year Amount	Previous Year Amount	Payments	Current Year Amount	
0.00	Opening Balance	560342.00	24658.00	Salaries- Manpower	247000.00	
800000.00	Grant in aid	0.00	200000.00	Consumables	1000000.00	
			150000.00	Contingencies	350000.00	
			0.00	Travel	16947.00	
			0.00	Overheads	0.00	
			0.00	Equipment	0.00	
800000.00	Excess of expenditure over income	560342.00	239658.00		1298947.00	
		738605.00	560342.00	Closing Balance		
800000.00		1298947.00	800000.00		1298947.00	

<p style="text-align: center;">CENTRE FOR DNA FINGERPRINTING AND DIAGNOSTICS, HYDERABAD P-120: DBT Project on "EFFECT OF REACTIVE OXYGEN SPECIES ON MACROPHAGE SIGNALOSOME: IMPACT ON ANTIGEN PRESENTATION FUNCTIONS AND T CELL PRIMING RESPONSES" P.I. Dr SANGITA MUKHOPADHAYAY RECEIPTS AND PAYMENTS ACCOUNT FROM 01.04.2011 TO 31.03.2012</p>						
Previous Year Amount	Receipts	Current Year Amount	Previous Year Amount	Payments	Current Year Amount	
0.00	Opening Balance	617000.00	0.00	Salaries- Manpower	62400.00	
827000.00	Grant in aid	0.00	200000.00	Consumables	400000.00	
			100000.00	Contingencies	300000.00	
			0.00	Travel	0.00	
			0.00	Overheads	0.00	
			0.00	Equipment	0.00	
827000.00		617000.00	210000.00		492400.00	
			617000.00	Closing Balance	124600.00	
827000.00		617000.00	827000.00		617000.00	

CENTRE FOR DNA FINGERPRINTING AND DIAGNOSTICS, HYDERABAD P-121: DBT Project on "IDENTIFICATION AND CHARACTERIZATION OF PTEN REGULATORS" P.I. Dr M SUBBA REDDY RECEIPTS AND PAYMENTS ACCOUNT FROM 01.04.2011 TO 31.03.2012						
Previous Year Amount Rs	Receipts	Current Year Amount Rs.	Previous Year Amount Rs	Payments	Current Year Amount Rs	
0.00	Opening Balance	37096.00	120774.00	Salaries- Manpower	187200.00	
345776.00	Grant in aid	0.00	158350.00	Consumables	400000.00	
			23600.00	Contingencies	25000.00	
			5956.00	Travel	12082.00	
			0.00	Overheads	10000.00	
			0.00	Equipment	0.00	
345776.00	Excess of expenditure over income	37096.00	308680.00		634282.00	
		597186.00	37096.00	Closing Balance		
345776.00		634282.00	345776.00		634282.00	

268

CENTRE FOR DNA FINGERPRINTING AND DIAGNOSTICS, HYDERABAD P-122: WT-DBT Alliance Project on "UNDERSTANDING THE ROLE OF HOX GENES IN ANTERIOR-POSTERIOR AXIS DETERMINATION OF THE CENTRAL NERVOUS SYSTEM" P.I. Dr Rohit Joshi RECEIPTS AND PAYMENTS ACCOUNT FROM 01.04.2011 TO 31.03.2012						
Previous Year Amount Rs	Receipts	Current Year Amount Rs.	Previous Year Amount Rs	Payments	Current Year Amount Rs	
0.00	Opening Balance	0.00	0.00	Salaries- Manpower	660600.00	
0.00	Grant in aid	13606258.00	0.00	Consumables	835148.00	
			0.00	Contingencies	0.00	
			0.00	Travel	0.00	
			0.00	Overheads	193383.00	
			0.00	Equipment	438084.00	
0.00		13606258.00	0.00		2127215.00	
0.00		13606258.00	0.00	Closing Balance	11479043.00	
					13606258.00	

CENTRE FOR DNA FINGERPRINTING AND DIAGNOSTICS, HYDERABAD P-123: Establishment and Implementation of the Indo-German DST-MPG (Max Planck Society) Partner Group on Genetic Diversity Studies P.I. Dr N Madhusudan Reddy RECEIPTS AND PAYMENTS ACCOUNT FROM 01.04.2011 TO 31.03.2012						
Previous Year Amount Rs	Receipts	Current Year Amount Rs.	Previous Year. Amount Rs	Payments	Current Year Amount Rs	
0.00	Opening Balance	0.00	0.00	Salaries- Manpower	185648.00	
0.00	Grant in aid	2884810.00	0.00	Consumables	473306.00	
			0.00	Contingencies	50000.00	
			0.00	Travel	0.00	
			0.00	Overheads	0.00	
0.00		2884810.00	0.00	Equipment	101800.00	
0.00		2884810.00	0.00	Closing Balance	810754.00	
					2074056.00	
					2884810.00	

CENTRE FOR DNA FINGERPRINTING AND DIAGNOSTICS, HYDERABAD P-124: DBT Project on "PREPARATION AND CHARACTERIZATION OF PEROXOMETAL COMPOUNDS AND STUDIES AND THEIR BIOLOGICAL SIGNIFICANCE IN CELLULAR SIGNALLING" P.I. Dr Gayatri Ramakrishna RECEIPTS AND PAYMENTS ACCOUNT FROM 01.04.2011 TO 31.03.2012						
Previous Year Amount Rs	Receipts	Current Year Amount Rs.	Previous Year. Amount Rs	Payments	Current Year Amount Rs	
0.00	Opening Balance	0.00	0.00	Salaries- Manpower	111716.00	
0.00	Grant in aid	819000.00	0.00	Consumables	500000.00	
			0.00	Contingencies	40000.00	
			0.00	Travel	0.00	
			0.00	Overheads	0.00	
0.00		819000.00	0.00	Equipment	0.00	
0.00		819000.00	0.00	Closing Balance	651716.00	
					167284.00	
					819000.00	

CENTRE FOR DNA FINGERPRINTING AND DIAGNOSTICS, HYDERABAD P-125: CSIR Project on "MECHANISTIC STUDIES ON THE ROLE OF PROTEIN KINASE SNF1K IN CELL CYCLE AND CANCER" P.I. Dr. M. Subba Reddy RECEIPTS AND PAYMENTS ACCOUNT FROM 01.04.2011 TO 31.03.2012						
Previous Year Amount	Receipts	Current Year Amount	Previous Year Amount	Payments	Current Year Amount	Rs
0.00	Opening Balance	0.00	0.00	Salaries- Manpower	110000.00	
0.00	Grant in aid	764000.00	0.00	Consumables	500000.00	
			0.00	Contingencies	0.00	
			0.00	Travel	0.00	
			0.00	Overheads	0.00	
			0.00	Equipment	0.00	
0.00		764000.00	0.00	Closing Balance	610000.00	
0.00		764000.00	0.00		154000.00	
					764000.00	

CENTRE FOR DNA FINGERPRINTING AND DIAGNOSTICS, HYDERABAD P-126: DBT Project on "RHO-DEPENDENT TRANSCRIPTION TERMINATION MACHINERY: MECHANISM OF ACTION" P.I. Dr. Ranjan Sen RECEIPTS AND PAYMENTS ACCOUNT FROM 01.04.2011 TO 31.03.2012						
Previous Year Amount	Receipts	Current Year Amount	Previous Year Amount	Payments	Current Year Amount	Rs
0.00	Opening Balance	0.00	0.00	Salaries- Manpower	111548.00	
0.00	Grant in aid	2539300.00	0.00	Consumables	800000.00	
			0.00	Contingencies	30000.00	
			0.00	Travel	16137.00	
			0.00	Overheads	0.00	
			0.00	Equipment	0.00	
0.00		2539300.00	0.00	Closing Balance	957685.00	
0.00		2539300.00	0.00		1581615.00	
					2539300.00	

<p align="center">P-127: WT - DBT Alliance Project on "SYSTEMATIC STUDIES ON THE FUNCTIONAL NETWORK OF PHOSPHATASES IN CELL LIFE AND DEATH" Centre for DNA Fingerprinting and Diagnostics, Hyderabad P.I. Dr. M. Subba Reddy Receipts and Payments Account from 01.04.2011 to 31.03.2012</p>						
Previous Year Amount Rs	Receipts	Current Year Amount Rs.	Previous Year Amount Rs	Payments	Current Year Amount Rs	
0.00	Opening Balance	0.00	0.00	Salaries- Manpower	269440.00	
0.00	Grant in aid	11097596.00	0.00	Consumables	3000000.00	
			0.00	Contingencies	0.00	
			0.00	Travel	0.00	
			0.00	Overheads	549534.00	
			0.00	Equipment	2225907.00	
0.00		11097596.00	0.00	Closing Balance	6044881.00	
0.00		11097596.00	0.00		5052715.00	
					11097596.00	

<p align="center">P-128: DBT Project on "MECHANISM OF IRON ACQUISITION AND IRON HOMEOSTASIS IN AN OPPORTUNISTIC HUMAN PATHOGEN CANDIDA GLABRATA" Centre for DNA Fingerprinting and Diagnostics, Hyderabad P.I. Dr. Rupinder Kaur Receipts and Payments Account from 01.04.2011 to 31.03.2012</p>						
Previous Year Amount Rs	Receipts	Current Year Amount Rs.	Previous Year Amount Rs	Payments	Current Year Amount Rs	
0.00	Opening Balance	0.00	0.00	Salaries- Manpower	123613.00	
0.00	Grant in aid	2807200.00	0.00	Consumables	600000.00	
			0.00	Contingencies	300000.00	
			0.00	Travel	0.00	
			0.00	Overheads	0.00	
			0.00	Equipment	0.00	
0.00		2807200.00	0.00	Closing Balance	753613.00	
0.00		2807200.00	0.00		2053587.00	
					2807200.00	

CENTRE FOR DNA FINGERPRINTING AND DIAGNOSTICS, HYDERABAD						
P-129: DBT Project on "DISCOVERY OF BIOACTIVE NATURAL PRODUCTS FROM MICROBES ESPECIALLY ACTINOMYCETES IN NICHE BIOTOPES IN MANIPUR"						
P.I. Dr Shekhar C Mande						
RECEIPTS AND PAYMENTS ACCOUNT FROM 01.04.2011 TO 31.03.2012						
Previous Year Amount	Receipts	Current Year Amount	Previous Year Amount	Payments	Current Year Amount	Rs
0.00	Opening Balance	0.00	0.00	Salaries- Manpower		0.00
0.00	Grant in aid	306000.00	0.00	Consumables		0.00
			0.00	Contingencies		0.00
			0.00	Travel		0.00
			0.00	Overheads		0.00
			0.00	Equipment		0.00
0.00		306000.00	0.00	Closing Balance		306000.00
0.00		306000.00	0.00			306000.00

272

CENTRE FOR DNA FINGERPRINTING AND DIAGNOSTICS, HYDERABAD						
P-130: DBT Project on "COMPARATIVE GENETIC ANALYSIS OF SEX CHROMOSOMES AND SEX DETERMINING GENES IN SILKMOTHS"						
P.I. Dr J Nagaraju						
RECEIPTS AND PAYMENTS ACCOUNT FROM 01.04.2011 TO 31.03.2012						
Previous Year Amount	Receipts	Current Year Amount	Previous Year Amount	Payments	Current Year Amount	Rs
0.00	Opening Balance	0.00	0.00	Salaries- Manpower		0.00
0.00	Grant in aid	5987000.00	0.00	Consumables		1750000.00
			0.00	Contingencies		50000.00
			0.00	Travel		0.00
			0.00	Overheads		0.00
			0.00	Equipment		0.00
0.00		5987000.00	0.00	Closing Balance		1800000.00
0.00		5987000.00	0.00			5987000.00

CENTRE FOR DNA FINGERPRINTING AND DIAGNOSTICS, HYDERABAD						
P-131: DBT Project on "STRUCTURAL AND FUNCTIONAL STUDIES OF ACYL COA BINDING PROTEINS FROM PLASMODIUM FALCIPARUM"						
P.I. Dr Akash Ranjan						
RECEIPTS AND PAYMENTS ACCOUNT FROM 01.04.2011 TO 31.03.2012						
Previous Year Amount	Receipts	Current Year Amount Rs.	Previous Year. Amount Rs	Payments	Current Year Amount Rs	
0.00	Opening Balance	0.00	0.00	Salaries- Manpower	41265.00	
0.00	Grant in aid	1899200.00	0.00	Consumables	650000.00	
			0.00	Contingencies	25000.00	
			0.00	Travel	0.00	
			0.00	Overheads	0.00	
0.00		1899200.00	0.00	Equipment	0.00	
0.00		1899200.00	0.00	Closing Balance	716265.00	
					1182935.00	
					1899200.00	

CENTRE FOR DNA FINGERPRINTING AND DIAGNOSTICS, HYDERABAD						
P-132: DBT Project on "CHARACTERIZATION OF TUMOR SUPPRESSOR FUNCTION OF ARIDIB, A COMPONENT OF THE HUMAN SWI/SNF CHROMATIN REMODELLING COMPLEX"						
P.I. Dr M D Bashyam						
RECEIPTS AND PAYMENTS ACCOUNT FROM 01.04.2011 TO 31.03.2012						
Previous Year Amount	Receipts	Current Year Amount Rs.	Previous Year. Amount Rs	Payments	Current Year Amount Rs	
0.00	Opening Balance	0.00	0.00	Salaries- Manpower	84877.00	
0.00	Grant in aid	929200.00	0.00	Consumables	200000.00	
			0.00	Contingencies	10000.00	
			0.00	Travel	0.00	
			0.00	Overheads	0.00	
0.00		929200.00	0.00	Equipment	0.00	
0.00		929200.00	0.00	Closing Balance	294877.00	
					634323.00	
					929200.00	

CENTRE FOR DNA FINGERPRINTING AND DIAGNOSTICS, HYDERABAD P-133: DBT Project on "INVESTIGATING THE ROLE OF HOX GENE DEFORMED IN CENTRAL NERVOUS SYSTEM PATTERNING IN DROSOPHILA MELANOGASTER" P.I. Dr Rohit Joshi RECEIPTS AND PAYMENTS ACCOUNT FROM 01.04.2011 TO 31.03.2012						
Previous Year Amount Rs	Receipts	Current Year Amount Rs.	Previous Year. Amount Rs	Payments	Current Year Amount Rs	
0.00	Opening Balance	0.00	0.00	Salaries- Manpower	0.00	
0.00	Grant in aid	1849000.00	0.00	Consumables	300000.00	
			0.00	Contingencies	0.00	
			0.00	Travel	0.00	
			0.00	Overheads	0.00	
0.00		1849000.00	0.00	Equipment	0.00	
0.00		1849000.00	0.00	Closing Balance	300000.00	
					1549000.00	
					1849000.00	

CENTRE FOR DNA FINGERPRINTING AND DIAGNOSTICS, HYDERABAD P-134: DBT project on "EXPLORATION OF WILD SILK MOTH BIODIVERSITY IN MANIPUR AND THEIR GENETIC CHARACTERIZATION USING MOLECULAR MARKERS" P.I. Dr K P Arun Kumar RECEIPTS AND PAYMENTS ACCOUNT FROM 01.04.2011 TO 31.03.2012						
Previous Year Amount Rs	Receipts	Current Year Amount Rs.	Previous Year. Amount Rs	Payments	Current Year Amount Rs	
0.00	Opening Balance	0.00	0.00	Salaries- Manpower	0.00	
0.00	Grant in aid	400000.00	0.00	Consumables	131000.00	
			0.00	Contingencies	15000.00	
			0.00	Travel	0.00	
			0.00	Overheads	0.00	
0.00		400000.00	0.00	Equipment	0.00	
0.00		400000.00	0.00	Closing Balance	146000.00	
					254000.00	
					400000.00	

CENTRE FOR DNA FINGERPRINTING AND DIAGNOSTICS, HYDERABAD						
P-135: DBT Project on "SYS TB: A NETWORK PROGRAM FOR RESOLVING THE INTRACELLULAR DYNAMICS OF HOST PATHOGEN INTERACTION IN TB INFECTION"						
P.I. Dr Sanjeev Khosla						
RECEIPTS AND PAYMENTS ACCOUNT FROM 01.04.2011 TO 31.03.2012						
Previous Year Amount Rs	Receipts	Current Year Amount Rs.	Previous Year. Amount Rs	Payments	Current Year Amount Rs	
0.00	Opening Balance	0.00	0.00	Salaries- Manpower	0.00	
0.00	Grant in aid	7943200.00	0.00	Consumables	500000.00	
			0.00	Contingencies	25000.00	
			0.00	Travel	0.00	
			0.00	Overheads	0.00	
			0.00	Equipment	0.00	
0.00		7943200.00	0.00		525000.00	
0.00		7943200.00	0.00	Closing Balance	7418200.00	
			0.00		7943200.00	

CENTRE FOR DNA FINGERPRINTING AND DIAGNOSTICS, HYDERABAD						
P-136: DBT Project on "RAF KINASE - A KEY TARGET FOR MODERN-DAY THERAPY AGAINST TUMORS"						
P.I. Dr Sunil Kumar Manna						
RECEIPTS AND PAYMENTS ACCOUNT FROM 01.04.2011 TO 31.03.2012						
Previous Year Amount Rs	Receipts	Current Year Amount Rs.	Previous Year. Amount Rs	Payments	Current Year Amount Rs	
0.00	Opening Balance	0.00	0.00	Salaries- Manpower	0.00	
0.00	Grant in aid	837200.00	0.00	Consumables	0.00	
			0.00	Contingencies	0.00	
			0.00	Travel	0.00	
			0.00	Overheads	0.00	
			0.00	Equipment	0.00	
0.00		837200.00	0.00		0.00	
0.00		837200.00	0.00	Closing Balance	837200.00	
			0.00		837200.00	

CENTRE FOR DNA FINGERPRINTING AND DIAGNOSTICS, HYDERABAD P-137: SERB Project on "SIGNALING PATHWAYS INVOLVED IN DOWN REGULATION OF PROINFLAMMATORY RESPONSES BY PPE18 PROTEIN OF MYCOBACTERIUM TUBERCULOSIS: IMPLICATION OF PPE18 AS THERAPEUTICS" P.I. Dr Sangita Mukhopadhyay RECEIPTS AND PAYMENTS ACCOUNT FROM 01.04.2011 TO 31.03.2012					
Previous Year Amount Rs	Receipts	Current Year Amount Rs.	Previous Year. Amount Rs	Payments	Current Year Amount Rs
0.00	Opening Balance	0.00	0.00	Salaries- Manpower	0.00
0.00	Grant in aid	1500000.00	0.00	Consumables	0.00
			0.00	Contingencies	0.00
			0.00	Travel	0.00
			0.00	Overheads	0.00
0.00		1500000.00	0.00	Equipment	0.00
0.00		1500000.00	0.00	Closing Balance	1500000.00
			0.00		1500000.00

CENTRE FOR DNA FINGERPRINTING AND DIAGNOSTICS, HYDERABAD P-139: DBT Project on "EVALUATING THE ROLE OF SIRTUINS AND EPIGENETIC CHANGES DURING CELLULAR SENESENCE IN CONTEXT OF P53 STATUS" P.I. Dr Gayatri Ramakrishna & Dr Sanjeev Khosla RECEIPTS AND PAYMENTS ACCOUNT FROM 01.04.2011 TO 31.03.2012					
Previous Year Amount Rs	Receipts	Current Year Amount Rs.	Previous Year. Amount Rs	Payments	Current Year Amount Rs
0.00	Opening Balance	0.00	0.00	Salaries- Manpower	0.00
0.00	Grant in aid	2467200.00	0.00	Consumables	0.00
			0.00	Contingencies	0.00
			0.00	Travel	0.00
			0.00	Overheads	0.00
0.00		2467200.00	0.00	Equipment	0.00
0.00		2467200.00	0.00	Closing Balance	2467200.00
			0.00		2467200.00

CENTRE FOR DNA FINGERPRINTING AND DIAGNOSTICS, HYDERABAD P-144: University of Pittsburgh Project on "TRI-NATIONAL TRAINING PROGRAM FOR PSYCHIATRIC GENETICS" P.I. Dr Ashwin B Dalal RECEIPTS AND PAYMENTS ACCOUNT FROM 01.04.2011 TO 31.03.2012					
Previous Year Amount Rs	Receipts	Current Year Amount Rs.	Previous Year Amount Rs	Payments	Current Year Amount Rs
0.00	Opening Balance	0.00	0.00	Salaries- Manpower	0.00
0.00	Grant in aid	267184.00	0.00	Consumables	0.00
			0.00	Contingencies	0.00
			0.00	Travel	0.00
			0.00	Overheads	0.00
			0.00	Equipment	0.00
0.00		267184.00	0.00	Closing Balance	267184.00
0.00		267184.00	0.00		267184.00

CENTRE FOR DNA FINGERPRINTING AND DIAGNOSTICS, HYDERABAD COE on Genetics and Genomic of Silkworms P.I. Dr J Nagaraju RECEIPTS AND PAYMENTS ACCOUNT FROM 01.04.2011 TO 31.03.2012					
Previous Year Amount Rs	Receipts	Current Year Amount Rs.	Previous Year Amount Rs	Payments	Current Year Amount Rs
10330961.00	Opening Balance	0.00	0.00	Opening Balance	13198864.00
13680000.00	Grant in aid	22433000.00	6002999.00	Salaries- Manpower	8389307.00
			5000000.00	Consumables	3700000.00
			560000.00	Contingencies	100000.00
			862106.00	Travel	155348.00
			2900000.00	Workshop / Training	0.00
			12000000.00	Equipment Maintenance	0.00
			144242.00	Books & Journals	0.00
			0.00	Overheads	0.00
			9740478.00	Equipment	0.00
24010961.00		22433000.00	37209825.00	Closing Balance	25543519.00
13198864.00	Excess of expenditure over income	3110519.00	0.00		
37209825.00		25543519.00	37209825.00		25543519.00

<p style="text-align: center;">CENTRE FOR DNA FINGERPRINTING AND DIAGNOSTICS, HYDERABAD COE - II : DBT Project on " Centre of Excellence for Microbial Biology" P.I: Dr J Gowrishankar, Dr K Anupama, Dr Abhijit A Sardesai, Dr Ranjan Sen and Dr Shekar C Mande RECEIPTS AND PAYMENTS ACCOUNT FROM 01.04.2011 TO 31.03.2012</p>					
Previous Year Amount Rs	Receipts	Current Year Amount Rs.	Previous Year Amount Rs	Payments	Current Year Amount Rs
0.00	Opening Balance	0.00	1454733.00	Opening Balance	4591687.00
8913000.00	Grant in aid	8570000.00	6699151.00	Salaries- Manpower	7807713.00
			3000000.00	Consumables	4400000.00
			520000.00	Contingencies	520000.00
			365439.00	Travel	220300.00
			0.00	Overheads	0.00
8913000.00			1465364.00	Equipment	0.00
4591687.00		8570000.00	13504687.00		17539700.00
13504687.00	Excess of expenditure over income	8969700.00	0.00	Closing Balance	0.00
		17539700.00	13504687.00		17539700.00

फोटो गैलरी
Photo Gallery



सी डी एफ डी और भारतीय सर्वेक्षण विभाग के बीच 19 जून 2011 हुए भूमी एवं भवन
हस्तांतरण समारोह का चित्र
Land and building handover ceremony between the Survey of India (Sol, DST) and CDFD
on 19 June, 2011



21 जून 2011 को सी डी एफ डी प्रयोगशाला ब्लॉक में अग्नि शमन की कवायद करते हुए कर्मचारीगण
Fire Drill in CDFD Laboratory Block on 21 June, 2012



सी डी एफ डी परिसर में स्वतंत्रता दिवस के उपलक्ष पर झण्डा रोहण करते हुए
Flag Hoisting on the occasion of Independence day



23 अगस्त, 2011 को आण्विक अनुवांशिकी प्रयोगशाला में नैशनल इंस्टिट्यूट ऑफ एग्रोबायोलॉजिकल साइन्सिस
जापान के प्रो. काजूई मीता एवं तोशिकी तामुरा

Visit of Prof. Kazuei Mita and Prof. Toshiki Tamura from the National Institute of Agrobiological
Sciences, Japan in the Laboratory of Molecular Genetics on 23 August, 2011



14 सितंबर, 2011 को हिन्दी सप्ताह के पुरस्कार वितरण समारोह
Hindi week celebration and award distribution ceremony on 14 September, 2011



1 नवंबर, 2011 को एकाडेमिया सीनिका, ताईवान के प्रतिनिधि सी डी एफ डी के संकाय सदस्यों से
परस्पर विचार विमर्श करते हुए
Delegates from the Academia Sinica, Taiwan interacting with the faculty members
on 1 November, 2011



24 जनवरी, 2012 को हैदराबाद विश्वविद्यालय के सहयोग से आयोजित डॉ. ए.सलाम स्मारक आई आर टी जी विन्टर स्कूल सैटेलाइट व्याख्यान में उपस्थित अतिथिगण
A section of the audience during IRTG Winter School Satellite Lecture in memoriam Dr. A Salam Khan, jointly organized with the University of Hyderabad, on January 24, 2012



बेंगलुरु में 6-8 फरवरी, 2012 को आयोजित इण्डिया बायो-2012 द्वारा पोस्टर प्रस्तुति प्रतियोगिता में सी डी एफ डी-आईकेपी अध्येता श्री विजय गुणसेखरन द्वितीय पुरस्कार ग्रहण करते हुए
Mr. Vijay Gunasekaran, CDFD-IKP Fellow being conferred with second prize for poster presentation at Bangalore INDIA BIO-2012 held during 6-8 February, 2012



2 फरवरी, 2012 को श्रोतागण को संबोधित करते हुए प्रो. मार्टिन किल्लियास
Prof. Martin Killias addressing the audience on 2 February, 2012

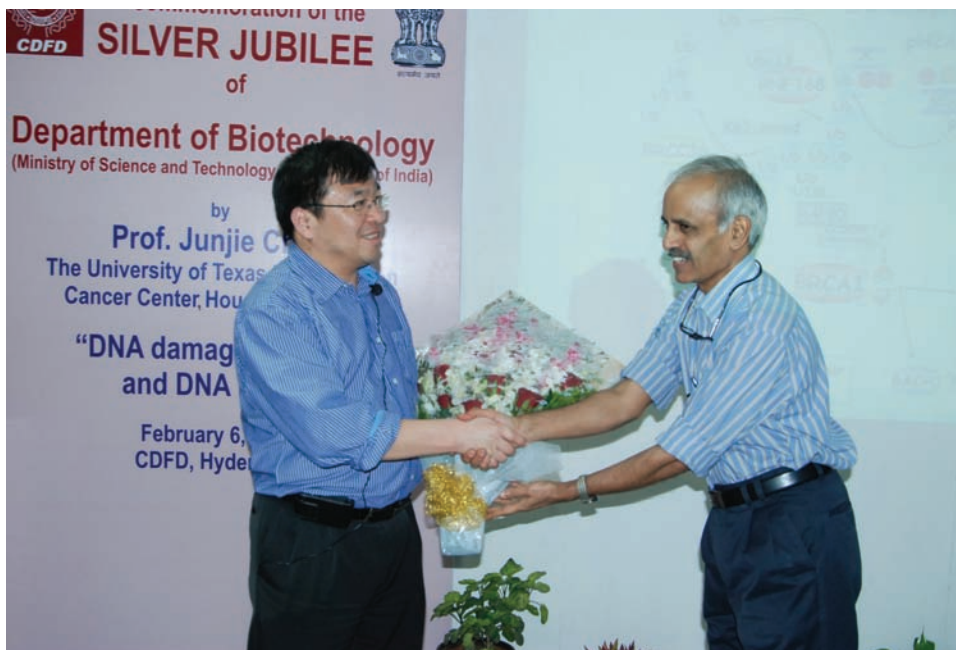

6 फरवरी, 2012 को प्रो. जून्जि चेन का स्वागत करते हुए सी डी एफ डी के निदेशक डॉ. ज. गौरीशंकर
Dr. J Gowrishankar welcoming Prof. Junjie Chen by 6 February, 2012



प्रो. तोरु शिमाडा द्वारा दिए गए भाषण के उपरांत, सी डी एफ डी के निदेशक डॉ. ज. गौरीशंकर और डॉ. जे. नागराजू के साथ वार्तालाप करते हुए कुछ जापानी अतिथिगण
 Interaction of Japanese guests with Dr. J. Gowrishankar and Dr. J. Nagaraju after the lecture by Prof. Toru Shimada on 24 February 2012



11-14 मार्च 2012 रामलिंगास्वामी फेलोज़ कॉन्क्लेव के कुछ सहभागी
 Participants of the Ramalingaswami Fellow's Conclave organized from 11-14 March 2012



सी डी एफ डी स्थापना दिवस समारोह के कुछ दृश्य
 A glimpse of the CDFD Foundation Day celebrations

NOTES / REMARKS
